

Contents

Chapter 1 Safety Requirement and Cautions	3
1.1 Safety Definition	3
1.2 Safety Requirements and Cautions	3
1.3 Cautions in Using	5
1.4 Technical Specification	5
1.5 Cautions in Disposal	5
Chapter 2 Installation and Wiring	7
2.1 Dimension of VFD	7
2.2 Solar Pump Controller Wiring	8
Chapter 3 Keyboard layout and functions specification	10
3.1 Name and Function of Each Part of the Keypad	10
3.2 Name and Function of external Keypad	10
3.3 LED Status Indicator Lights	13
3.4 Keypad Operation	13
Chapter 4 Fault Diagnosis and Solution	14
Chapter 5 Parameter list	18
5.1 Safety Precautions	18
5.2 Parameter List Reading Instructions	18
5.3 Parameter Groups	18
5.4 Group F00: Environmental Application	20
5.5 Group F01: Basic Settings	22
5.6 Group F02: Motor 1 Parameters	27
5.7 Group F03: Vector Control	31
5.8 Group F04: V/F Control	38
5.9 Group F05: Input Terminals	41
5.10 Group F06: Output Terminals	49
5.11 Group F07: Running Control	55
5.12 Group F08: Auxiliary Control	59
5.13 Group F09: Auxiliary Control 2	61
5.14 Group F10: Protection Parameters	61
5.15 Group F11: Keypad Parameters	69
5.16 Group F12: Communication Parameters	74
5.17 Group F13: Process PID Control	81

5.18 Group F14: Multi-Speed and Simple PLC.....	85
5.19 Group F21: Solar Pump Special Parameters.....	90
5.20 Group C0x: Monitoring Parameters.....	93
5.21 Communication Variable Group.....	101
Chapter 6 Parameter details	111
6.1 Safety Precautions	111
6.2 Group F00: Environmental Application.....	111
6.3 Group F01: Basic Settings	115
6.4 Group F02: Motor 1 Parameters	131
6.5 Group F03: Vector Control	141
6.6 Group F04: V/F Control	158
6.7 Group F05: Input Terminals.....	166
6.8 Group F06: Output Terminals	190
6.9 Group F07: Running Control.....	207
6.10 Group F08: Auxiliary Control 1.....	219
6.11 Group F09: Auxiliary Control 2.....	225
6.12 Group F10: Protection Parameters.....	225
6.13 Group F11: Keypad Parameters	2
6.14 Group F12: Communication Parameters	11
6.15 Group F13: Process PID Control	31
6.16 Group F14: Multi-Speed and Simple PLC.....	44
6.17 Group F15: Reserved.....	59
6.18 Group F21: Solar Pump Special Parameters.....	59
Chapter 7 Operation Guidance.....	81
7.1 Asynchronous Motor Pump Drive Operation Guidance.....	81
7.2 Synchronous Motor Pump Drive Operation Guidance.....	81
7.3 PV Water Pump Features	81

Chapter 1 Safety Requirement and Cautions

To ensure safety of your health, equipment and property, please read this chapter carefully before using the frequency VFD and act in compliance with the instructions when installing, debugging, running and overhauling the frequency VFD.

1.1 Safety Definition

Danger: it will cause danger of serious injuries and even death while operating against the rules.

Caution: it will cause danger of light injuries or equipment destruction while operating against the rules.

Note: some information is useful while operating and use frequency VFD.

1.2 Safety Requirements and Cautions

●Before Installation

Danger
1. The solar pump shall be installed in restricted access cabinet or area and is accessed by qualified electric service personnel only.

Danger
1. To reduce the risk of electric shock, do not perform any servicing other than that specified in the operating instructions unless you are qualified to do so.

●Installation

Danger
1. Please install the frequency VFD on metal or other nonflammable material, and keep it away from the combustible material. Otherwise there is danger of fire.
2. No unauthorized modification to the frequency VFD; Otherwise there is danger of damaged.
3. Normal frequency VFD, which is not explosion-proof, can not be installed where with explosive gas or dust; Otherwise there is danger of explosion.

Attention
1. When two frequency VFDs are installed in the same control cabinet, please pay attention to the installing place to guarantee the effective heat dissipation.
2. When carrying the frequency VFD, ease support its bottom.

●Wiring

Danger
1. Wire is connected only when the main circuit is cut off, otherwise there is a danger of shock.
2. Wire is connected by professional person only. Otherwise there is a danger of shock.
3. Earth must be reliable. Otherwise there is a danger of shock.
4. AC power supply should not be connected with output ports U, V, W, otherwise there is a danger of damage to frequency VFD.
5. No drop of bolt, spacer, metal stick, conducting wire or other things into the inner of frequency VFD; Otherwise there is a danger of fire or damage to frequency VFD.

Attention
1. If the damage to frequency VFD or other equipment is caused by improper wiring and utilization or unauthorized alteration, the user should shoulder all responsibilities.
2. Please make sure all wirings meet EMC requirement and satisfy safety standard in the local area; Please refer to recommendations in this manual or national standards of wire diameter to avoid accidents.
3. Static electricity on human body would seriously damage internal MOS transistor, etc. No touch the printed circuit boards, IGBT or other internal devices without anti-static measure, otherwise it will cause the malfunction of frequency VFD.
4. Please don't connect phase shifter capacitance or LC/RC noise filter to the output circuit of frequency VFD; Otherwise it will damage the frequency VFD.
5. Please don't connect the magnetic switch or magnetic contactor to the output circuit of frequency VFD; When frequency VFD is in the operation with load, magnetic switch or magnetic contactor can make VFD over-current protection function act. It will damage frequency VFD seriously.
6. Please don't disassemble the panel cover, it only needs to disassemble the terminal cover when wiring.
7. It is forbidden to do any pressure test on frequency VFD, otherwise it will damage the frequency VFD.

●Before Electrification

Danger
1. Please make sure that voltage grade of power supply is consistent with frequency VFD's voltage and then check whether the wiring is correct and firm, and whether there is short circuit in peripheral equipment's circuit. Otherwise it will damage frequency VFD and other equipment.
2. Before the frequency VFD is connected to the input power supply, make sure that the cover has been well

fixed. Otherwise it will cause electric shock.
3. For the frequency VFDs whose storage time is over 1 year, when electrification, the voltage should be raised by booster from low to high. Otherwise it will damage the frequency VFD.

Attention

1. Check if all periphery fittings are wired properly according to the handbook; Otherwise it will cause accidents.

● **After Electrification**

Danger

1. After electrified, it is forbidden to open the cover, make wiring, and check up; Otherwise, it will cause the danger of electric shock.
2. After electrified, it is forbidden to contact internal wiring board and its parts. Otherwise it will cause the danger of electric shock.
3. Do not operate or touch frequency VFD with wet hand. Otherwise there is danger of damage to frequency VFD and electric shock.

Attention

1. Please set the parameter of frequency VFD cautiously; Otherwise it will damage equipment.

●Operation

Danger
1. Before running, please check and confirm the application range of the machine and equipment once more; Otherwise it will cause accidents.
2. Please don't touch the cooling fan and braking resistance to check the temperature; Otherwise there is a danger of getting burn.
3. Unprofessional workers are banned to check the signals in the running stage; Otherwise it will cause injuries and damage the equipment.

Attention
1. Please don't turn off the equipment by switching off power; Please cut off the power supply after the electric machine stops running; Otherwise it will damage the frequency VFD.
2. Please avoid anything dropping into the equipment when the frequency VFD is running; Otherwise it will cause electric shock.

●Maintenance

Danger
1. Please don't maintain and repair the equipment with electric; Otherwise it will cause electric shock.
2. Before maintaining and repairing the frequency VFD, please make sure the indicator lights of power supply have completely turned off; Otherwise it may cause electric shock and damage the frequency VFD.
3. Persons who have not passed specialized train are not allowed to conduct the frequency VFD maintenance; Otherwise it may cause electric shock and damage the frequency VFD.

1.3 Cautions in Using

- In application of this series frequency VFD, you have to confirm all machine insulation to prevent damage to the equipment. Moreover, when the motor working in tough environment, please periodic inspect the electrical insulation to ensure the safety of the system work.
- If the motor adapter is not consistent with frequency VFD's rating current (The rating current of the motor is far smaller than that of frequency VFD), please adjust the protective value to ensure safe running.
- In occasions such as load raises, usually there is negative torque and frequency VFD breaks off for over-current or over-voltage. In this case, you should consider choosing the matching brake unit.
- Frequency VFD, in a certain output frequency range, can meet the mechanical resonance of the load equipment. To avoid it, you can set up jumping frequency.
- As output voltage of the VFD is pulse-wave type, if there is capacity which can improve power factor or pressure-sensitive resistance which used for thunder-proof in the voltage output side, the frequency VFD will break off or its parts will be damaged, so it is necessary to dismantle them. Moreover, it is proposed not install switch parts like air switch and contactor (if it is necessary to install switch on output side, please make sure the output electricity of frequency VFD is zero when the switch is working).
- At over 1,000 meters altitude, the VFD's heat dissipation function worsened due to the thin air, it is necessary to use less.
- The VFD output voltage is pulse wave type. If using digital multi-meter measurement, deviation of the reading will be great. And the deviation is different by using different type of digital multi-meter. Under normal circumstances, while RMS 380V, digital multi-meter reading is around 450V.
- Solar panel can be connected in the series or parallel. For rated voltage 380V controller, we suggest working voltage between 480V and 560V while MPPT. What means the solar panel open circuit voltage should be between 600V and 700V.

1.4 Technical Specification

Solar pump VFD power(kW)	Pump		Max solar power input (kW)	Max DC input voltage V	Recommend Voc voltage (V)	Rated output current (A)	Output frequency(Hz)
	Rated power (kW)	Rated voltage (V)					
SI21-D1 series, 60VDC~400VDC input, 3 phase 110VAC~230VAC output							
0.75	0.75	110	1.0	400	175~380	7A	0~600
1.5	1.5	110	1.95	400	175~380	10A	0~600
SI21-D3 series, 150VDC~450VDC input, 3 phase 220VAC~240VAC output							
0.75	0.75	220	1.0	450	360~430	4A	0~600
1.5	1.5	220	1.95	450	360~430	7A	0~600
2.2	2.2	220	2.86	450	360~430	10A	0~600
SI21-D5 series, 250VDC~780VDC input, 3 phase 380VAC~460VAC output							
0.75	0.75	380	1.0	780	620~750	3.0	0~600
1.5	1.5	380	2.2	780	620~750	4.0	0~600
2.2	2.2	380	3.3	780	620~750	5.0	0~600
4	4	380	5.6	780	620~750	9.5	0~600
5.5	5.5	380	8	780	620~750	13	0~600
7.5	7.5	380	11.25	780	620~750	17	0~600
11	11	380	16.5	780	620~750	25	0~600
15	15	380	22.5	780	620~750	32	0~600
18	18	380	27	780	620~750	38	0~600
22	22	380	33	780	620~750	45	0~600

1.5 Cautions in Disposal

When you dispose frequency VFD, please pay attention to:

1. Electrolytic capacitor: the electrolytic capacitor of main circuit or the printing plate may explode when they are burned.
2. Plastic: plastic incineration may generate toxic gases.
3. Dispose method: please dispose as industrial waste.

Chapter 2 Installation and Wiring

2.1 Dimension of VFD

Overall Dimension of VFD (Plastic)

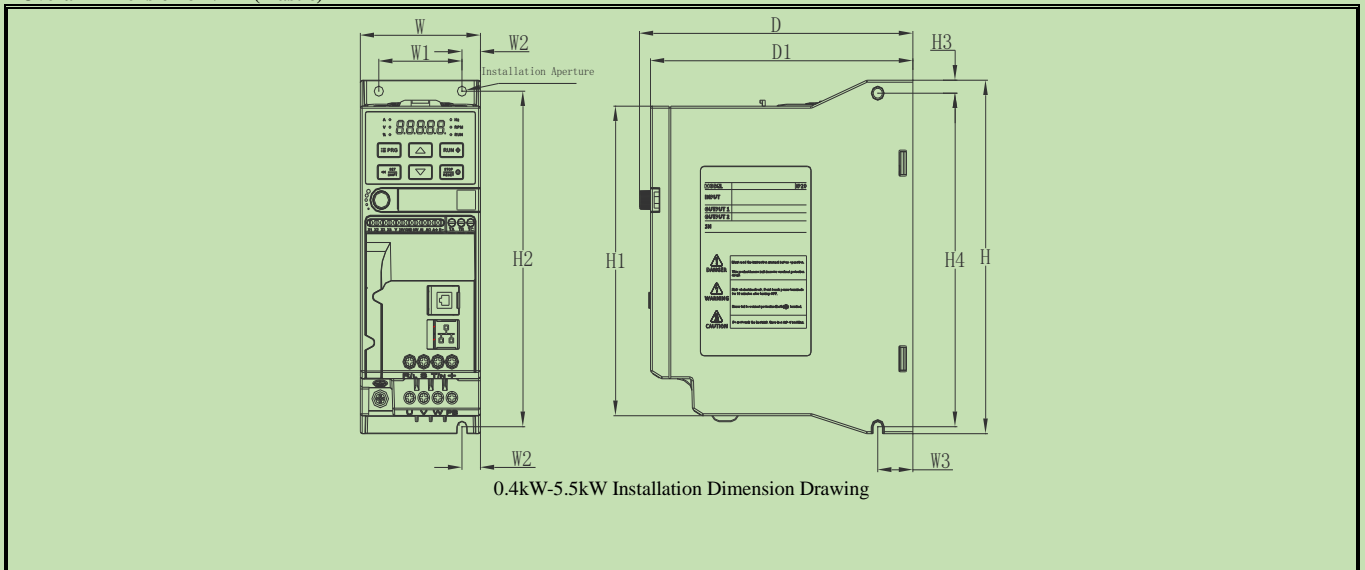

Model	Dimension (mm)					Positive mounting dimensions (mm)			Side mounting dimensions (mm)			Mounting hole diameter
	W	H	H1	D	D1	W1	W2	H2	W3	H3	H4	
SI21-D3-R04G-A	65	177	155	148	142	45	10	168	19	6.5	167	3-M4
SI21-D3-R75G-A												
SI21-D3-R75G-A-VC												
SI21-D3-1R5G-A	75	202	180	163	157	55	10	193	19	6.5	192	3-M4
SI21-D3-2R2G-A												
SI21-D3-1R5G-A-VC												
SI21-D3-2R2G-A-VC	65	177	155	148	142	45	10	168	19	6.5	167	3-M4
SI21-D5-R75G-A												
SI21-D5-1R5G-A												
SI21-D5-2R2G-A	75	202	180	163	157	55	10	193	19	6.5	192	3-M4
SI21-D5-004G-A												
SI21-D5-5R5G-A												

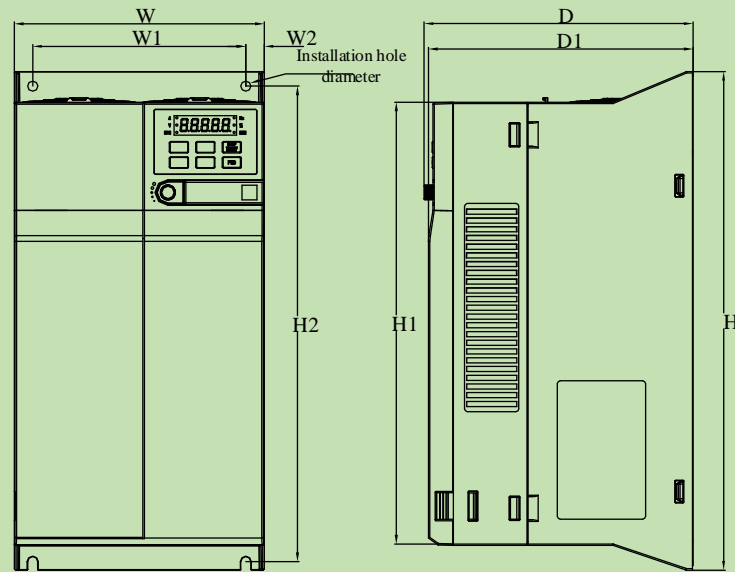

7.5kW-22kW Installation Dimension Drawing

Model	Dimension (mm)					Positive mounting dimensions (mm)			Side mounting dimensions (mm)			Mounting hole diameter
	W	H	H1	D	D1	W1	W2	H2	W3	H3	H4	
SI21-D5-7R5G-A	130	320	286	161	158	105	12.5	302	—	—	—	M5
SI21-D5-011G-A												
SI21-D5-015G-A	170	342.5	303.5	183	180	145	12.5	326.5	—	—	—	M6
SI21-D5-018G-A												
SI21-D5-022G-A												

2.2 Solar Pump Controller Wiring

- Standard Connection Diagram

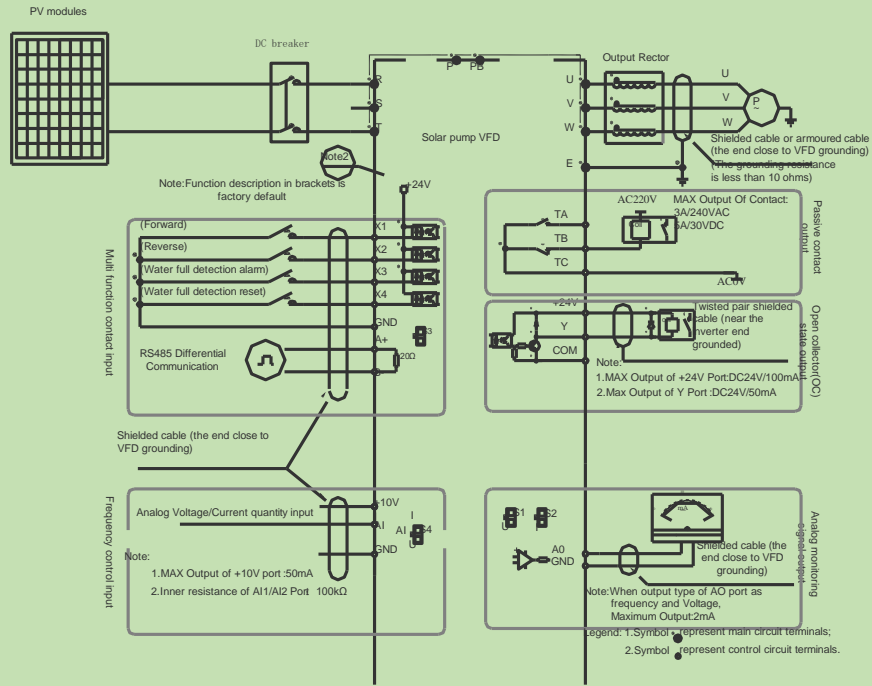

Note: When connect solar panel, please select R/T terminals.

● Auxiliary Terminal Output Capacity

Terminal	Function Definition	Max Output
+10V	10V auxiliary power supply output, constitutes loop with	50mA
AO	Analog monitor output, constitutes loop with GND.	Max output 2mA as frequency, voltage signal
+24V	24V auxiliary power supply output, constitutes loop with	100mA
Y	Collector open circuit output; can set the action-object by program.	DC24V/50mA
TA/TB/TC	Passive connector output; can set the action-object by program.	3A/240VAC 5A/30VDC

Chapter 3 Keyboard layout and functions specification

3.1 Name and Function of Each Part of the Keypad

• Keyboard Appearance



• Key Function

Key	Name	Function
	Menu key	Enter menu while standby or running. Presses this key to return while modify parameter. While standby or running, press for 1 sec to enter condition monitoring interface.
	Confirm/Shift key	Press to modify parameter while in menu interface. Press again to confirm after modifying; Press this key for 1 Sec to shift digit, and long press to cycle. Each digit flashes three time to shift to next digit.
	Up/down key	Select parameter group in menu interface. Modify parameter in modify state. Modify given frequency, ID given while at standby or monitoring state (While given frequency, PID are set by keyboard and [F4.09] needs to be set.
	Run key	While run/stop is controlled by keyboard, press this key, VFD forward runs, and the indicator is always on. While reverse, the indicator sparks.
	Stop/reset key	Machine stops if press it while run/stop is controlled by keyboard. Its efficiency range is defined by [F4.08]. VFD resets if press it in fault state (no reset if fault is not solved).

3.2 Name and Function of external Keypad

• Keypad name

Built-in single-line keypad
keypad
(for inverters with 37 kW and below)

Built-in dual-line keypad
(for inverters above 37 kW)

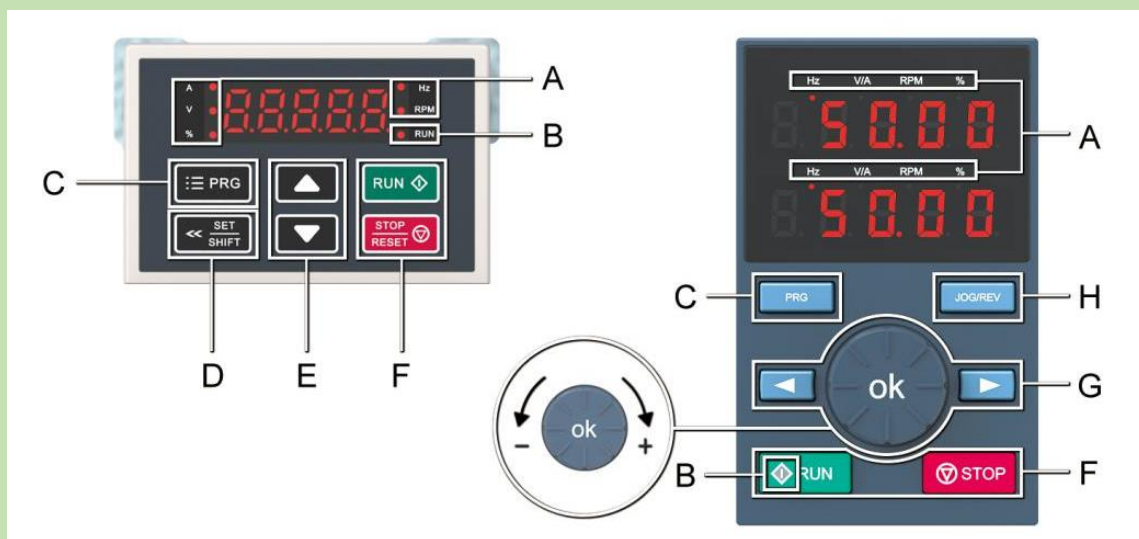

• Keypad functions

Symbol	Built-in single-line keypad	Built-in dual-line keypad	Function
--------	-----------------------------	---------------------------	----------















A	Unit indicator		Hz: Frequency A: Current V: Voltage A/V: Current or Voltage RPM: Revolutions Per Minute %: Percentage
B	Status indicator		On: Forward running status Blinking: Reverse running status Off: Stop status
C	Menu button 	Menu button 	Press to enter the function menu interface in standby or running status; press this button to exit the modification in parameter modification state; press and hold (for 1 second) this button to directly enter the status interface in standby or running status.
D	Set/Shift button 		Set function: After changing the value, press this button to confirm the change. Shift function: Press and hold (for 1 second) this button to move the operating position; press and hold to perform cyclic shift.
E	Up and down buttons 		Press Up button to increase the operation value, and the Down button to decrease the operation value.
F	Run button 	Run button 	When the run/stop function is controlled by the keypad, press this button and the inverter will run forward. The status indicator is always on for forward running, and blinking for reverse running.
	Stop/Reset button 	Stop/Reset button 	When the given command channel is controlled by keypad, press this button to stop the inverter; you can define whether other command channels are valid through the parameter [F11.03]; press this button in the fault state to reset the inverter.
G			Digital potentiometer: Turn clockwise to increase the operating value; turn counterclockwise to decrease the operating value.
		Left shift and right shift buttons 	OK button: Press this button after modifying the value to confirm the modification. Move the operating position leftward and rightward.
H		Jog/Reverse 	Select the function of this button by parameter [F11.02].





Table 3-1: Digit/Text comparison table

- Digit/Text comparison table

Word	LED display	Word	LED display	Word	LED display
0		C		O	
1		D		P	
2		E		Q	
3		F		R	
4		G		S	
5		H		T	
6		I		U	
7		J		V	
8		K		W	
9		L		X	No display
A		M		Y	
B		N		Z	No display

3.3 LED Status Indicator Lights

In the table below,  indicates that the light is on,  indicates that the light is off,  indicates that the light is blinking

Running indicator	RUN 	Off: Stop status.
	RUN 	On: Forward running.
	RUN 	Blinking: Reverse running.
Unit indicator (Hz: Frequency A: Current V: Voltage RPM: Revolutions Per Minute %: Percentage)		On: Indicate the unit of the value monitored.
		Off: Invalid.

3.4 Keypad Operation

- Setting basic parameters

Take setting F01.22 [Acceleration time 1] = 10.00 s as an example to illustrate the basic operation of the LED Keypad.

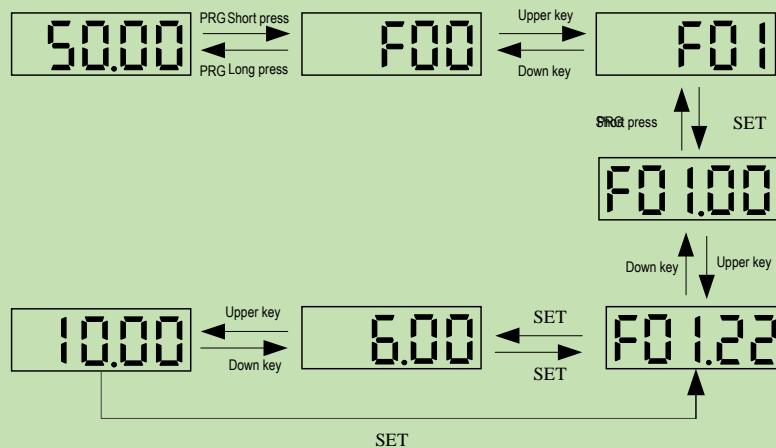

Note: Use the keypad shift buttons to quickly select the Led “00”, Led “000” and Led ”0000” of parameter values for modification.

- Viewing the running monitoring status

Take viewing the default monitoring state parameters as an example to illustrate the variable switching in the monitoring state.

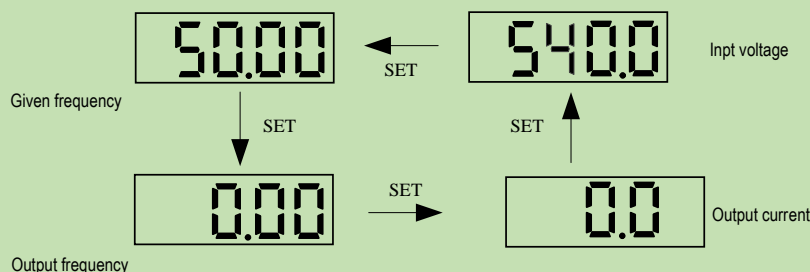

Note: For an external keypad, the left shift key is used to cycle through the first line of monitoring parameters, and the right shift key is used to cycle through the second line of monitoring parameters.









- Viewing monitoring parameters

Take viewing C02.05 [PLC running stage] as an example to illustrate the basic operation of the LED Keypad.









Chapter 4 Fault Diagnosis and Solution

This chapter describes the VFD fault, alerts, and operation of the failure on the VFD, the display information on VFD and countermeasures.

Fault Information and Description in Detail

Keypad display	Fault code	Fault type	Possibility reason	Troubleshooting
	E.LU2	Under voltage at runs	<ul style="list-style-type: none"> Power voltage too low DC main contactor don't close 	<ul style="list-style-type: none"> Check input power to solve Ask support
	E.oU1	Over voltage at acceleration	<ul style="list-style-type: none"> Power voltage fluctuation over limit Too start rotating motor 	<ul style="list-style-type: none"> Check power grid Restart until motor is stop completely, or set [F1.00] set for 1 or 2
	E.oU2	Over voltage during deceleration	<ul style="list-style-type: none"> Deceleration time too small The driving load too heavy Power voltage fluctuation over limit 	<ul style="list-style-type: none"> Prolong deceleration time Reduce the load, or select bigger capacitor drive, or connect braking unit Check input power
	E.oU3	Overvoltage at constant speed	<ul style="list-style-type: none"> The input voltage is too high An external force drives the motor during deceleration 	<ul style="list-style-type: none"> Adjust the voltage to normal range Cancel the external force or install the braking resistor
	E.oU4	Over voltage at stop	<ul style="list-style-type: none"> Voltage fluctuate above limit 	<ul style="list-style-type: none"> Check the input voltage
	E.oC1	Over current during acceleration	<ul style="list-style-type: none"> Acceleration time is too short To start rotating motor V/F setting not correct or torque boost setting too big Solar drive capacitor is too small 	<ul style="list-style-type: none"> Prolong acceleration time Restart motor when it on still, or set F1.00 for 1 or 2 Reset V/f curve or torque boost setting
	E.oC2	Over current during deceleration	<ul style="list-style-type: none"> The output circuit is grounded or short circuited. Motor auto-tuning is not performed The acceleration time is too short Manual torque boost or V/F curve is not appropriate The voltage is too low The startup operation is performed on the rotating motor A sudden load is added during acceleration The AC drive model is of too small power class 	<ul style="list-style-type: none"> Eliminate external faults Perform the motor auto tuning Increase the acceleration time Adjust the manual torque boost or V/F curve Adjust the voltage to normal range Select rotational speed tracking restart or start the motor after it stops Remove the added load. Select an AC drive of higher power class
	E.oC3	Over current at constant speed	<ul style="list-style-type: none"> The output circuit is grounded or short circuited Motor auto-tuning is not performed The voltage is too low A sudden load is added 	<ul style="list-style-type: none"> Eliminate external faults Perform the motor auto tuning Adjust the voltage to normal range Remove the added load Select an AC drive of higher

			during operation <ul style="list-style-type: none"> •The AC drive model is of too small power class 	power class
E.oL1	E.oL1	Motor overload	<ul style="list-style-type: none"> •Boost torque is too big under VF control •ACC. and DEC. time is too short •Motor parameters setting is improperly •Restart motor which in counter rotate •The grid voltage is too lower •Load is too big or motor block load •AC drive selected is too load 	<ul style="list-style-type: none"> •Reduce boost torque •Increase the ACC./DEC. time •Reset motor parameters •Reduce current limit and adopt speed tracking •Check grid voltage •Check load condition •Change bigger power AC drive
E.oL2	E.oL2	AC drive overload	<ul style="list-style-type: none"> •Boost torque is too big under VF control •ACC. and DEC. time is too short •Motor parameters setting is improperly •Restart motor which in counter rotate •The grid voltage is too lower •Load is too big or motor block load •AC drive selected is too load 	<ul style="list-style-type: none"> •Reduce boost torque •increase the ACC./DEC. time •reset motor parameters •Reduce current limit and adopt speed tracking •Too check grid voltage •Too check load •change bigger power AC drive
E.SC	E.SC	System abnormal	<ul style="list-style-type: none"> •Deceleration is too short •Short circuit of solar drive output or phase output short circuit to ground •Module damage •EMC interface 	<ul style="list-style-type: none"> •Prolong acceleration time •To check peripheral equipment •Ask to support •Check the wiring layout, cable ground
E.oH1	E.oH1	VFD over-heat	<ul style="list-style-type: none"> •Temperature is too high •Air channel is blocked •Fan connection parts is loose •Fan is damaged •Temperature detection circuit fault 	<ul style="list-style-type: none"> •Make the environment meet the requirement •Clear the air channel •Check and reconnect the wire •Change the same new fan •Seek support from factory
E.oH2	E.oH2	Rectifier over-heat	<ul style="list-style-type: none"> •Temperature is too high •Air channel is blocked •Fan connection parts is loose •Fan is damaged •Temperature detection circuit fault 	<ul style="list-style-type: none"> •Make the environment meeting the requirement •Clear the air channel •Check and reconnect the wire •Change the same new fan •Seek support from factory
E.TE1	E.TE1	Motor static detection fault	<ul style="list-style-type: none"> •Detection overtime •Start static detection while motor is running •Capacitance difference is too big between motor and VFD •Motor parameter setting mistake 	<ul style="list-style-type: none"> •Check motor connection wire •Detect after motor stopping totally •Change VFD model •Reset parameter according to nameplate
E.TE2	E.TE2	Motor rotation detection fault	<ul style="list-style-type: none"> •Detect while motor is running 	<ul style="list-style-type: none"> •Detect after motor stop totally •Re-detect without load

			<ul style="list-style-type: none"> •Detect with load •Detection overtime •Capacitance difference is too big between motor and VFD •Motor parameter setting mistake 	<ul style="list-style-type: none"> •Check motor connection wire •Change VFD model •Reset parameter according to nameplate
	E.EEP	Memory fault	<ul style="list-style-type: none"> •Electromagnetic disturb in memory period •EEPROM damage 	<ul style="list-style-type: none"> •Resume load and save •Seek support from factory
	LiFE	Reserved		
	E.iLF	Input phase loss	<ul style="list-style-type: none"> •3-phase input power open phase 	<ul style="list-style-type: none"> •Check 3-phase power supply and the phase •Check 3-phase power supply wiring
	E.oLF	Output phase loss	<ul style="list-style-type: none"> •3-phase output power open phase 	<ul style="list-style-type: none"> •Check 3-phase output voltage and current •Check wiring
	E.Gnd	Output earth terminal short circuit.	<ul style="list-style-type: none"> •Check wiring and insulation 	<ul style="list-style-type: none"> •Output earth
	E.HAL	Current detection fault	<ul style="list-style-type: none"> •Detect circuit fault •Phase imbalance 	<ul style="list-style-type: none"> •Seek support from factory •Check motor and wiring
	E.PAn	Keyboard connect fault	<ul style="list-style-type: none"> •Keyboard wire fault •Keyboard component damage 	<ul style="list-style-type: none"> •Check keyboard wire •Seek support from factory
	E.CE	<ul style="list-style-type: none"> •Unsuitable baud rate setting •Communication wire breaks •Communication format does not match upper machine. 	<ul style="list-style-type: none"> •Set suitable baud rate setting •Check communication wire. •Make sure right communication format 	<ul style="list-style-type: none"> •RS485communication fault
	E.CPE	Parameter copy fault	<ul style="list-style-type: none"> •Parameter copy communication is fault •Copy keyboard does not match the VFD 	<ul style="list-style-type: none"> •Check wire •Select the specified external keyboard model

Alarm Information and Description in Detail

Keypad display	Alarm code	Alarm type	Possibility reason	Troubleshooting
	A.LPn	Dormancy Protection	<ul style="list-style-type: none"> •Solar voltage is too low 	<ul style="list-style-type: none"> •Check the solar power •Check F21.11/F21.12/F21.13 settings
	A.LFr	Low Frequency Protection	<ul style="list-style-type: none"> •Output frequency is too low •Solar power is not enough 	<ul style="list-style-type: none"> •Check the solar power •Check F21.14/F21.15/F21.16 settings
	A.LuT	Dry Run Protection	<ul style="list-style-type: none"> •Current is very low •Pump load is very low •Water is not enough in borehole 	<ul style="list-style-type: none"> •Please check the water level in borehole •Check F21.17/F21.18/F21.19 settings
	A.Old	Pump Over Current Protection	<ul style="list-style-type: none"> •Current is higher than set 	<ul style="list-style-type: none"> •Check the pump load •Check F21.20/F21.21/F21.22 settings

	A.LPr	Minimum Power Protection	●Output power is very low	<ul style="list-style-type: none"> ●Check the solar power ●Check F21.23/F21.24/F21.25 settings
	A.FuL	Water Fulfilled Protection	●Water tank is fulfilled	<ul style="list-style-type: none"> ●Please check the water tank ●Check F21.27/F21.28
	Clear	Pump Cleaning	●Pump cleaning process	
A.LU1	A.LU1	Bus voltage too low	Bus voltage too low	Check if the AC or DC voltage is sufficient

Chapter 5 Parameter list

5.1 Safety Precautions

Danger

Please follow all the safety instructions in this manual.

Failure to follow the precautions may result in death or serious injury. Please be cautious. We will not take any responsibility for personal injuries and equipment damages caused by your company or your customers due to not complying with the contents of this Manual.

5.2 Parameter List Reading Instructions

◆ indicates an icon or term of a control mode

Icon	Description
V/F	Active parameters under V/F control mode of an asynchronous motor.
SVC	Active parameters under SVC mode of an asynchronous motor.
FVC	Active parameters under FVC mode of an asynchronous motor.
PMVF	Active parameters under V/F control mode of a synchronous motor.
PMSVC	Active parameters under SVC mode of a synchronous motor.
PMFVC	Active parameters under FVC mode of a synchronous motor.

Note: A control mode icon without shade indicates that the parameter is Invalid under the control mode.

5.3 Parameter Groups

5.3.1 Parameter Types of the Inverter

Parameter	Name	
Group F00: Environmental Application	F00.0x	Environment settings.
	F00.1x	Common parameter settings.
Group F01: Basic Settings	F01.0x	Basic commands.
	F01.1x	Frequency commands.
	F01.2x-F01.3x	Acceleration/deceleration time.
	F01.4x	PWM control.
Group F02: Motor 1 Parameters	F02.0x	Basic motor parameters and Auto-tuning selection.
	F02.1x	Advanced parameters of asynchronous motor.
	F02.2x	Advanced parameters of synchronous motor.
	F02.3x-F02.4x	Encoder parameters.
	F02.5x	Motor application parameters.
Group F03: Vector Control	F03.0x	Speed loop.
	F03.1x	Current loop and torque limits.
	F03.2x	Torque optimization control.
	F03.3x	Flux optimization.
	F03.4x-F03.5x	Torque control.
	F03.6x	PM high-frequency injection.
	F03.7x	Position compensation.
	F03.8x	extension control.

Group F04: Voltage/Frequency (V/F) Control	F04.0x	V/F control.
	F04.1x	Custom V/F curve.
	F04.2x	V/F separation control.
	F04.3x	V/F energy-saving control.
Group F05: Input Terminals	F05.0x	Digital input terminal function.
	F05.1x	Digital input terminal detection delay.
	F05.2x	Digital input terminal action selection.
	F05.3x	PUL terminal.
	F05.4x	Analog type processing.
	F05.5x	Analog linear processing.
	F05.6x	Analog input (AI) curve 1 processing.
	F05.7x	AI curve 2 processing.
F05.8x	AI as digital input terminals.	
Group F06: Output Terminals	F06.0x	Analog output (AO).
	F06.1x	Expanded AO.
	F06.2x- F06.3x	Digital and relay output.
	F06.4x	Frequency detection.
	F06.5x	Monitoring parameter comparator output.
	F06.6x- F06.7x	Virtual input and output terminals.
Group F07: Running Control	F07.0x	Start control.
	F07.1x	stop control.
	F07.2x	DC brake and speed tracking.
	F07.3x	Jog.
	F07.4x	Start and stop frequency maintenance and frequency hopping.
Group F08: Auxiliary Control 1	F08.0x	Counting and timing.
	F08.1x	Reserved
	F08.2x	Reserved
	F08.3x	Swing frequency control.
	F08.4x	Reserved
Group F09: Auxiliary Control 2	F09.0x	Maintenance function.
Group F10: Protection Parameters	F10.0x	Current protection.
	F10.1x	Voltage protection.
	F10.2x	Auxiliary protection.
	F10.3x	Load protection.
	F10.4x	Stall protection.
	F10.5x	Fault recovery and motor overload protection.
Group F11: Keypad Parameters	F11.0x	Key operation.
	F11.1x	Status interface loop monitoring.
	F11.2x	Monitoring parameter control.
	F11.3x	Special Keypad functions.
Group F12: Communication Parameters	F12.0x	Modbus slave parameters.
	F12.1x	Modbus master parameters.
	F12.2x	Modbus special functions.
	F12.3x	PROFIBUS-DP communication group.
	F12.4x	CAN communication group.
	F12.5x	Communication of extension ports EX-A and EX-B.

Group F13: Process PID Control	F13.00-F13.06	PID setting and feedback.
	F13.07-F13.24	PID regulation.
	F13.25-F13.28	PID feedback disconnection judgment.
	F13.29-F13.33	Sleep function.
Group F14: Multi-Speed and Simple PLC	F14.00-F14.14	Multi-speed frequency setting.
	F14.15	PLC running mode selection.
	F14.16-F14.30	PLC running time selection.
	F14.31-F14.45	PLC direction and acceleration/deceleration time selection.
Group F21	F21.00-F21.xx	Photovoltaic-specific function
Monitoring parameter group	C00.xx	Basic monitoring.
	C01.xx	Fault monitoring.
	C02.xx	Applications.
	C03.xx	Maintenance and tension control monitoring.
	C04.xx	Solar pump application monitoring.
	C05.xx	Control and monitoring.
	C06.xx-C07.xx	Option card monitoring parameter group.
Communication variable group	Modbus basic communication group	Communication addresses 0x3000-0x301F, 0x2000-0x201F.
	Option card basic communication group	Communication addresses 0x3100-0x311F.
	Input/output interface group	Communication addresses 0x3400-0x341F.
	Cache register group	Communication addresses 0x3500-0x350F.
	extension fault and power-off parameter group	Communication addresses 0x3600-0x361F.

5.3.2 Parameter attributes of the inverter

The adjustable attributes of parameters are described in the table below.

Adjustable Attribute of Parameter	Description
STOP	The parameter cannot be changed during running.
RUN	The parameter can be changed during running.
READ	The parameter is read only and cannot be changed.

5.4 Group F00: Environmental Application

Group F00.0x: Environment Settings

Parameter Code (Address)	Name	Description	Default (Range)	Reference Source
F00.00 (0x0000) RUN	Parameter access level	V/F SVC FVC PMVF PMSVC PMFVC Set the parameter access level according to the parameter access limitations. 0: Standard parameter (Fxx.yy, Cxx.yy) 1: Common parameter (F00.00, Pxx.yy) 2: Monitoring parameter (F00.00, Cxx.yy) 3: Parameter changed (F00.00, Hxx.yy)	0 (0~3)	F00.0x

F00.01 (0x0001) STOP	Use selection	V/F SVC FVC PMVF PMSVC PMFVC Set the inverter for the intended use. 0: General 1: Fan/water pump	0 (0~1)	
F00.02 (0x0002)	Reserved			
F00.03 (0x0003) STOP	Initialization	V/F SVC FVC PMVF PMSVC PMFVC Set the initialization mode of the inverter. 0: No initialization. 11: Initialize parameters (excluding motor parameters) according to the set point of use selection. 22: Initialize all parameters. 33: Clear fault records	0 (0~33)	
F00.04 (0x0004) STOP	Keypad parameter copy	V/F SVC 0: No function. 11: Upload parameters to the Keypad 22: Download parameters to the inverter	0 (0~30)	
F00.05 (0x0005) STOP	Reserved			
F00.06 (0x0006) RUN	Reserved			
F00.07 (0x0007) RUN	Free parameter 1	V/F SVC FVC PMVF PMSVC PMFVC Serves as the unit number when multiple units are used. Serves as the mode number for each use when multiple units are used.	0 (0~65535)	
F00.08 (0x0008) RUN	Free parameter 2	V/F SVC FVC PMVF PMSVC PMFVC Serves as the unit number when multiple units are used. Serves as the mode number for each use when multiple units are used.	0 (0~65535)	

Group F00.1x: Common Parameter Settings

Parameter Code (Address)	Name	Description	Default (Range)	Reference Source
F00.10~F00.39 (0x000A~0x0027) RUN	Common parameter address setting	V/F SVC FVC PMVF PMSVC PMFVC LED"0" and LED"00"s: Sets yy (00-99) in function parameter number Fxx.yy. LED"000" and LED"0000"s: Sets xx (00-31) in function parameter number Fxx.yy.	Determined by F00.01 (0000~2999)	F00.1x

5.5 Group F01: Basic Settings

Group F01.0x: Basic Commands

Parameter Code (Address)	Name	Description	Default (Range)	Reference Source
F01.00 (0x0100) STOP	Motor control mode	V/F SVC FVC PMVF PMSVC PMFVC Set the control mode of motor. AM: 0: AM-VF; VF control 1: AM-SVC; open-loop vector control, current closed-loop control 2: AM-FVC; closed-loop vector control PM: 10: PM-VF; VF control 11: PM-SVC; Open-loop vector control 12: PM-FVC; Closed-loop vector control POWER: 20: VF-separation: Voltage-frequency separation control (available only for T3 models of 7.5 kW or above T2 models of 5.5 kW and above).	0 (0~20)	F01.0x
F01.01 (0x0101) RUN	Run command channel	V/F SVC FVC PMVF PMSVC PMFVC Select the channel for the inverter to accept the run and stop commands and the running direction. 0: Keypad control (the external keypad takes precedence) 1: Terminal control 2: RS485 communication control 3: Option card 4: Terminal switching command given	0 (0~3)	
F01.02 (0x0102) RUN	Frequency given source channel A	V/F SVC FVC PMVF PMSVC PMFVC Set the frequency given source of the inverter. 0: Keypad digital given 1: Keypad potentiometer (optional external single-line keypad) 2: Current/voltage analog AI1 3: Current/voltage analog AI2 4: Reserved 5: Terminal pulse PUL 6: RS485 communication 7: Terminal UP/DW control 8: PID control 9: Program control (PLC) 10: Option card 11: Multi-speed	0 (0~11)	
F01.03 (0x0103) STOP	Gain of frequency given source channel A	V/F SVC FVC PMVF PMSVC PMFVC Set the gain of frequency given source channel A.	100.0% (0.0%~500.0%)	

F01.04 (0x0104) RUN	Frequency given source channel B	V/F SVC FVC PMVF PMSVC PMFVC Set the frequency given source of the inverter. Same as [F01.02]	2 (0~11)	
F01.05 (0x0105) STOP	Gain of frequency given source channel B	V/F SVC FVC PMVF PMSVC PMFVC Set the gain of frequency given source channel B.	100.0% (0.0%~500.0%)	
F01.06 (0x0106) RUN	Frequency channel B reference source	V/F SVC FVC PMVF PMSVC PMFVC Select the reference source for frequency given channel B. 0: Use the maximum output frequency as the reference source. 1: Use the set frequency of channel A as the reference source	0 (0~1)	
F01.07 (0x0107) RUN	Frequency given source selection	V/F SVC FVC PMVF PMSVC PMFVC Select the combination mode of frequency given source channel A and channel B of the inverter. 0: Channel A 1: Channel B 2: Channel A + Channel B 3: Channel A - Channel B 4: Channel A or Channel B, whichever is the larger 5: Channel A or Channel B, whichever is the smaller	0 (0~5)	
F01.08 (0x0108) RUN	Frequency given with run command binding	V/F SVC FVC PMVF PMSVC PMFVC When activated, this parameter is used to set the frequency source channel bound by each run command channel. LED "0": Keypad command binding LED "00": Terminal command binding LED "000": Communication command binding LED "0000": Option card command binding 0: No binding 1: Keypad digital given 2: Keypad potentiometer (optional external single-line keypad) 3: Current/voltage analog AI1 4: Current/voltage analog AI2 5: Reserved 6: Terminal pulse PUL 7: Communication 8: Terminal UP/DW control 9: PID control A: Program control (PLC) B: Option card C: Multi-speed D: Reserved	0000 (0000~DDDD)	
F01.09 (0x0109) RUN	Keypad digital given frequency	V/F SVC FVC PMVF PMSVC PMFVC Set and change the frequency set by the keypad digital.	50.00 Hz (0.00 - upper limit frequency)	

Group F01.1x: Frequency Command

Parameter Code (Address)	Name	Description	Default (Range)	Reference Source
F01.10 (0x010A) STOP	Maximum frequency	V/F SVC FVC PMVF PMSVC PMFVC Set the maximum frequency for the inverter.	50.00 Hz (Upper limit frequency ~500.00 Hz)	F01.1x
F01.11 (0x010B) RUN	Upper frequency limit source selection	V/F SVC FVC PMVF PMSVC PMFVC Select the reference source for the upper frequency limit of the inverter. 0: Upper limit frequency digital setting 1: Keypad potentiometer (optional external single-line keypad) 2: Current/voltage analog AI1 3: Current/voltage analog AI2 4: Reserved 5: Terminal pulse PUL 6: RS485 communication 7: Option card	0 (0~7)	
F01.12 (0x010C) RUN	Upper frequency limit digital setting	V/F SVC FVC PMVF PMSVC PMFVC Set the upper frequency limit reference channel when F01.11 is set as 0.	0.00 Hz (lower frequency limit - maximum frequency)	
F01.13 (0x010D) RUN	Lower frequency limit	V/F SVC FVC PMVF PMSVC PMFVC Set the lower frequency limit to limit the frequency setting.	0.00 Hz (0.00 - upper frequency limit)	
F01.14 (0x010E) STOP	Frequency command resolution	V/F SVC FVC PMVF PMSVC PMFVC Set the resolution of frequency commands. 0: 0.01Hz 1: 0.1Hz 2: 0.1rpm 3: 1rpm	0 (0~3)	

Group F01.2x~F01.3x: Acceleration/Deceleration Time

Parameter Code (Address)	Name	Description	Default (Range)	Reference Source
F01.20 (0x0114) STOP	Reference frequency for acceleration/deceleration time	V/F SVC FVC PMVF PMSVC PMFVC Set the reference frequency for calculating the acceleration/deceleration time. 0: Maximum frequency 1: Fixed frequency 50 Hz 2: Given frequency	0 (0~2)	F01.2x

F01.21 (0x0115) STOP	Unit of acceleration/d eceleration time	V/F SVC FVC PMVF PMSVC PMFVC Set the decimal places of acceleration/deceleration time parameters F01.22 - F01.29. 0: 1s 1: 0.1s 2: 0.01s	2 (0~2)	
F01.22 (0x0116) RUN	Acceleration time 1	V/F SVC FVC PMVF PMSVC PMFVC The time required for the output frequency to accelerate from 0.00 Hz to the time reference frequency. 0.01s~650.00s (F01.21 = 2) 0.1s~6500.0s (F01.21 = 1) 1s~65000s (F01.21 = 0)	Model setting (0.01s~ 650.00 s)	
F01.23 (0x0117) RUN	Deceleration time 1	V/F SVC FVC PMVF PMSVC PMFVC Set the time required for the output frequency to decelerate from the time reference frequency to 0.00 Hz. 0.01s~650.00s (F01.21 = 2) 0.1s~6500.0s (F01.21 = 1) 1s~65000s (F01.21 = 0)	Model setting (0.01s~ 650.00 s)	
F01.24 (0x0118) RUN	Acceleration time 2	V/F SVC FVC PMVF PMSVC PMFVC The time required for the output frequency to accelerate from 0.00 Hz to the time reference frequency.	Model setting (0.01 s~ 650.00 s)	
F01.25 (0x0119) RUN	Deceleration time 2	V/F SVC FVC PMVF PMSVC PMFVC Set the time required for the output frequency to decelerate from the time reference frequency to 0.00 Hz.	Model setting (0.01 s~ 650.00 s)	
F01.26 (0x011A) RUN	Acceleration time 3	V/F SVC FVC PMVF PMSVC PMFVC The time required for the output frequency to accelerate from 0.00 Hz to the time reference frequency.	Model setting (0.01 s~ 650.00 s)	
F01.27 (0x011B) RUN	Deceleration time 3	V/F SVC FVC PMVF PMSVC PMFVC Set the time required for the output frequency to decelerate from the time reference frequency to 0.00 Hz.	Model setting (0.01 s~ 650.00 s)	
F01.28 (0x011C) RUN	Acceleration time 4	V/F SVC FVC PMVF PMSVC PMFVC The time required for the output frequency to accelerate from 0.00 Hz to the time reference frequency.	Model setting (0.01 s~ 650.00 s)	
F01.29 (0x011D) RUN	Deceleration time 4	V/F SVC FVC PMVF PMSVC PMFVC Set the time required for the output frequency to decelerate from the time reference frequency to 0.00 Hz.	Model setting (0.01 s~ 650.00 s)	

F01.30 (0x011E) STOP	S-curve acceleration/d eceleration selection	V/F SVC FVC PMVF PMSVC PMFVC Set whether the S-curve acceleration/deceleration selection is Valid. 0: Invalid 1: Valid 2: Flexible S-curve	1 (0~2)	
F01.31 (0x011F) STOP	S-curve acceleration start time	V/F SVC FVC PMVF PMSVC PMFVC Set the S-curve acceleration start time.	0.20s (0.00s~ 10.00s)	
F01.32 (0x0120) STOP	S-curve acceleration end time	V/F SVC FVC PMVF PMSVC PMFVC Set the S-curve acceleration end time.	0.20s (0.00s~ 10.00s)	
F01.33 (0x0121) STOP	S-curve deceleration start time	V/F SVC FVC PMVF PMSVC PMFVC Set the S-curve deceleration start time.	0.20s (0.00s~ 10.00s)	
F01.34 (0x0122) STOP	S-curve deceleration end time	V/F SVC FVC PMVF PMSVC PMFVC Set the S-curve deceleration end time.	0.20s (0.00s~ 10.00s)	
F01.35 (0x0123) RUN	Frequency of switching between acceleration time 1 and acceleration time 2	V/F SVC FVC PMVF PMSVC PMFVC Set the frequency switch between acceleration time 1 and acceleration time 2.	0.00 Hz (0.00~maximu m frequency)	

Group F01.4x: PWM Control

Parameter Code (Address)	Name	Description	Default (Range)	Reference Source
F01.40 (0x0128) RUN	Carrier frequency	V/F SVC FVC PMVF PMSVC PMFVC Set the switching frequency of the inverter IGBT.	Model setting (1.0 kHz~16.0 kHz)	F01.4x
F01.41 (0x0129) RUN	PWM control mode	V/F SVC FVC PMVF PMSVC PMFVC LED "0": Relation of carrier with temperature 0: No relation with temperature 1: Related withtemperature LED "00": Relation of carrier with output frequency 0: No relation with output frequency 1: Related with output Frequency LED "000": Random PWM enabling 0: Disabled 1: Activated under V/F mode 2: Activated under vector mode LED "0000": PWM modulation mode 0: Three-phase modulation only 1: Automatic switching between two-phase and three-phase modulation	1111 (0000~1211)	
F01.43 (0x012B) RUN	Dead-time compensation gain	V/F SVC FVC PMVF PMSVC PMFVC The gain for dead-time compensation	306 (0~512)	

F01.46 (0x012E) RUN	PWM random depth	V/F SVC FVC PMVF PMSVC PMFVC The higher the setting, the greater the carrier fluctuation when random PWM is enabled.	0 (0~20)	
---------------------------	------------------	--	-------------	--

5.6 Group F02: Motor 1 Parameters

Group F02.0x: Basic Motor Parameters and Auto-tuning Selection

Parameter Code (Address)	Name	Description	Default (Range)	Reference Source
F02.00 (0x0200) READ	Motor type	V/F SVC FVC PMVF PMSVC PMFVC Set the type of motor. 0: Asynchronous motor (AM) 1: Permanent magnetic synchronous motor (PM)	0 (0~1)	F02.0x
F02.01 (0x0201) STOP	Number of motor poles	V/F SVC FVC PMVF PMSVC PMFVC Set the number of motor poles.	4 (2~48)	
F02.02 (0x0202) STOP	Rated motor power	V/F SVC FVC PMVF PMSVC PMFVC Set the motor rated power.	Model setting (0.1 kW~ 1,000.0 kW)	
F02.03 (0x0203) STOP	Rated motor frequency	V/F SVC FVC PMVF PMSVC PMFVC Set the motor rated frequency.	Model setting (0.01~ maximum frequency)	
F02.04 (0x0204) STOP	Rated motor speed	V/F SVC FVC PMVF PMSVC PMFVC Set the motor rated speed.	Model setting (0 rpm~ 65,000 rpm)	
F02.05 (0x0205) STOP	Rated motor voltage	V/F SVC FVC PMVF PMSVC PMFVC Set the motor rated voltage.	Model setting (0 V~1,500 V)	
F02.06 (0x0206) STOP	Rated motor current	V/F SVC FVC PMVF PMSVC PMFVC Set the motor rated current.	Model setting (0.1 A~ 3,000.0 A)	
F02.07 (0x0207) STOP	Selection of motor parameter auto-tuning	V/F SVC FVC PMVF PMSVC PMFVC After the parameter auto-tuning is finished, the setting of [F02.07] will be automatically set as "0". 0: No operation 1: Rotary auto-tuning 2: Static auto-tuning 3: Stator resistance auto-tuning 4-20: Reserved	0 (0~20)	

Note: When F02.00 [Motor Type] is set as "synchronous motor", F02.04 [Rated Motor Speed] is calculated by F02.01 [Number of Motor Poles] and F02.03 [Motor Rated Frequency]. Please set the parameters correctly. Formula: F02.04 [Rated motor speed] = 60 * F02.03 [Rated motor frequency]/(F02.01 [Number of motor poles]/2).

Group F02.1x: Advanced Parameters of Asynchronous Motor

Parameter Code (Address)	Name	Description	Default (Range)	Reference Source
--------------------------	------	-------------	-----------------	------------------

F02.10 (0x020A) STOP	No-load current of asynchronous motor	V/F SVC FVC PMVF PMSVC PMFVC Set the no-load current of asynchronous motor.	Model setting (0.1 A~ 3,000.0 A)	F02.1x
F02.11 (0x020B) STOP	Stator resistance of asynchronous motor	V/F SVC FVC PMVF PMSVC PMFVC Set the stator resistance of asynchronous motor.	Model setting (0.01 mΩ~ 60,000 mΩ)	
F02.12 (0x020C) STOP	Rotor resistance of asynchronous motor	V/F SVC FVC PMVF PMSVC PMFVC Set the rotor resistance of asynchronous motor.	Model setting (0.01 mΩ~ 60,000 mΩ)	
F02.13 (0x020D) STOP	Stator leakage inductance of asynchronous motor	V/F SVC FVC PMVF PMSVC PMFVC Set the stator leakage inductance of asynchronous motor.	Model setting (0.001 mH~ 6,553.5 mH)	
F02.14 (0x020E) STOP	Stator inductance of asynchronous motor	V/F SVC FVC PMVF PMSVC PMFVC Set the stator inductance of asynchronous motor.	Model setting (0.01 mH~ 65,535 mH)	
F02.15 (0x020F) READ	Stator resistance per-unit value	V/F SVC FVC PMVF PMSVC PMFVC Set the resistance per-unit value of stator.	Model setting (0.01%~ 50.00%)	
F02.16 (0x0210) READ	Rotor resistance per-unit value	V/F SVC FVC PMVF PMSVC PMFVC Set the resistance per-unit value of rotor.	Model setting (0.01%~ 50.00%)	
F02.17 (0x0211) READ	Stator leakage inductance per-unit value	V/F SVC FVC PMVF PMSVC PMFVC Set the leakage inductance per-unit value of stator.	Model setting (0.01%~ 50.00%)	
F02.18 (0x0212) READ	Stator inductance per-unit value	V/F SVC FVC PMVF PMSVC PMFVC Set the inductance per-unit value of stator.	Model setting (0.1%~ 999.0%)	
F02.19 (0x0213) READ	Decimal place selection for F02.11 - F02.14	V/F SVC FVC PMVF PMSVC PMFVC Set the decimal places of four parameters F02.11 - F02.14.	0000 (0000-2222)	

Group F02.2x: Advanced Parameters of Synchronous Motor

Parameter Code (Address)	Name	Description	Default (Range)	Reference Source
F02.20 (0x0214) STOP	Stator resistance of synchronous motor	V/F SVC FVC PMVF PMSVC PMFVC Set the stator resistance of synchronous motor.	Model setting (0.01mΩ~ 60000mΩ)	F02.2x
F02.21 (0x0215) STOP	d-axis inductance of synchronous motor	V/F SVC FVC PMVF PMSVC PMFVC Set the d-axis inductance of synchronous motor.	Model setting (0.001mH~ 6553.5mH)	
F02.22 (0x0216) STOP	q-axis inductance of synchronous motor	V/F SVC FVC PMVF PMSVC PMFVC Set the q-axis inductance of synchronous motor.	Model setting (0.001mH~ 6553.5mH)	

F02.23 (0x0217) STOP	Back-EMF of synchronous motor	V/F SVC FVC PMVF PMSVC PMFVC Set the back-EMF of synchronous motor. Only recognized during rotating auto-tuning.	Model setting (0V~1500V)	
F02.24 (0x0218) RUN	Mounting angle of synchronous motor encoder	V/F SVC FVC PMVF PMSVC PMFVC Set the mounting angle of synchronous motor encoder.	Model setting (0.0°~360.0°)	
F02.25 (0x0219) READ	Stator resistance per-unit value of synchronous motor	V/F SVC FVC PMVF PMSVC PMFVC Set the stator resistance per-unit value of synchronous motor.	Model setting (monitor value)	
F02.26 (0x021A) READ	d-axis inductance per-unit value of synchronous motor	V/F SVC FVC PMVF PMSVC PMFVC Set the d-axis inductance per-unit value of synchronous motor.	Model setting (monitor value)	
F02.27 (0x021B) READ	q-axis inductance per-unit value of synchronous motor	V/F SVC FVC PMVF PMSVC PMFVC Set the q-axis inductance per-unit value of synchronous motor.	Model setting (monitor value)	
F02.28 (0x021C) STOP	Pulse width coefficient of synchronous motor	V/F SVC FVC PMVF PMSVC PMFVC Set the pulse width coefficient of synchronous motor.	Model setting (00.00~99.99)	
F02.29 (0x021D) READ	Decimal place selection for F02.20 - F02.22	V/F SVC FVC PMVF PMSVC PMFVC Set the decimal places of three parameters F02.20 - F02.22. This parameter is read only.	0000 (0000~2222)	

Group F02.3x~F02.4x: Encoder Parameters

Parameter Code (Address)	Name	Description	Default (Range)	Reference Source
F02.30 (0x021E) STOP	Types of speed feedback encoder	V/F SVC FVC PMVF PMSVC PMFVC 0: Ordinary ABZ encoder (connected to extension port EX_B) 1: Resolver (connected to extension port EX_B)	0 (0~1)	F02.3x
F02.31 (0x021F) STOP	Encoder direction	V/F SVC FVC PMVF PMSVC PMFVC 0: In the same direction 1: In the opposite direction	0 (0~1)	
F02.32 (0x0220) STOP	ABZ encoder Z pulse detection selection	V/F SVC FVC PMVF PMSVC PMFVC 0: OFF 1: ON (positive pulse) 2: ON (negative pulse)	1 (0~2)	

F02.33 (0x0221) STOP	Number of ABZ encoder pulse	V/F SVC FVC PMVF PMSVC PMFVC Set the number of ABZ encoder pulse.	1024 (1~10000)	
F02.34 (0x0222) STOP	Number of resolver poles	V/F SVC FVC PMVF PMSVC PMFVC Set the number of resolver poles.	2 (2~128)	
F02.35 (0x0223) RUN	Encoder transmission ratio numerator	V/F SVC FVC PMVF PMSVC PMFVC Set the numerator of encoder transmission ratio.	1 (1~32767)	
F02.36 (0x0224) RUN	Encoder transmission ratio denominator	V/F SVC FVC PMVF PMSVC PMFVC Set the denominator of encoder transmission ratio.	1 (1~32767)	
F02.37 (0x0225) RUN	Encoder speed measurement filter time	V/F SVC FVC PMVF PMSVC PMFVC Set the filter time for encoder speed measurement.	1.0ms (0.0ms~100.0ms)	
F02.38 (0x0226) RUN	Encoder disconnection detection time	V/F SVC FVC PMVF PMSVC PMFVC Set the time required for encoder disconnection detection.	0.500s (0.100s~60.000s)	
F02.49 (0x0231) RUN	Encoder debug register	V/F SVC FVC PMVF PMSVC PMFVC LED"0": Monitor PG feedback under SVC mode 0: Invalid 1: Valid	0000 (0000~1111)	

Group F02.5x: Motor Application Parameters

Parameter Code (Address)	Name	Description	Default (Range)	Reference Source
F02.50 (0x0232) STOP	Stator resistance Start tuning function selection	V/F SVC FVC PMVF PMSVC PMFVC 0: Invalid 1: Turning without update >1: Turning with update	0 (0~3)	F02.5x
F02.51 (0x0233) RUN	Stator resistance Start tuning coefficient 1	V/F SVC FVC PMVF PMSVC PMFVC Stator resistance Start learning coefficient 1.	0 (0~1000)	
F02.52 (0x0234) RUN	Stator resistance Start tuning coefficient 2	V/F SVC FVC PMVF PMSVC PMFVC Stator resistance Start learning coefficient 2.	0 (-20.00% ~20.00%)	
F02.53 (0x0235) RUN	Stator resistance Start tuning coefficient 3	V/F SVC FVC PMVF PMSVC PMFVC Stator resistance Start tuning coefficient 3.	0 (0~65535)	

F02.60 (0x023C) STOP	Magnetic pole search of synchronous motor	V/F SVC FVC PMVF PMSVC PMFV LED"0": Closed-loop vector 0: OFF 1: ON 2: ON, started only for the first time on power-on LED"00": Open-loop vector 0: OFF 1: ON 2: ON, started only for the first time on power-on LED"000": VF 0: OFF 1: ON 2: ON, started only for the first time power-on	0010 (0000~3223)	
F02.61 (0x023D) STOP	Pole search current setting	V/F SVC FVC PMVF PMSVC PMFVC Set the set value of the magnetic pole search current.	0.0% (0.0%~6553.5%)	

5.7 Group F03: Vector Control

Group F03.0x: Speed Loop

Parameter Code (Address)	Name	Description	Default (Range)	Reference Source
F03.00 (0x0300) RUN	ASR speed rigidity class	V/F SVC FVC PMVF PMSVC PMFVC Set the rigidity class. The higher the class, the better the speed rigidity.	32 (1~128)	F03.0x
F03.01 (0x0301) RUN	ASR speed rigidity mode	V/F SVC FVC PMVF PMSVC PMFVC Select the ASR speed rigidity mode.	0000 (0000~FFFF)	
F03.02 (0x0302) RUN	ASR (speed loop) proportional gain 1	V/F SVC FVC PMVF PMSVC PMFVC Set the ASR (speed loop) proportional gain 1.	10.00 (0.01~100.00)	
F03.03 (0x0303) RUN	ASR (speed loop) integral time 1	V/F SVC FVC PMVF PMSVC PMFVC Set the ASR (speed loop) integral time 1.	0.100s (0.000s~6.000s)	
F03.04 (0x0304) RUN	ASR filter time 1	V/F SVC FVC PMVF PMSVC PMFVC Set the ASR filter time 1.	0.0ms (0.0ms~100.0ms)	
F03.05 (0x0305) RUN	ASR switching frequency 1	V/F SVC FVC PMVF PMSVC PMFVC Set the ASR switching frequency 1.	0.00 Hz (0.00Hz~maximum frequency)	
F03.06 (0x0306) RUN	ASR (speed loop) proportional gain 2	V/F SVC FVC PMVF PMSVC PMFVC Set the ASR (speed loop) proportional gain 2.	10.00 (0.01~100.00)	

F03.07 (0x0307) RUN	ASR (speed loop) integral time 2	V/F SVC FVC PMVF PMSVC PMFVC Set the ASR (speed loop) integral time 2.	0.100s (0.000s~ 6.000s)	
F03.08 (0x0308) RUN	ASR filter time 2	V/F SVC FVC PMVF PMSVC PMFVC Set the ASR filter time 2.	0.0ms (0.0ms~ 100.0ms)	
F03.09 (0x0309) RUN	ASR switching frequency 2	V/F SVC FVC PMVF PMSVC PMFVC Set the ASR switching frequency 2.	0.00 Hz (0.00 Hz~ maximum frequency)	

Group F03.1x: Current Loop and Torque Limit

Parameter Code (Address)	Name	Description	Default (Range)	Reference Source
F03.10 (0x030A) RUN	Current loop D-axis proportional gain	V/F SVC FVC PMVF PMSVC PMFVC Set the current loop D-axis proportional gain.	1.000 (0.001~4.000)	F03.1x
F03.11 (0x030B) RUN	Current loop D-axis integral gain	V/F SVC FVC PMVF PMSVC PMFVC Set the current loop D-axis integral gain.	1.000 (0.001~4.000)	
F03.12 (0x030C) RUN	Current loop Q-axis proportional gain	V/F SVC FVC PMVF PMSVC PMFVC Set the current loop Q-axis proportional gain.	1.000 (0.001~4.000)	
F03.13 (0x030D) RUN	Current loop Q-axis integral gain	V/F SVC FVC PMVF PMSVC PMFVC Set the current loop Q-axis integral gain.	1.000 (0.001~4.000)	
F03.15 (0x030F) RUN	Torque limit in motoring state	V/F SVC FVC PMVF PMSVC PMFVC Set the torque limit in motoring state.	250.0% (0.0%~ 400.0%)	
F03.16 (0x0310) RUN	Torque limit in power generation state	V/F SVC FVC PMVF PMSVC PMFVC Set the torque limit in power generation state.	250.0% (0.0%~ 400.0%)	
F03.17 (0x0311) RUN	Regenerative torque limit at low speed	V/F SVC FVC PMVF PMSVC PMFVC Set the regenerative torque limit at low speed.	0.0% (0.0%~ 400.0%)	
F03.18 (0x0312) RUN	Frequency amplitude for torque limit action at low speed	V/F SVC FVC PMVF PMSVC PMFVC Set the frequency amplitude for torque limit action at low speed.	6.00Hz (0.00Hz~ 30.00Hz)	

<p>F03.19 (0x0313) RUN</p>	<p>Torque Limit selection</p>	<p>V/F SVC FVC PMVF PMSVC PMFVC LED “0”: Select torque limit channel in motoring state. 0: Keypad digital given 1: Keypad potentiometer (optional external single-line keypad) 2: AI1 3: AI2 4: Reserved 5: PUL 6: RS485 communication (0x3014) 7: Option card LED “00”: Select torque limit channel in power generation state. 0: Keypad digital given 1: Keypad potentiometer (optional external single-line keypad) 2: AI1 3: AI2 4: Reserved 5: PUL 6: RS485 communication (0x3015) 7: Option card LED “000”: 0: C00.06 Display the torque limit value in motoring state 1: C00.06 Display the torque limit value in the power generation state LED “0000”: Reserved</p>	<p>0000 (0000~0177)</p>	
------------------------------------	-------------------------------	---	-----------------------------	--

Group F03.2x: Torque Optimization Control

Parameter Code (Address)	Name	Description	Default (Range)	Reference Source
<p>F03.20 (0x0314) RUN</p>	<p>Low frequency pull-in current of synchronous motor</p>	<p>V/F SVC FVC PMVF PMSVC PMFVC When the SVC of PM motor is activated, the higher the pull-in current, the higher the torque output.</p>	<p>20.0% (0.0%~50.0%)</p>	<p>F03.2x</p>
<p>F03.21 (0x0315) RUN</p>	<p>High frequency pull-in current of synchronous motor</p>	<p>V/F SVC FVC PMVF PMSVC PMFVC When the SVC of PM motor is activated, the higher the pull-in current, the higher the torque output.</p>	<p>10.0% (0.0%~50.0%)</p>	
<p>F03.22 (0x0316) RUN</p>	<p>Pull-in current frequency of synchronous motor</p>	<p>V/F SVC FVC PMVF PMSVC PMFVC The 100.0% corresponds to F01.10 [Maximum Frequency].</p>	<p>10.0% (0.0%~100.0%)</p>	
<p>F03.23 (0x0317) RUN</p>	<p>Slip compensation</p>	<p>V/F SVC FVC PMVF PMSVC PMFVC Set the slip compensation of motor.</p>	<p>100.0% (0.0%~250.0%)</p>	

F03.24 (0x0318) RUN	Initial value of starting torque	V/F SVC FVC PMVF PMSVC PMFVC Set the initial value of starting torque.	0.0% (0.0%~ 250.0%)	
---------------------------	----------------------------------	--	---------------------------	--

Group F03.3x: Flux Optimization

Parameter Code (Address)	Name	Description	Default (Range)	Reference Source
F03.30 (0x031E) RUN	Flux weakening feedforward coefficient	V/F SVC FVC PMVF PMSVC PMFVC Set the feed-forward coefficient of flux weakening.	10.0% (0.0%~500.0%)	F03.3x
F03.31 (0x031F) RUN	Flux weakening control gain	V/F SVC FVC PMVF PMSVC PMFVC Set the gain of flux weakening control.	10.0% (0.0%~500.0%)	
F03.32 (0x0320) RUN	Flux weakening current upper limit	V/F SVC FVC PMVF PMSVC PMFVC Set the upper limit of flux weakening current.	60.0% (0.0%~250.0%)	
F03.33 (0x0321) RUN	Flux weakening voltage coefficient	V/F SVC FVC PMVF PMSVC PMFVC Set the flux weakening voltage coefficient.	97.0% (0.0%~120.0%)	
F03.34 (0x0322) RUN	Shaft output power limit	V/F SVC FVC PMVF PMSVC PMFVC Set the output power limit of motor shaft.	250.0% (0.0%~400.0%)	
F03.35 (0x0323) RUN	over-excitation brake gain	V/F SVC FVC PMVF PMSVC PMFVC Set the over-excitation brake gain.	100.0% (0.0%~500.0%)	
F03.36 (0x0324) RUN	over-excitation brake limit	V/F SVC FVC PMVF PMSVC PMFVC Set the over-excitation brake limit.	100.0% (0.0%~250.0%)	
F03.37 (0x0325) RUN	Energy-saving running	V/F SVC FVC PMVF PMSVC PMFVC 0: OFF 1: ON	0 (0~1)	
F03.38 (0x0326) RUN	Lower excitation limit in energy-saving running	V/F SVC FVC PMVF PMSVC PMFVC Sets the lower excitation limit in energy-saving running.	50.0% (0.0%~80.0%)	
F03.39 (0x0327) RUN	Filter coefficient of energy-saving running	V/F SVC FVC PMVF PMSVC PMFVC Set the filter coefficient of energy-saving running.	0.010s (0.000s~ 6.000s)	

Group F03.4x~F03.5x: Torque Control

Parameter Code (Address)	Name	Description	Default (Range)	Reference Source
F03.40 (0x0328) RUN	Torque control selection	V/F SVC FVC PMVF PMSVC PMFVC 0: Limit torque by speed control 1: Limit speed by torque control	0 (0~1)	F03.4x

F03.41 (0x0329) RUN	Torque command given	V/F SVC FVC PMVF PMSVC PMFVC LED "0": Channel A 0: Digital setting 0: Keypad digital given 1: Keypad potentiometer (optional external single-line keypad) 2: Current/voltage analog AI1 3: Current/voltage analog AI2 4: Reserved 5: PUL 6: RS485 communication 7: Option card 8: Reserved 9: Given by tension calculation LED "00": Channel B LED "000": Mode 0: Channel A 1: Channel B 2: Channel A + Channel B 3: Channel A - Channel B 4: MIN (Channel A, Channel B) 5: MAX (Channel A, Channel B)	0000 (0000~0599)	
F03.42 (0x032A) RUN	Torque given by keypad digital	V/F SVC FVC PMVF PMSVC PMFVC Set the torque given.	0.0% (0.0%~100.0%)	
F03.43 (0x032B) RUN	Torque input lower limit	V/F SVC FVC PMVF PMSVC PMFVC Set the torque input lower limit.	0.00% (0.00%~100.00%)	
F03.44 (0x032C) RUN	Lower limit corresponding setting	V/F SVC FVC PMVF PMSVC PMFVC Set the lower limit corresponding value	0.00% (-250.00%~300.00%)	
F03.45 (0x032D) RUN	Torque input upper limit	V/F SVC FVC PMVF PMSVC PMFVC Set the upper limit of torque input.	100.00% (0.00%~100.00%)	
F03.46 (0x032E) RUN	Upper limit corresponding setting	V/F SVC FVC PMVF PMSVC PMFVC Set the corresponding value of the upper limit.	100.00% (-250.00%~300.00%)	
F03.47 (0x032F) RUN	Torque filter time	V/F SVC FVC PMVF PMSVC PMFVC Set the frequency amplitude for torque limit action at low speed.	0.100s (0.000s~6.000s)	
F03.52 (0x0334) RUN	Output torque upper limit	V/F SVC FVC PMVF PMSVC PMFVC Set the output torque upper limit.	150.0% (0.0%~300.0%)	
F03.53 (0x0335) RUN	Output torque lower limit	V/F SVC FVC PMVF PMSVC PMFVC Set the output torque lower limit.	0.0% (0.0%~300.0%)	

F03.54 (0x0336) RUN	Selection of torque control forward speed limit	V/F SVC FVC PMVF PMSVC PMFVC 0: Function code F03.56 1: Keypad potentiometer (optional external single-line keypad)× F03.56 2: AI1 × F03.56 3: AI2 × F03.56 4: Reserved 5: PUL × F03.56 6: RS485 communication × F03.56 7: Option card × F03.56 8: Reserved	0 (0~8)	
F03.55 (0x0337) RUN	Selection of torque control reverse speed limit	V/F SVC FVC PMVF PMSVC PMFVC 0: Function code F03.57 1: Keypad potentiometer (optional external single-line keypad)× F03.57 2: AI1 × F03.57 3: AI2 × F03.57 4: Reserved 5: PUL × F03.57 6: RS485 communication × F03.57 7: Option card × F03.57 8: Reserved	0 (0~8)	
F03.56 (0x0338) RUN	Torque control maximum forward speed limit	V/F SVC FVC PMVF PMSVC PMFVC Set the torque control maximum forward speed limit.	100.0% (0.0%~100.0%)	
F03.57 (0x0339) RUN	Torque control maximum reverse speed limit	V/F SVC FVC PMVF PMSVC PMFVC Set the torque control maximum reverse speed limit.	100.0% (0.0%~100.0%)	
F03.58 (0x033A) RUN	Given torque gain switching frequency	V/F SVC FVC PMVF PMSVC PMFVC Set the given torque gain switching frequency.	1.00Hz (0.00Hz~50.00Hz)	
F03.59 (0x033B) RUN	Given torque gain setting	V/F SVC FVC PMVF PMSVC PMFVC Set the given torque gain.	100.0% (0.0%~500.0%)	

Group F03.6x: PM High-frequency Injection

Parameter Code (Address)	Name	Description	Default (Range)	Reference Source
F03.60 (0x033C) STOP	High-frequency injection selection	V/F SVC FVC PMVF PMSVC PMFVC Activate in open-loop control of PM motor: select 0 when using a SPM motor; select 0-5 when using an IPM motor. 0: Disabled 1-5: Enabled. The greater the value, the higher the injection frequency.	0 (0~5)	F03.6x
F03.61 (0x033D) RUN	High-frequency injection voltage	V/F SVC FVC PMVF PMSVC PMFVC Injection voltage amplitude (relative to rated voltage). Get after auto-tuning. No need to modify.	10.0% (0.0%~100.0%)	
F03.62 (0x033E) RUN	High-frequency injection cutoff frequency	V/F SVC FVC PMVF PMSVC PMFVC The high-frequency injection action range. Relative to motor rated frequency. The high frequency injection is activated when the motor speed is less than this value.	10.0% (0.0%~20.0%)	

Group F03.7x: Position Compensation

Parameter Code (Address)	Name	Description	Default (Range)	Reference Source
F03.70 (0x0346) RUN	Position compensation control	V/F SVC FVC PMVF PMSVC PMFVC Under speed control, position compensation control is used to achieve zero servo or improve system rigidity.	50.0 (0~100.0)	F03.7x
F03.71 (0x0347) RUN	Compensation gain	V/F SVC FVC PMVF PMSVC PMFVC Set the compensation gain.	0.0 (0.0~250.0)	
F03.72 (0x0348) RUN	Compensation range limiting	V/F SVC FVC PMVF PMSVC PMFVC Set the compensation limiting value.	0.0% (0.0%~100.0%)	
F03.73 (0x0349) RUN	Compensation range	V/F SVC FVC PMVF PMSVC PMFVC Set the compensation range.	0.0% (0.0%~100.0%)	

Group F03.8x: Extension Control

Parameter Code (Address)	Name	Description	Default (Range)	Reference Source
F03.80 (0x0350) RUN	MTPA gain of synchronous motor	V/F SVC FVC PMVF PMSVC PMFVC Set the MTPA gain of synchronous motor.	100.0% (0.0%~400.0%)	F03.8x

F03.81 (0x0351) RUN	MTPA filter time of synchronous motor	V/F SVC FVC PMVF PMSVC PMFVC Set the MTPA filter time of synchronous motor.	1.0ms (0.0ms~ 100.0ms)	
---------------------------	--	--	------------------------------	--

5.8 Group F04: V/F Control

Group F04.0x: V/F Control

Parameter Code (Address)	Name	Description	Default (Range)	Reference Source
F04.00 (0x0400) STOP	Linear V/F curve selection	V/F SVC FVC PMVF PMSVC PMFVC Select the type of V/F curve according to different load characteristics. 0: V/F straight curve; 1-9: 1.1-1.9 power V/F curves, respectively; 10: Square V/F curve; 11: Custom V/F curve;	0 (0~11)	F04.0x
F04.01 (0x0401) RUN	Torque boost	V/F SVC FVC PMVF PMSVC PMFVC 0.0%: Automatic torque boost 0.1% - 30.0%: Manual torque boost	Depending on model (0.0%~30.0%)	
F04.02 (0x0402) RUN	Torque boost cutoff frequency	V/F SVC FVC PMVF PMSVC PMFVC Set the effective range of the torque boost function. The torque boost function will be cut off when the output frequency exceeds this value.	100.0% (0.0%~100.0%)	
F04.03 (0x0403) RUN	Slip compensation gain	V/F SVC FVC PMVF PMSVC PMFVC Set the slip compensation gain.	0.0% (0.0%~200.0%)	
F04.04 (0x0404) RUN	Slip compensation range limiting	V/F SVC FVC PMVF PMSVC PMFVC Set the slip compensation limiting value.	100.0% (0.0%~300.0%)	
F04.05 (0x0405) RUN	Slip compensation filter time	V/F SVC FVC PMVF PMSVC PMFVC To achieve the optimum effect, it is required to correctly enter the parameters on the motor's nameplate and implement parameter tuning when the slip compensation function is activated.	0.200s (0.000s~ 6.000s)	
F04.06 (0x0406) RUN	Oscillation suppression gain	V/F SVC FVC PMVF PMSVC PMFVC Adjust this value to suppress low frequency resonance. Avoid setting it too higher, or it will cause stability problems.	100.0% (0.0%~900.0%)	
F04.07 (0x0407) RUN	Oscillation suppression filter time	V/F SVC FVC PMVF PMSVC PMFVC Set the oscillation suppression filter time.	1.0s (0.0s~100.0s)	
F04.08 (0x0408) STOP	Output voltage percentage	V/F SVC FVC PMVF PMSVC PMFVC Set the output voltage percentage. 100% corresponds to the motor rated voltage.	100.0% (25.0%~ 120.0%)	

Group F04.1x: Custom V/F Curve

Parameter Code (Address)	Name	Description	Default (Range)	Reference Source
F04.10 (0x040A) STOP	Self-setting voltage V1	V/F SVC FVC PMVF PMSVC PMFVC Set the self-setting voltage V1.	3.0% (0.0%~100.0%)	F04.1x
F04.11 (0x040B) STOP	Self-setting frequency F1	V/F SVC FVC PMVF PMSVC PMFVC Set the self-setting frequency F1.	1.00 Hz (0.00 - maximum frequency)	
F04.12 (0x040C) STOP	Self-setting voltage V2	V/F SVC FVC PMVF PMSVC PMFVC Set the self-setting voltage V2.	28.0% (0.0%~100.0%)	
F04.13 (0x040D) STOP	Self-setting frequency F2	V/F SVC FVC PMVF PMSVC PMFVC Set the self-setting frequency F2.	10.00 Hz (0.00 - maximum frequency)	
F04.14 (0x040E) STOP	Self-setting voltage V3	V/F SVC FVC PMVF PMSVC PMFVC Set the self-setting voltage V3.	55.0% (0.0%~100.0%)	
F04.15 (0x040F) STOP	Self-setting frequency F3	V/F SVC FVC PMVF PMSVC PMFVC Set the self-setting frequency F3.	25.00 Hz (0.00 - maximum frequency)	
F04.16 (0x0410) STOP	Self-setting voltage V4	V/F SVC FVC PMVF PMSVC PMFVC Set the self-setting voltage V4.	78.0% (0.0%~100.0%)	
F04.17 (0x0411) STOP	Self-setting frequency F4	V/F SVC FVC PMVF PMSVC PMFVC Set the self-setting frequency F4.	37.50 Hz (0.00 - maximum frequency)	
F04.18 (0x0412) STOP	Self-setting voltage V5	V/F SVC FVC PMVF PMSVC PMFVC Set the self-setting voltage V5.	100.0% (0.0%~100.0%)	
F04.19 (0x0413) STOP	Self-setting frequency F5	V/F SVC FVC PMVF PMSVC PMFVC Set the self-setting frequency F5.	50.00 Hz (0.00 - maximum frequency)	

Group F04.2x: V/F Separation Control

Parameter Code (Address)	Name	Description	Default (Range)	Reference Source
F04.20 (0x0414) RUN	V/F separation voltage given	V/F SVC FVC PMVF PMSVC PMFVC LED “0”: Channel A LED “00”: Channel B 0: Voltage percentage 1: Keypad potentiometer 2: Analog AI1 3: Analog AI2 4: Reserved 5: Terminal pulse PUL 6: PID output 7: RS485 communication 8: Option card 9: Voltage digital LED “000”: Mode 0: Channel A 1: Channel B 2: A + B 3: A-B 4: MIN (A, B) 5: MAX (A, B)	0000 (0000~0599)	F04.2x
F04.21 (0x0415) RUN	V/F separation output voltage percentage setting	V/F SVC FVC PMVF PMSVC PMFVC Set the V/F separation output voltage percentage. 100.0% corresponds to the motor rated voltage.	0.00% (0.00%~110.00%)	
F04.22 (0x0416) RUN	V/F separation voltage acceleration time	V/F SVC FVC PMVF PMSVC PMFVC Set the V/F separation voltage acceleration time.	10.00s (0.00s~100.00s)	
F04.23 (0x0417) RUN	V/F separation voltage deceleration time	V/F SVC FVC PMVF PMSVC PMFVC Set the V/F separation voltage deceleration time.	10.00s (0.00s~100.00s)	
F04.24 (0x0418) RUN	V/F separation stop mode	V/F SVC FVC PMVF PMSVC PMFVC Set the V/F separation stop mode. 0: The acceleration/deceleration of output voltage is independent of the acceleration/deceleration of output frequency. 1: The output frequency drops again after the output voltage drops to 0 V.	0 (0~1)	
F04.25 (0x0419) RUN	V/F separation voltage digital setting	V/F SVC FVC PMVF PMSVC PMFVC Set the V/F separation voltage value.	0.00V (0.00V~600.00V)	

Group F04.3x: V/F Energy-Saving Control

Parameter Code (Address)	Name	Description	Default (Range)	Reference Source
F04.30 (0x041E) STOP	Automatic energy-saving control	V/F SVC FVC PMVF PMSVC PMFVC 0: OFF 1: ON	0 (0~1)	F04.3x
F04.31 (0x041F) STOP	Frequency lower limit of the energy-saving voltage drop	V/F SVC FVC PMVF PMSVC PMFVC Set the frequency lower limit of the energy-saving voltage drop.	15.0Hz (0.0Hz~50.0Hz)	
F04.32 (0x0420) STOP	Voltage lower limit of the energy-saving voltage drop	V/F SVC FVC PMVF PMSVC PMFVC Set the voltage lower limit of the energy-saving voltage drop.	50.0% (20.0%~100.0%)	
F04.33 (0x0421) RUN	Voltage regulation rate of the energy-saving voltage drop	V/F SVC FVC PMVF PMSVC PMFVC Set the voltage regulation rate of the energy-saving voltage drop.	0.010V/ms (0.000V/ms~0.2000V/ms)	
F04.34 (0x0422) RUN	Energy-saving voltage recovery rate	V/F SVC FVC PMVF PMSVC PMFVC Sets the energy-saving voltage recovery rate.	0.200V/ms (0.000V/ms~2.000V/ms)	
F04.35 (0x0423) RUN	Over-excitation coefficient	V/F SVC FVC PMVF PMSVC PMFVC It is activated when the LED "00" of F10.11 is not set as 0. The output voltage increases with the increase of bus voltage at the same output frequency.	64 (0~200)	

5.9 Group F05: Input Terminals

Group F05.0x: Functions of Digital Input Terminals (X1-X10)

Parameter Code (Address)	Name	Description	Default (Range)	Reference Source
F05.00 (0x0500) STOP	Function selection of terminal X1	V/F SVC FVC PMVF PMSVC PMFVC See the functions of terminal X for details.	1 (0~95)	F05.0x
F05.01 (0x0501) STOP	Function selection of terminal X2	V/F SVC FVC PMVF PMSVC PMFVC See the functions of terminal X for details.	2 (0~95)	
F05.02 (0x0502) STOP	Function selection of terminal X3	V/F SVC FVC PMVF PMSVC PMFVC See the functions of terminal X for details.	4 (0~95)	
F05.03 (0x0503) STOP	Function selection of terminal X4	V/F SVC FVC PMVF PMSVC PMFVC See the functions of terminal X for details.	5 (0~95)	
F05.04 (0x0504) STOP	Function selection of terminal X5	V/F SVC FVC PMVF PMSVC PMFVC See the functions of terminal X for details.	6 (0~95)	

F05.05 (0x0505) STOP	Function selection of terminal X6	V/F SVC FVC PMVF PMSVC PMFVC See the functions of terminal X for details.	0 (0~95)	
F05.06 (0x0506) STOP	Function selection of terminal X7	V/F SVC FVC PMVF PMSVC PMFVC See the functions of terminal X for details.	0 (0~95)	
F05.07 (0x0507) STOP	Function selection of terminal X8	V/F SVC FVC PMVF PMSVC PMFVC See the functions of terminal X for details.	0 (0~95)	
F05.08 (0x0508) STOP	Function selection of terminal X9	V/F SVC FVC PMVF PMSVC PMFVC See the functions of terminal X for details.	0 (0~95)	
F05.09 (0x0509) STOP	Function selection of terminal X10	V/F SVC FVC PMVF PMSVC PMFVC See the functions of terminal X for details.	0 (0~95)	

Refer to the table below when setting the functions of F05.0x [Function Selection of Multi-Functional Input Terminals].

Set Point	Function	Set Point	Function
0	No function.	33	Acceleration/deceleration time selection terminal 2.
1	Forward running.	34	Acceleration/deceleration pause
2	Reverse running.	35	Swing frequency on.
3	3-wire running control (Xi).	36	Swing frequency pause
4	Forward jogging.	37	Swing frequency reset.
5	Reverse jogging.	38	Selection of keypad keys and self-test display.
6	Free stop	39	X5 or X10 (extension terminal) frequency measurement.
7	Emergency stop	40	Timer trigger terminal.
8	Fault reset.	41	Timer reset terminal.
9	External fault input.	42	Counter clock input terminal.
10	Frequency UP.	43	Counter reset terminal.
11	Frequency DW.	44	DC brake command.
12	Frequency UP/DW reset.	45	Pre-excitation command terminal.
13	Switch from Channel A to channel B.	46	Reserved.
14	Switch the frequency channel combination to A.	47	Reserved.
15	Switch the frequency channel combination to B.	48	Switch the command channel to keypad.
16	Multi-speed terminal 1.	49	Switch the command channel to terminal.
17	Multi-speed terminal 2.	50	Switch the command channel to communication.
18	Multi-speed terminal 3.	51	Switch the command channel to extension card.
19	Multi-speed terminal 4.	52	Running disable.
20	PID control cancel.	53	Forward disable.
21	PID control pause.	54	Reverse disable.
22	PID characteristic switch	55~59	Reserved.
23	PID parameter switch	60	Speed torque control switch.

24	PID setting switch 1.	61~79	Reserved.
25	PID setting switch 2.	88	Roll diameter reset.
26	PID setting switch 3.	89	Initial roll diameter selection terminal 1.
27	PID feedback switch 1.	90	Initial roll diameter selection terminal 2.
28	PID feedback switch 2.	91	Linear speed selection terminal.
29	PID feedback switch 3.	92	Tension given channel switch
30	Program running (PLC) pause.	93	Reserved.
31	Program running (PLC) restart	94	Winding/unwinding switch
32	Acceleration/deceleration time selection terminal 1.	95	Pre-drive terminal.

Group F05.1x: X1-X5 Detection Delay

Parameter Code (Address)	Name	Description	Default (Range)	Reference Source
F05.10 (0x050A) RUN	X1 activation detection delay	V/F SVC FVC PMVF PMSVC PMFVC The delay time taken by output terminal X1 from deactivation to activation.	0.010s (0.000s~6.000s)	F05.1x
F05.11 (0x050B) RUN	X1 deactivation detection delay	V/F SVC FVC PMVF PMSVC PMFVC The delay time taken by output terminal X1 from activation to deactivation.	0.010s (0.000s~6.000s)	
F05.12 (0x050C) RUN	X2 activation detection delay	V/F SVC FVC PMVF PMSVC PMFVC The delay time taken by output terminal X2 from deactivation to activation.	0.010s (0.000s~6.000s)	
F05.13 (0x050D) RUN	X2 deactivation detection delay	V/F SVC FVC PMVF PMSVC PMFVC The delay time taken by output terminal X2 from activation to deactivation.	0.010s (0.000s~6.000s)	
F05.14 (0x050E) RUN	X3 activation detection delay	V/F SVC FVC PMVF PMSVC PMFVC The delay time taken by output terminal X3 from deactivation to activation.	0.010s (0.000s~6.000s)	
F05.15 (0x050F) RUN	X3 deactivation detection delay	V/F SVC FVC PMVF PMSVC PMFVC The delay time taken by output terminal X3 from activation to deactivation.	0.010s (0.000s~6.000s)	
F05.16 (0x0510) RUN	X4 activation detection delay	V/F SVC FVC PMVF PMSVC PMFVC The delay time taken by output terminal X4 from deactivation to activation.	0.010s (0.000s~6.000s)	
F05.17 (0x0511) RUN	X4 deactivation detection delay	V/F SVC FVC PMVF PMSVC PMFVC The delay time taken by output terminal X4 from activation to deactivation.	0.010s (0.000s~6.000s)	
F05.18 (0x0512) RUN	X5 activation detection delay	V/F SVC FVC PMVF PMSVC PMFVC The delay time taken by output terminal X5 from deactivation to activation.	0.010s (0.000s~6.000s)	
F05.19 (0x0513) RUN	X5 deactivation detection delay	V/F SVC FVC PMVF PMSVC PMFVC The delay time taken by output terminal X5 from activation to deactivation.	0.010s (0.000s~6.000s)	

Group F05.2x: Digital Input Terminal Action Selection

Parameter Code (Address)	Name	Description	Default (Range)	Reference Source
F05.20 (0x0514) STOP	Terminal control running mode	V/F SVC FVC PMVF PMSVC PMFVC 0: 2-wire control 1 1: 2-wire control 2 2: 3-wire control 1 3: 3-wire control 2	0 (0~3)	F05.2x
F05.22 (0x0516) RUN	Terminal X1-X4 characteristic selection	V/F SVC FVC PMVF PMSVC PMFVC 0: Activated when closed 1: Activated when open LED "0": X1 terminal LED "00": X2 terminal LED "000": X3 terminal LED "0000": X4 terminal	0000 (0000~1111)	
F05.23 (0x0517) RUN	Terminal X5-X8 characteristic selection	V/F SVC FVC PMVF PMSVC PMFVC 0: Activated when closed 1: Activated when open LED "0": X5 terminal LED "00": X6 terminal LED "000": X7 terminal LED "0000": X8 terminal	0000 (0000~1111)	
F05.24 (0x0518) RUN	Terminal X9-X10 characteristic selection	V/F SVC FVC PMVF PMSVC PMFVC 0: Activated when closed 1: Activated when open LED "0": X9 terminal LED "00": X10 terminal LED "000": Reserved LED "0000": Reserved	0000 (0000~0011)	
F05.25 (0x0519) STOP	Terminal UP/DW control selection	V/F SVC FVC PMVF PMSVC PMFVC 0: Store frequency during power-off 1: Reset frequency during power-off 2: Adjustable during running; reset during stop	0 (0~2)	
F05.26 (0x051A) RUN	Acceleration/deceleration rate of the terminal UP/DW control frequency	V/F SVC FVC PMVF PMSVC PMFVC Set the acceleration/deceleration rate of the terminal UP/DW control frequency.	0.50Hz/s (0.01Hz/s~50.00Hz/s)	
F05.27 (0x051B) RUN	Deceleration time of emergency stop by terminal	V/F SVC FVC PMVF PMSVC PMFVC Set the deceleration time of emergency stop by terminal.	1.00s (0.01s~650.00s)	

Group F05.3x: PUL Terminal

Parameter Code (Address)	Name	Description	Default (Range)	Reference Source
F05.30 (0x051E) STOP	PUL port signal source	V/F SVC FVC PMVF PMSVC PMFVC 0: X5 (maximum 5.000 kHz) 1: Extension port X10 (maximum 100.00 kHz) 2: X5 (maximum 100.00 kHz)	0 (0~2)	F05.3x
F05.31 (0x051F) RUN	Minimum frequency of PUL input	V/F SVC FVC PMVF PMSVC PMFVC Set the minimum frequency acceptable for PUL. Any frequency signal below this value will be processed as minimum frequency by the inverter. 0.00 kHz - 50.000 kHz (F2.27 is set as 0). 0.00 kHz - 100.00 kHz (F2.27 is set as 1 or 2).	0.000kHz (0.000kHz~500.00kHz)	
F05.32 (0x0520) RUN	PUL minimum frequency corresponding setting	V/F SVC FVC PMVF PMSVC PMFVC Set the percentage of the set value.	0.00% (0.00%~100.00%)	
F05.33 (0x0521) RUN	Maximum frequency of PUL input	V/F SVC FVC PMVF PMSVC PMFVC Set the maximum frequency acceptable for PUL. Any frequency signal above this value will be processed as maximum frequency by the inverter. 0.00 kHz - 50.000 kHz (F2.27 is set as 0). 0.00 kHz - 100.00 kHz (F2.27 is set as 1 or 2).	5.000kHz (0.000kHz~500.00kHz)	
F05.34 (0x0522) RUN	PUL maximum frequency corresponding setting	V/F SVC FVC PMVF PMSVC PMFVC Set the percentage of the set value.	100.00% (0.00%~100.00%)	
F05.35 (0x0523) RUN	PUL filter time	V/F SVC FVC PMVF PMSVC PMFVC Define the level of filtering input pulse signals to eliminate interference signals.	0.100s (0.000s~9.000s)	
F05.36 (0x0524) RUN	PUL cutoff frequency	V/F SVC FVC PMVF PMSVC PMFVC Any frequency lower than this value will not be recognized and will be processed as 0 Hz by the inverter.	0.010kHz (0.000kHz~1.000kHz)	

Group F05.4x: Analog Input (AI) Type Processing

Parameter Code (Address)	Name	Description	Default (Range)	Reference Source
F05.41 (0x0529) RUN	AI1 input signal type	V/F SVC FVC PMVF PMSVC PMFVC 0: Voltage 0 V - 10.00 V 1: Current 0 mA - 20.00 mA	0 (0~1)	F05.4x

F05.42 (0x052A) RUN	AI2 input signal type	V/F SVC FVC PMVF PMSVC PMFVC 0: Voltage 0 V - 10.00 V 1: Current 0 mA - 20.00 mA	0 (0~1)	
F05.43 (0x052B) RUN	Analog value input curve selection	V/F SVC FVC PMVF PMSVC PMFVC 0: Straight line (default) 1: Curve 1 2: Curve 2 LED "0": AI1 LED "00": AI2 (selecting voltage or current input with jumpers) LED "000": Reserved LED "0000": Reserved	0000 (0000~0022)	

Group F05.5x: Analog Input (AI) Linear Processing

Parameter Code (Address)	Name	Description	Default (Range)	Reference Source
F05.50 (0x0532) RUN	AI1 lower limit	V/F SVC FVC PMVF PMSVC PMFVC Define the signal received by the terminal. Any voltage signal below this lower limit is processed as lower limit.	0.0% (0.0%~100.0%)	F05.5x
F05.51 (0x0533) RUN	AI1 lower limit corresponding setting	V/F SVC FVC PMVF PMSVC PMFVC Set the percentage of the set value.	0.00% (-100.00%~ 100.00%)	
F05.52 (0x0534) RUN	AI1 upper limit	V/F SVC FVC PMVF PMSVC PMFVC Define the signal received by the terminal. Any voltage signal above this upper limit is processed as upper limit.	100.0% (0.0%~100.0%)	
F05.53 (0x0535) RUN	AI1 upper limit corresponding setting	V/F SVC FVC PMVF PMSVC PMFVC Set the percentage of the set value.	100.00% (-100.00%~ 100.00%)	
F05.54 (0x0536) RUN	AI1 filter time	V/F SVC FVC PMVF PMSVC PMFVC Define the level of filtering analog signals to eliminate interference signals.	0.100s (0.000s~ 6.000s)	
F05.55 (0x0537) RUN	AI2 lower limit	V/F SVC FVC PMVF PMSVC PMFVC Define the signal received by the terminal. Any voltage signal below this lower limit is processed as lower limit.	0.0% (0.0%~100.0%)	
F05.56 (0x0538) RUN	AI2 lower limit corresponding setting	V/F SVC FVC PMVF PMSVC PMFVC Set the percentage of the set value.	0.00% (-100.00%~ 100.00%)	
F05.57 (0x0539) RUN	AI2 upper limit	V/F SVC FVC PMVF PMSVC PMFVC Define the signal received by the terminal. Any voltage signal above this upper limit is processed as upper limit.	100.0% (0.0%~100.0%)	

F05.58 (0x053A) RUN	AI2 upper limit corresponding setting	V/F SVC FVC PMVF PMSVC PMFVC Set the percentage of the set value.	100.00% (-100.00%~ 100.00%)	
F05.59 (0x053B) RUN	AI2 filter time	V/F SVC FVC PMVF PMSVC PMFVC Define the level of filtering analog signals to eliminate interference signals.	0.100s (0.000s~ 6.000s)	

Group F05.6x: AI Curve 1 Processing

Parameter Code (Address)	Name	Description	Default (Range)	Reference Source
F05.60 (0x053C) RUN	Curve 1 lower limit	V/F SVC FVC PMVF PMSVC PMFVC Set the lower limit value of curve 1.	0.0% (0.0%~100.0%)	F05.6x
F05.61 (0x053D) RUN	Curve 1 lower limit corresponding setting	V/F SVC FVC PMVF PMSVC PMFVC Set the percentage of the corresponding setting.	0.00% (-100.00%~ 100.00%)	
F05.62 (0x053E) RUN	Input voltage of inflexion point 1 of curve 1	V/F SVC FVC PMVF PMSVC PMFVC Set the input voltage of inflection point 1 of curve 1.	30.0% (0.0%~100.0%)	
F05.63 (0x053F) RUN	Correspondin g setting of inflexion point 1 of curve 1	V/F SVC FVC PMVF PMSVC PMFVC Set the percentage of the corresponding setting.	30.00% (-100.00%~ 100.00%)	
F05.64 (0x0540) RUN	Input voltage of inflexion point 2 of curve 1	V/F SVC FVC PMVF PMSVC PMFVC Set the input voltage of inflection point 2 of curve 1.	60.0% (0.0%~100.0%)	
F05.65 (0x0541) RUN	Correspondin g setting of inflexion Point 2 of Curve 1	V/F SVC FVC PMVF PMSVC PMFVC Set the percentage of the corresponding setting.	60.00% (-100.00%~ 100.00%)	
F05.66 (0x0542) RUN	Curve 1 upper limit	V/F SVC FVC PMVF PMSVC PMFVC Set the upper limit value of curve 1.	100.0% (0.0%~100.0%)	
F05.67 (0x0543) RUN	Curve 1 upper limit corresponding setting	V/F SVC FVC PMVF PMSVC PMFVC Set the percentage of the corresponding setting.	100.00% (-100.00%~ 100.00%)	

Group F05.7x: AI Curve 2 Processing

Parameter Code (Address)	Name	Description	Default (Range)	Reference Source
F05.70 (0x0546) RUN	Curve 2 lower limit	V/F SVC FVC PMVF PMSVC PMFVC Set the lower limit of curve 2.	0.0% (0.0%~100.0%)	F05.7x

F05.71 (0x0547) RUN	Curve 2 lower limit correspondin g setting	V/F SVC FVC PMVF PMSVC PMFVC Set the percentage of the corresponding setting.	0.00% (-100.00%~ 100.00%)	
F05.72 (0x0548) RUN	Input voltage of inflexion point 1 of curve 2	V/F SVC FVC PMVF PMSVC PMFVC Set the input voltage of inflexion point 1 of curve 2.	30.0% (0.0%~100.0%)	
F05.73 (0x0549) RUN	Correspondin g setting of inflexion point 1 of curve 2	V/F SVC FVC PMVF PMSVC PMFVC Set the percentage of the corresponding setting.	30.00% (-100.00%~ 100.00%)	
F05.74 (0x054A) RUN	Input voltage of inflexion point 2 of curve 2	V/F SVC FVC PMVF PMSVC PMFVC Set the input voltage of inflexion point 2 of curve 2.	60.0% (0.0%~100.0%)	
F05.75 (0x054B) RUN	Correspondin g setting of inflexion point 2 of curve 2	V/F SVC FVC PMVF PMSVC PMFVC Set the percentage of the corresponding setting.	60.00% (-100.00%~ 100.00%)	
F05.76 (0x054C) RUN	Curve 2 upper limit	V/F SVC FVC PMVF PMSVC PMFVC Set the upper limit value of curve 2.	100.0% (0.0%~100.0%)	
F05.77 (0x054D) RUN	Curve 2 upper limit correspondin g setting	V/F SVC FVC PMVF PMSVC PMFVC Set the percentage of the corresponding setting.	100.00% (-100.00%~ 100.00%)	

Group F05.8x: AI as Digital Input Terminals

Parameter Code (Address)	Name	Description	Default (Range)	Reference Source
F05.80 (0x0550) RUN	Characteristi c selection of AI as digital input terminal	V/F SVC FVC PMVF PMSVC PMFVC 0: Active low. 1: Active high. LED "0": AI1 LED "00": AI2 LED "000": Reserved LED "0000": Reserved	0000 (0000~0011)	F05.8x
F05.81 (0x0551) STOP	Function selection of AI1 terminal (as X)	V/F SVC FVC PMVF PMSVC PMFVC See the functions of terminal X.	0 (0~95)	
F05.82 (0x0552) RUN	High level setting of AI1	V/F SVC FVC PMVF PMSVC PMFVC The input is high level if the input is higher than the high level setting.	70.00% (0.00%~ 100.00%)	
F05.83 (0x0553) RUN	Low level setting of AI1	V/F SVC FVC PMVF PMSVC PMFVC The input is low level if the input is lower than the low level setting.	30.00% (0.00%~ 100.00%)	

F05.84 (0x0554) STOP	Function selection of AI2 terminal (as X)	V/F SVC FVC PMVF PMSVC PMFVC See the functions of terminal X.	0 (0~95)	
F05.85 (0x0555) RUN	High level setting of AI2	V/F SVC FVC PMVF PMSVC PMFVC The input is high level if the input is higher than the high level setting.	70.00% (0.00%~100.00%)	
F05.86 (0x0556) RUN	Low level setting of AI2	V/F SVC FVC PMVF PMSVC PMFVC The input is low level if the input is lower than the low level setting.	30.00% (0.00%~100.00%)	

5.10 Group F06: Output Terminals

Group F06.0x: AO Output (Analog, Frequency)

Parameter Code (Address)	Name	Description	Default (Range)	Reference Source
F06.00 (0x0600) RUN	AO output mode selection	V/F SVC FVC PMVF PMSVC PMFVC 0: 0 V - 10 V 1: 4.00 mA ~ 20.00 mA 2: 0.00 mA ~ 20.00 mA 3: FM frequency pulse output	0 (0~3)	F06.0x
F06.01 (0x0601) RUN	AO output selection	V/F SVC FVC PMVF PMSVC PMFVC 0: Given frequency 1: Output frequency 2: Output current 3: Input voltage 4: Output voltage 5: Mechanical speed 6: Given torque 7: Output torque 8: PID given value 9: PID feedback value 10: Output power 11: Bus voltage 12: AI1 input value 13: AI2 input value 14: Reserved 15: PUL input value 16: Module temperature 1 17: Module temperature 2 18: 485 communication given 19: Virtual terminal vY1	0 (0~19)	
F06.02 (0x0602) RUN	AO output gain	V/F SVC FVC PMVF PMSVC PMFVC Adjust the value of terminal analog output.	100.0% (0.0%~300.0%)	
F06.03 (0x0603) RUN	AO output bias	V/F SVC FVC PMVF PMSVC PMFVC Set the AO output bias. Adjust the zero point of terminal output.	0.0% (-10.0%~10.0%)	

F06.04 (0x0604) RUN	AO output filtering	V/F SVC FVC PMVF PMSVC PMFVC Define the level of filtering analog signals to eliminate interference signals.	0.010s (0.000s~ 6.000s)	
F06.05 (0x0605) RUN	AO as lower limit of FM frequency output	V/F SVC FVC PMVF PMSVC PMFVC Set the lower limit of output signal.	0.20kHz (0.00kHz~ 100.00kHz)	
F06.06 (0x0606) RUN	AO as upper limit of FM frequency output	V/F SVC FVC PMVF PMSVC PMFVC Set the upper limit of FM frequency output.	50.00kHz (0.00kHz~ 100.00kHz)	

Group F06.1x: Extended AO Output

Parameter Code (Address)	Name	Description	Default (Range)	Reference Source
F06.10 (0x060A) RUN	Extended AO output mode selection	V/F SVC FVC PMVF PMSVC PMFVC 0: 0 V - 10 V 1: 4.00 mA ~ 20.00 mA 2: 0.00 mA ~ 20.00 mA 3: Reserved	0 (0~3)	F06.1x
F06.11 (0x060B) RUN	Extended AO output value selection	V/F SVC FVC PMVF PMSVC PMFVC The selection of extended AO output value. The same as the selection in F06.01.	1 (0~19)	
F06.12 (0x060C) RUN	Extended AO output gain	V/F SVC FVC PMVF PMSVC PMFVC Adjust the value of terminal output.	100.0% (0.0%~300.0%)	
F06.13 (0x060D) RUN	Extended AO analog output bias	V/F SVC FVC PMVF PMSVC PMFVC Adjust the zero point of terminal output.	0.0% (-10.0%~ 10.0%)	
F06.14 (0x060E) RUN	Extended AO output filtering	V/F SVC FVC PMVF PMSVC PMFVC Define the level of filtering analog signals to eliminate interference signals.	0.010s (0.000s~ 6.000s)	

Group F06.2x~F06.3x: Digital and Relay Output

Parameter Code (Address)	Name	Description	Default (Range)	Reference Source
F06.20 (0x0614) RUN	Output terminal polarity selection	V/F SVC FVC PMVF PMSVC PMFVC 0: Positive polarity 1: Negative polarity LED "0": Y terminal LED "00": Relay output terminal 1 LED "000": Extended terminal Y LED "0000": Extended relay output terminal	0000 (0000~1111)	F06.2x
F06.21 (0x0615) RUN	Output terminal Y	V/F SVC FVC PMVF PMSVC PMFVC See the functions of terminal Y.	1 (0~63)	
F06.22 (0x0616) RUN	Relay 1 output (TA-TB-TC)	V/F SVC FVC PMVF PMSVC PMFVC See the functions of terminal Y.	4 (0~63)	
F06.23 (0x0617) RUN	Extended output terminal Y1	V/F SVC FVC PMVF PMSVC PMFVC See the functions of terminal Y.	0 (0~63)	
F06.24 (0x0618) RUN	Extended relay 2 output (TA-TB-TC)	V/F SVC FVC PMVF PMSVC PMFVC See the functions of terminal Y.	0 (0~31)	
F06.25 (0x0619) RUN	Delay when Y outputs ON	V/F SVC FVC PMVF PMSVC PMFVC Set the ON delay for Y output.	0.010s (0.000s~ 60.000s)	

F06.26 (0x061A) RUN	Delay when relay 1 outputs ON	V/F SVC FVC PMVF PMSVC PMFVC Set the ON delay for relay 1 output.	0.010s (0.000s~ 60.000s)	
F06.27 (0x061B) RUN	Delay when extended Y outputs ON	V/F SVC FVC PMVF PMSVC PMFVC Set the ON delay for Extended Y output	0.010s (0.000s~ 60.000s)	
F06.28 (0x061C) RUN	Delay when extended relay 2 outputs ON	V/F SVC FVC PMVF PMSVC PMFVC Set the ON delay for Extended relay 2 output	0.010s (0.000s~ 60.000s)	
F06.29 (0x061D) RUN	Delay when Y outputs OFF	V/F SVC FVC PMVF PMSVC PMFVC Set the OFF delay for Y output	0.010s (0.000s~ 60.000s)	
F06.30 (0x061E) RUN	Delay when relay 1 outputs OFF	V/F SVC FVC PMVF PMSVC PMFVC Set the OFF delay for relay 1 output.	0.010s (0.000s~ 60.000s)	
F06.31 (0x061F) RUN	Delay when extended Y outputs OFF	V/F SVC FVC PMVF PMSVC PMFVC Set the OFF delay for extended Y1 output	0.010s (0.000s~ 60.000s)	
F06.32 (0x0620) RUN	Delay when extended relay 2 outputs OFF	V/F SVC FVC PMVF PMSVC PMFVC Set the OFF delay for extended relay 2 output	0.010s (0.000s~ 60.000s)	

Group F06.4x: Frequency Detection

Parameter Code (Address)	Name	Description	Default (Range)	Reference Source
F06.40 (0x0628) RUN	Frequency detection value 1	V/F SVC FVC PMVF PMSVC PMFVC Set frequency detection value 1.	2.00 Hz (0.00 Hz - maximum frequency)	F06.4x
F06.41 (0x0629) RUN	Frequency detection range 1	V/F SVC FVC PMVF PMSVC PMFVC Set frequency detection range 1.	1.00 Hz (0.00 Hz - maximum frequency)	
F06.42 (0x062A) RUN	Frequency detection value 2	V/F SVC FVC PMVF PMSVC PMFVC Set frequency detection value 2.	2.00 Hz (0.00 Hz - maximum frequency)	
F06.43 (0x062B) RUN	Frequency detection range 2	V/F SVC FVC PMVF PMSVC PMFVC Set frequency detection range 2.	1.00 Hz (0.00 Hz - maximum frequency)	
F06.44 (0x062C) RUN	Detection range for the given frequency arrival	V/F SVC FVC PMVF PMSVC PMFVC Set the detection range for the given frequency arrival.	2.00 Hz (0.00 Hz - maximum frequency)	

Group F06.5x: Monitoring Parameter Comparator Output

Parameter Code (Address)	Name	Description	Default (Range)	Reference Source
--------------------------	------	-------------	-----------------	------------------

F06.50 (0x0632) RUN	Comparator 1 monitor selection	V/F SVC FVC PMVF PMSVC PMFVC LED “0” and LED “00”: Set yy in monitoring parameter number Cxx.yy 00~63 LED “000” and LED “0000”s: Set xx in monitoring parameter number Cxx.yy 00~07	0001 (0000~0763)	F06.5x
F06.51 (0x0633) RUN	Comparator 1 upper limit	V/F SVC FVC PMVF PMSVC PMFVC Set the upper limit of comparator 1.	(Determined by F06.50)	
F06.52 (0x0634) RUN	Comparator 1 lower limit	V/F SVC FVC PMVF PMSVC PMFVC Set the lower limit of comparator 1.	(Determined by F06.50)	
F06.53 (0x0635) RUN	Comparator 1 offset	V/F SVC FVC PMVF PMSVC PMFVC Set the offset value of comparator 1.	(Determined by F06.50)	
F06.54 (0x0636) RUN	Operation selection while transmitting CP1	V/F SVC FVC PMVF PMSVC PMFVC 0: Continue running (digital terminal output only) 1: Alarm and free stop 2: Warning and keep running 3: Forced stop	0 (0~3)	
F06.55 (0x0637) RUN	Comparator 2 monitor selection	V/F SVC FVC PMVF PMSVC PMFVC LED “0” and LED “00”s: Set yy in monitoring parameter number Cxx.yy 00~63 LED “000” and LED “0000”s: Set xx in monitoring parameter number Cxx.yy 00~07	0002 (0000~0763)	
F06.56 (0x0638) RUN	Comparator 2 upper limit	V/F SVC FVC PMVF PMSVC PMFVC Set the lower limit of comparator 2.	(Depending on F06.55)	
F06.57 (0x0639) RUN	Comparator 2 lower limit	V/F SVC FVC PMVF PMSVC PMFVC Set the upper limit of comparator 2.	(Depending on F06.55)	
F06.58 (0x063A) RUN	Comparator 2 offset	V/F SVC FVC PMVF PMSVC PMFVC Set the offset value of comparator 2.	(Depending on F06.55)	
F06.59 (0x063B) RUN	Operation selection while transmitting CP2	V/F SVC FVC PMVF PMSVC PMFVC 0: Continue running (digital terminal output only) 1: Alarm and free stop 2: Warning and keep running 3: Forced stop	0 (0~3)	

Group F06.6x~Group F06.7x: Virtual Input and Output Terminals

Parameter Code (Address)	Name	Description	Default (Range)	Reference Source
F06.60 (0x063C) STOP	Function selection of virtual terminal vX1	V/F SVC FVC PMVF PMSVC PMFVC See the functions of terminal X.	0 (0~95)	F06.6x
F06.61 (0x063D) STOP	Function selection of virtual terminal vX2	V/F SVC FVC PMVF PMSVC PMFVC See the functions of terminal X.	0 (0~95)	
F06.62 (0x063E) STOP	Function selection of virtual terminal vX3	V/F SVC FVC PMVF PMSVC PMFVC See the functions of terminal X.	0 (0~95)	
F06.63 (0x063F) STOP	Function selection of virtual terminal vX4	V/F SVC FVC PMVF PMSVC PMFVC See the functions of terminal X.	0 (0~95)	
F06.64 (0x0640) RUN	Activation state source of terminal vX	V/F SVC FVC PMVF PMSVC PMFVC 0: Internally connected to virtual vYn 1: Connected to physical terminal Xn 2: Whether the function code setting is activated LED "0": Virtual vX1 LED "00": Virtual vX2 LED "000": Virtual vX3 LED "0000": Virtual vX4	0000 (0000~2222)	
F06.65 (0x0641) RUN	Activation state of function code setting for virtual terminal vX	V/F SVC FVC PMVF PMSVC PMFVC 0: Deactivated; 1: Activated LED "0": Virtual vX1 LED "00": Virtual vX2 LED "000": Virtual vX3 LED "0000": Virtual vX4	0000 (0000~1111)	
F06.66 (0x0642) RUN	Virtual vY1 output selection	V/F SVC FVC PMVF PMSVC PMFVC See the functions of terminal Y.	0 (0~63)	
F06.67 (0x0643) RUN	Virtual vY2 output selection	V/F SVC FVC PMVF PMSVC PMFVC See the functions of terminal Y.	0 (0~63)	
F06.68 (0x0644) RUN	Virtual vY3 output selection	V/F SVC FVC PMVF PMSVC PMFVC See the functions of terminal Y.	0 (0~63)	
F06.69 (0x0645) RUN	Virtual vY4 output selection	V/F SVC FVC PMVF PMSVC PMFVC See the functions of terminal Y.	0 (0~63)	
F06.70 (0x0646) RUN	Delay when vY1 outputs ON	V/F SVC FVC PMVF PMSVC PMFVC Set the ON delay for vY1 output.	0.010s (0.000s~60.000s)	

F06.71 (0x0647) RUN	Delay when vY2 outputs ON	V/F SVC FVC PMVF PMSVC PMFVC Set the ON delay for vY2 output.	0.010s (0.000s~ 60.000s)	
F06.72 (0x0648) RUN	Delay when vY3 outputs ON	V/F SVC FVC PMVF PMSVC PMFVC Set the ON delay for vY3 output.	0.010s (0.000s~ 60.000s)	
F06.73 (0x0649) RUN	Delay when vY4 outputs ON	V/F SVC FVC PMVF PMSVC PMFVC Set the ON delay for vY4 output.	0.010s (0.000s~ 60.000s)	
F06.74 (0x064A) RUN	Delay when vY1 outputs OFF	V/F SVC FVC PMVF PMSVC PMFVC Set the OFF delay for vY1 output.	0.010s (0.000s~ 60.000s)	
F06.75 (0x064B) RUN	Delay when vY2 outputs OFF	V/F SVC FVC PMVF PMSVC PMFVC Set the OFF delay for vY2 output.	0.010s (0.000s~ 60.000s)	
F06.76 (0x064C) RUN	Delay when vY3 outputs OFF	V/F SVC FVC PMVF PMSVC PMFVC Set the OFF delay for vY3 output.	0.010s (0.000s~ 60.000s)	
F06.77 (0x064D) RUN	Delay when vY4 outputs OFF	V/F SVC FVC PMVF PMSVC PMFVC Set the OFF delay for vY4 output.	0.010s (0.000s~ 60.000s)	

5.11 Group F07: Running Control

Group F07.0x: Start Control

Parameter Code (Address)	Name	Description	Default (Range)	Reference Source
F07.00 (0x0700) STOP	Start mode	V/F SVC FVC PMVF PMSVC PMFVC 0: Start from start frequency 1: Apply DC brake first and then start from the Start frequency 2: Start after speed tracking and direction judgment	0 (0~2)	F07.0x
F07.01 (0x0701) STOP	Start pre-excitation time	V/F SVC FVC PMVF PMSVC PMFVC The vector control of asynchronous motor supports pre-excitation, which is not supported in other cases; When it is set as 0, the start pre-excitation time is determined by the motor parameters; When it is set as a non-0 value, the start pre-excitation time is the setting value.	0.00s (0.00s~60.00s)	
F07.02 (0x0702) STOP	Start frequency	V/F SVC FVC PMVF PMSVC PMFVC The inverter does not start and stays in standby state when the given frequency is lower than this value.	0.50 Hz (0.00 - upper frequency limit set by numbers)	

F07.03 (0x0703) STOP	Start protection selection	V/F SVC FVC PMVF PMSVC PMFVC 0: OFF 1: ON LED “0”: Terminal start protection in case of abnormal exit LED “00”: Jogging terminal start protection in case of abnormal exit LED “000”: Terminal start protection when the command channel is switched to terminal LED “0000”: Reserved Note: The terminal start protection is enabled by default when the free stop, emergency stop or forced stop command is activated.	0111 (0000~0111)	
F07.05 (0x0705) STOP	Rotation direction selection	V/F SVC FVC PMVF PMSVC PMFVC LED “0”: Reverse running direction 0: Direction unchanged 1: Reverse direction LED “00”: Running direction disabled 0: Both forward and reserve commands are allowed 1: Only forward command is allowed 2: Only reverse command is allowed LED “000”: Command direction is controlled by frequency 0: Frequency-based direction control is deactivated 1: Frequency-based direction control is activated LED “0000”: Reserved Note: This value will not be reset during initialization, and the LED ”0” value will not be changed after parameter download	0000 (0000~1121)	
F07.06 (0x0706) STOP	Selection of restart action after power failure	V/F SVC FVC PMVF PMSVC PMFVC 0: Deactivated 1: Speed tracking Start 2: Start according to the Start mode	0 (0~2)	
F07.07 (0x0707) STOP	Waiting time for restart after power failure	V/F SVC FVC PMVF PMSVC PMFVC Set the waiting time for restart after power failure.	0.50s (0.00s~60.00s)	

Group F07.1x: Stop and Zero-Frequency Control

Parameter Code (Address)	Name	Description	Default (Range)	Reference Source
F07.10 (0x070A) RUN	Stop mode	V/F SVC FVC PMVF PMSVC PMFVC 0: Deceleration stop 1: Free stop (All stop commands are processed as free stop)	0 (0~1)	F07.1x

F07.11 (0x070B) RUN	Stop detection frequency	V/F SVC FVC PMVF PMSVC PMFVC When decelerating to stop, the inverter will stop if the output frequency is lower than this value.	0.50 Hz (0.00 - upper frequency limit digital setting)	
F07.12 (0x070C) STOP	Minimum time between stop and restart	V/F SVC FVC PMVF PMSVC PMFVC The minimum interval between stop and restart.	0.000s (0.000s~ 60.000s)	
F07.15 (0x070F) RUN	Selection of action below lower limit frequency	V/F SVC FVC PMVF PMSVC PMFVC 0: Run according to the frequency command 1: Free stop and enter standby state 2: Run at the lower limit frequency 3: Run at zero speed	2 (0~3)	
F07.16 (0x0710) RUN	Zero-speed torque retention coefficient	SVC FVC PMVF PMSVC PMFVC Set the zero-speed torque current. 100.0% corresponds to the motor rated current, and the upper limit of the zero-speed torque current is the rated current of the inverter.	60.0% (0.0%~ 150.0%)	
F07.17 (0x0711) RUN	Zero-speed torque retention time	SVC FVC PMVF PMSVC PMFVC Set the zero-speed torque retention time.	0.0s (0.0s~6000.0s)	
F07.18 (0x0712) STOP	Forward and reverse rotation dead time	V/F SVC FVC PMVF PMSVC PMFVC Set the zero-frequency retention time in the case of switching between forward and reverse rotations.	0.0s (0.0s~120.0s)	

Group F07.2x: DC Braking and Speed Tracking

Parameter Code (Address)	Name	Description	Default (Range)	Reference Source
F07.20 (0x0714) STOP	Brake current before start	V/F SVC FVC PMVF PMSVC PMFVC 100.0% corresponds to the motor rated current, and the upper limit of brake current is the rated current of the inverter.	60.0% (0.0%~ 150.0%)	F07.2x
F07.21 (0x0715) STOP	Brake time before start	V/F SVC FVC PMVF PMSVC PMFVC Set the brake time before start.	0.0s (0.0s~60.0s)	
F07.22 (0x0716) STOP	DC braking start frequency	V/F SVC FVC PMVF PMSVC PMFVC Set the DC braking start frequency.	1.00Hz (0.00Hz~ 50.00Hz)	
F07.23 (0x0717) STOP	DC brake current	V/F SVC FVC PMVF PMSVC PMFVC 100.0% corresponds to the motor rated current, and the upper limit of brake current is the rated current of the inverter.	60.0% (0.0%~ 150.0%)	
F07.24 (0x0718) STOP	DC braking time during stop	V/F SVC FVC PMVF PMSVC PMFVC DC braking time during stop.	0.0s (0.0s~60.0s)	

F07.25 (0x0719) STOP	Speed tracking mode	V/F SVC FVC PMVF PMSVC PMFVC LED “0”: Search mode 0: Search from maximum frequency 1: Search from stop frequency LED “00”: Reverse search 0: OFF 1: ON LED “000”: Reserved LED “0000”: Reserved	0000 (0000~0111)	
F07.26 (0x071A) STOP	Speed tracking time	V/F SVC FVC PMVF PMSVC PMFVC Speed tracking time.	0.50s (0.00s~60.00s)	
F07.27 (0x071B) STOP	Speed tracking stop delay	V/F SVC FVC PMVF PMSVC PMFVC Speed tracking stop delay.	1.00s (0.00s~60.00s)	
F07.28 (0x071C) STOP	Speed tracking current	V/F SVC FVC PMVF PMSVC PMFVC Set the speed tracking current.	120.0% (0.0%~400.0%)	

Group F07.3x: Jogging

Parameter Code (Address)	Name	Description	Default (Range)	Reference Source
F07.30 (0x071E) RUN	Jogging frequency setting	V/F SVC FVC PMVF PMSVC PMFVC Set the jogging frequency.	5.00 Hz (0.00 Hz - maximum frequency)	F07.3x
F07.31 (0x071F) RUN	Jogging acceleration time	V/F SVC FVC PMVF PMSVC PMFVC Set the jogging acceleration time.	10.00s (0.00s~650.00s)	
F07.32 (0x0720) RUN	Jogging deceleration time	V/F SVC FVC PMVF PMSVC PMFVC Set the jogging deceleration time.	10.00s (0.00s~650.00s)	
F07.33 (0x0721) RUN	Jogging S-curve selection	V/F SVC FVC PMVF PMSVC PMFVC 0: Deactivated 1: Activated	1 (0~1)	
F07.34 (0x0722) RUN	Jogging stop mode selection	V/F SVC FVC PMVF PMSVC PMFVC 0: The same as the stop mode set by F7.10. 1: Deceleration stop only.	0 (0~1)	

Group F07.4x: Start and Stop Frequency Retention and Frequency Hopping

Parameter Code (Address)	Name	Description	Default (Range)	Reference Source
F07.40 (0x0728) STOP	Start retention frequency	V/F SVC FVC PMVF PMSVC PMFVC The Start retention frequency is higher than the Start frequency and lower than the upper frequency limit set by numbers.	0.50 Hz (0.00 Hz - upper frequency limit set by numbers)	F07.4x

F07.41 (0x0729) STOP	Start frequency retention time	V/F SVC FVC PMVF PMSVC PMFVC The set point should be greater than the Start frequency, and if not, the Start frequency will be used.	0.00s (0.00s~60.00s)	
F07.42 (0x072A) STOP	Stop retention frequency	V/F SVC FVC PMVF PMSVC PMFVC Set the retention frequency during stop.	0.50 Hz (0.00 - upper frequency limit set by numbers)	
F07.43 (0x072B) STOP	Stop frequency retention time	V/F SVC FVC PMVF PMSVC PMFVC Set the frequency retention time during stop.	0.00s (0.00s~60.00s)	
F07.44 (0x072C) RUN	Jumping frequency 1	V/F SVC FVC PMVF PMSVC PMFVC Set the jumping frequency 1.	0.00 Hz (0.00 - maximum frequency)	
F07.45 (0x072D) RUN	Jumping frequency amplitude 1	V/F SVC FVC PMVF PMSVC PMFVC Set the jumping frequency amplitude 1.	0.00 Hz (0.00 - maximum frequency)	
F07.46 (0x072E) RUN	Jumping frequency 2	V/F SVC FVC PMVF PMSVC PMFVC Set the jumping frequency 2.	0.00 Hz (0.00 - maximum frequency)	
F07.47 (0x072F) RUN	Jumping frequency amplitude 2	V/F SVC FVC PMVF PMSVC PMFVC Set the jumping frequency amplitude 1.	0.00 Hz (0.00 - maximum frequency)	

5.12 Group F08: Auxiliary Control

Group F08.0x: Counting and Timing

Parameter Code (Address)	Name	Description	Default (Range)	Reference Source
F08.00 (0x0800) RUN	Counter input source	V/F SVC FVC PMVF PMSVC PMFVC 0: Normal terminal X 1: Input terminal PUL 2: PG card feedback counting	0 (0~2)	F08.0x
F08.01 (0x0801) RUN	Count input frequency division	V/F SVC FVC PMVF PMSVC PMFVC Set the count input frequency division.	0 (0~6000)	
F08.02 (0x0802) RUN	Counter maximum value	V/F SVC FVC PMVF PMSVC PMFVC Set the counter maximum value.	1000 (0~65000)	
F08.03 (0x0803) RUN	Counter setting value	V/F SVC FVC PMVF PMSVC PMFVC Set the counter setting value.	500 (0~65000)	
F08.04 (0x0804) RUN	Number of pulses per meter	V/F SVC FVC PMVF PMSVC PMFVC The counting value per meter.	10.0 (0.1~6553.5)	

F08.05 (0x0805) STOP	Set length	V/F SVC FVC PMVF PMSVC PMFVC Add a length reaching output, and a terminal length reset.	1000 (0m~65535m)	
F08.06 (0x0806) STOP	Actual length	V/F SVC FVC PMVF PMSVC PMFVC Reset during power-off. Chooses whether to store during power-off.	0 (0m~65535m)	
F08.07 (0x0807) STOP	Timer time unit	V/F SVC FVC PMVF PMSVC PMFVC 0: Second (s) 1: Minute (min) 2: Hour (h)	0 (0~2)	
F08.08 (0x0808) STOP	Timer setting value	V/F SVC FVC PMVF PMSVC PMFVC Set the timer setting value.	0 (0~65000)	

Group F08.3x: Swing Frequency Control

Parameter Code (Address)	Name	Description	Default (Range)	Reference Source
F08.30 (0x081E) STOP	Swing frequency control	V/F SVC FVC PMVF PMSVC PMFVC 0: Swing frequency control is deactivated. 1: Swing frequency control is activated.	0 (0~1)	F08.3x
F08.31 (0x081F) STOP	Swing frequency amplitude control	V/F SVC FVC PMVF PMSVC PMFVC LED "0" : Start mode 0: Automatic 1: Manual with terminal LED "00": Swing frequency amplitude control 0: Relative to center frequency 1: Relative to maximum frequency LED"000": Swing frequency state: 0: Store during stop 1: Not store during stop LED "0000": Storage of swing frequency state during power-off 0: Store 1: Not store	0000 (0000~0111)	
F08.32 (0x0820) STOP	Preset swing frequency	V/F SVC FVC PMVF PMSVC PMFVC Set the preset swing frequency.	0.00 Hz (0.00 - maximum frequency)	
F08.33 (0x0821) STOP	Preset swing frequency waiting time	V/F SVC FVC PMVF PMSVC PMFVC Set the preset swing frequency waiting time.	0.0s (0.0s~3600.0s)	
F08.34 (0x0822) STOP	Swing frequency amplitude	V/F SVC FVC PMVF PMSVC PMFVC Set the swing frequency amplitude.	10.0% (0.0%~50.0%)	
F08.35 (0x0823) STOP	Jump frequency	V/F SVC FVC PMVF PMSVC PMFVC Set the jump frequency.	10.0Hz (0.0Hz~50.0Hz)	

F08.36 (0x0824) STOP	Triangular wave rise time	V/F SVC FVC PMVF PMSVC PMFVC Set the rise time of triangular wave.	5.00s (0.1s~ 650.00s)	
F08.37 (0x0825) STOP	Triangular wave drop time	V/F SVC FVC PMVF PMSVC PMFVC Set the drop time of triangular wave.	5.00s (0.005s~ 650.00s)	

5.13 Group F09: Auxiliary Control 2

Group F09.0x: Maintenance Functions

Parameter Code (Address)	Name	Description	Default (Range)	Reference Source
F09.02 (0x0902) RUN	Device maintenance alarm selection	V/F SVC FVC PMVF PMSVC PMFVC LED "0": Cooling fan 0: Deactivated 1: Activated LED "00": Main relay 0: Deactivated 1: Activated LED "000": Reserved LED "0000": Reserved	0000 (0000~1111)	F09.0x
F09.03 (0x0903) STOP	Cooling fan maintenance setting	V/F SVC FVC PMVF PMSVC PMFVC Set in hours. Set to 0 when replacing the cooling fan with a new one.	0 (0~65535)	
F09.04 (0x0904) STOP	Main relay maintenance setting	V/F SVC FVC PMVF PMSVC PMFVC Set to 0.0% when replacing the main relay with a new one.	0.0% (0.0%~ 150.0%)	

5.14 Group F10: Protection Parameters

Group F10.0x: Current Protection

Parameter Code (Address)	Name	Description	Default (Range)	Reference Source
F10.00 (0x0A00) RUN	Overcurrent suppression function	V/F SVC FVC PMVF PMSVC PMFVC Automatically limit the output current to the set overcurrent suppression point to prevent overcurrent fault. 0: Suppression is always activated. 1: Activated during acceleration/deceleration, deactivated at constant speed.	0 (0~1)	F10.0x
F10.01 (0x0A01) RUN	Overcurrent suppression point	V/F SVC FVC PMVF PMSVC PMFVC Set the load current limiting level. 100% corresponds to the rated current of the inverter.	160.0% (0.0%~ 300.0%)	
F10.02 (0x0A02) RUN	Overcurrent suppression gain	V/F SVC FVC PMVF PMSVC PMFVC Set the response effect of overcurrent suppression.	100.0% (0.0%~ 500.0%)	

F10.03 (0x0A03) STOP	Current protection setting 1	V/F SVC FVC PMVF PMSVC PMFVC Set whether the current-related protection function is enabled. LED “0”: Cycle-by-cycle current limiting (CBC) 0: OFF 1: ON LED “00”: OC protection interference suppression 0: Normal 1: First degree interference suppression 2: Second degree interference suppression LED “000”: SC protection interference suppression 0: Normal 1: First degree interference suppression 2: Second degree interference suppression LED “0000”: Reserved	0001 (0000~f221)	
F10.04 (0x0A04) STOP	Current protection setting 2	V/F SVC FVC PMVF PMSVC PMFVC LED “0”: Three-phase current and protection selection 0: OFF 1: ON LED “00”: Three-phase current imbalance protection selection 0: OFF 1: ON	0001 (0000~0011)	
F10.05 (0x0A05) STOP	Current imbalance judgment threshold	V/F SVC FVC PMVF PMSVC PMFVC Compare the ratio of the maximum phase to the minimum phase in the three-phase current with this set point to judge whether the current imbalance occurs.	160% (0%~500%)	
F10.06 (0x0A06) STOP	Current imbalance filter coefficient	V/F SVC FVC PMVF PMSVC PMFVC The parameter value should be increased at a site with strong current fluctuation.	2.0s (0.0s~60.0s)	

Group F10.1x: Voltage Protection

Parameter Code (Address)	Name	Description	Default (Range)	Reference Source
F10.11 (0x0A0B) STOP	Bus overvoltage suppression function	V/F SVC FVC PMVF PMSVC PMFVC Slow down or stop acceleration or deceleration to prevent overvoltage fault when the bus voltage is higher than the overvoltage suppression point. LED “0”: overvoltage suppression function 0: OFF 1: ON LED “00”: over-excitation function 0: OFF 1: Activated only during deceleration 2: Activated during running	0011 (0000~0021)	F10.1x

F10.12 (0x0A0C) STOP	Bus overvoltage suppression point	V/F SVC FVC PMVF PMSVC PMFVC Set the bus voltage value that triggers the overvoltage suppression function.	T3: 750 V S2: 370 V (0 V - overvoltage point) T3 overvoltage point: 820 V S2 overvoltage point: 400 V	
F10.13 (0x0A0D) RUN	Bus overvoltage suppression gain	V/F SVC FVC PMVF PMSVC PMFVC Set the response effect of overvoltage suppression.	100.0% (0.0%~ 500.0%)	
F10.14 (0x0A0E) RUN	Dynamic brake enabling	V/F SVC FVC PMVF PMSVC PMFVC Set whether the dynamic brake function is enabled. 0: OFF 1: Enabled with overvoltage suppression disabled 2: Enabled with overvoltage suppression enabled	2 (0~2)	
F10.15 (0x0A0F) RUN	Dynamic brake action voltage	V/F SVC FVC PMVF PMSVC PMFVC Set the dynamic brake action voltage. The dynamic brake works when the bus voltage is higher than this value.	T3: 740 V S2: 360 V (0 V - overvoltage point) T3 overvoltage point: 820 V S2 overvoltage point: 400 V	
F10.16 (0x0A10) STOP	Bus undervoltage suppression function	V/F SVC FVC PMVF PMSVC PMFVC Limit the bus voltage decrease when the bus voltage is lower than the undervoltage suppression point by automatically adjusting the operating frequency to prevent undervoltage fault. 0: OFF 1: ON	0 (0~1)	
F10.17 (0x0A11) STOP	Bus undervoltage suppression point	V/F SVC FVC PMVF PMSVC PMFVC Set the bus voltage value that triggers the undervoltage suppression function.	T3: 430 V S2: 240 V (0 V - overvoltage point) T3 overvoltage point: 820 V S2 overvoltage point: 400 V	
F10.18 (0x0A12) RUN	Bus undervoltage suppression gain	V/F SVC FVC PMVF PMSVC PMFVC Set the response effect of undervoltage suppression.	100.0% (0.0%~ 500.0%)	

F10.19 (0x0A13) STOP	Bus undervoltage protection point	V/F SVC FVC PMVF PMSVC PMFVC Set the allowable lower limit of bus voltage. The inverter will report the undervoltage fault when the bus voltage is lower than this value.	T3: 320 V S2: 190 V (0 V - overvoltage point) T3 overvoltage point: 820 V S2 overvoltage point: 400 V	
----------------------------	--	---	---	--

Group F10.2x: Auxiliary Protection

Parameter Code (Address)	Name	Description	Default (Range)	Reference Source
F10.20 (0x0A14) STOP	Input and output phase loss protection selection	V/F SVC FVC PMVF PMSVC PMFVC Set whether the input and output phase loss protection function is enabled. LED “0”: Output phase loss protection function 0: OFF 1: ON LED “00”: Input phase loss protection function 0: OFF 1: ON. The inverter reports alarm A. iLF and keeps running when input phase loss is detected. 2: ON. The inverter reports error E. iLF and free stops when input phase loss is detected. LED “000”: Reserved LED “0000”: Reserved	0021 (0000~1121)	F10.2x
F10.21 (0x0A15) STOP	Input phase loss threshold	V/F SVC FVC PMVF PMSVC PMFVC Set the voltage detection percentage for the input phase loss detection function. 100% corresponds to the rated bus voltage.	10.0% (0.0%~30.0%)	
F10.22 (0x0A16) STOP	Grounding short circuit protection selection	V/F SVC FVC PMVF PMSVC PMFVC Set whether the ground short circuit protection function for the inverter output and cooling fan is enabled. LED “0”: Output short-to-ground protection function 0: OFF 1: Detection upon power-on 2: pre-running detection LED “00”: Fan short-to-ground protection function 0: OFF 1: ON LED “000”: Power short-to-ground protection function 0: OFF 1: ON	0111 (0000~0112)	

F10.23 (0x0A17) RUN	Fan ON/OFF control selection	V/F SVC FVC PMVF PMSVC PMFVC Set the running mode of the inverter's cooling fan. 0: The fan works after the inverter is powered on. 1: After the inverter stops, the fan runs according to the temperature, and the fan runs when the inverter is running. 2: After the inverter stop, the fan stops after the time set by F10.24, and runs according to the temperature.	1 (0~2)	
F10.24 (0x0A18) STOP	Fan control delay	V/F SVC FVC PMVF PMSVC PMFVC Set the time from releasing the running command to stop of the cooling fan.	30.00s (0.00s~ 600.00s)	
F10.25 (0x0A19) RUN	Inverter overheat oH1 warning detection level	V/F SVC FVC PMVF PMSVC PMFVC Set the temperature value for overheat warning of the inverter. Overheat warning is activated if the temperature is higher than this value.	80.0°C (0.0°C~ 100.0°C)	
F10.26 (0x0A1A) RUN	Motor overheat protection selection (Extension card)	V/F SVC FVC PMVF PMSVC PMFVC Set the motor overheat protection when an IO extension card is used. LED "0": Motor temperature sensor type 0: PT1000 1: KTY84 F10.26 is activated when the DIP switch on the IO extension card is flipped to KTY; The PT100 sensor is activated when the DIP switch on the IO extension card is flipped to PT100.	0x01 (0x00~0x01)	
F10.27 (0x0A1B) RUN	Motor overheat alarm level (Extension card)	V/F SVC FVC PMVF PMSVC PMFVC Set the temperature value for overheat fault of the inverter. Overheat fault is reported if the temperature is higher than this value.	110.0°C (0.0°C~ 200.0°C)	
F10.28 (0x0A1C) RUN	Motor overheat warning level (Extension card)	V/F SVC FVC PMVF PMSVC PMFVC Set the temperature value for overheat warning of the inverter. Overheat warning is activated if the temperature is higher than this value.	90.0°C (0.0°C~ F10.27)	

Group F10.3x: Load Protection

Parameter Code (Address)	Name	Description	Default (Range)	Reference Source
F10.32 (0x0A20) STOP	Load warning detection setting	<p>V/F SVC FVC PMVF PMSVC PMFVC</p> <p>Set the load warning detection mode and the warning mode of the inverter.</p> <p>LED “0”: Load warning detection 1 setting</p> <p>0: Do not detect 1: Detect overload 2: Detect overload only at constant speed 3: Detect underload 4: Detect underload only at constant speed</p> <p>LED “00”: warning setting for load warning detection 1</p> <p>0: Continue running and report A. Ld1 1: Free stop, and report E. Ld1</p> <p>LED “000”: Load warning detection 2 setting</p> <p>0: Do not detect 1: Detect overload 2: Detect overload only at constant speed 3: Detect underload 4: Detect underload only at constant speed</p> <p>LED “0000”: Warning setting for load warning detection 2</p> <p>0: Continue running and report A. Ld2 1: Free stop, and report E. Ld2</p>	0000 (0000~1414)	
F10.33 (0x0A21) STOP	Load warning detection level 1	<p>V/F SVC FVC PMVF PMSVC PMFVC</p> <p>Set the detection value of load warning 1.</p> <p>In VF control, 100% corresponds to the rated current of the motor.</p> <p>In vector control, 100% corresponds to the rated output torque of the motor.</p>	130.0% (0.0%~200.0%)	
F10.34 (0x0A22) STOP	Load warning detection time 1	<p>V/F SVC FVC PMVF PMSVC PMFVC</p> <p>Set the duration of detecting load warning 1. The load warning 1 will be detected if the load is higher than the detection value and last for this time.</p>	5.0s (0.0s~60.0s)	
F10.35 (0x0A23) STOP	Load warning detection level 2	<p>V/F SVC FVC PMVF PMSVC PMFVC</p> <p>Set the detection value of load warning 2.</p> <p>In VF control, 100% corresponds to the rated current of the motor.</p> <p>In vector control, 100% corresponds to the rated output torque of the motor.</p>	30.0% (0.0%~200.0%)	
F10.36 (0x0A24) STOP	Load warning detection time 2	<p>V/F SVC FVC PMVF PMSVC PMFVC</p> <p>Set the duration of detecting load warning 2. The load warning 2 will be detected if the load is higher than the detection value and last for this time.</p>	5.0s (0.0s~60.0s)	

Group F10.4x: Stall Protection

Parameter Code (Address)	Name	Description	Default (Range)	Reference Source
F10.40 (0x0A28) STOP	Excessive speed deviation protection action	V/F SVC FVC PMVF PMSVC PMFVC Set the warning detection mode and alarm mode when the deviation between the set speed and feedback speed of the motor is excessive. LED “0”: Detection selection 0: Do not detect 1: Detect only at constant speed 2: Always detect LED “00”: Alarm selection 0: Free stop and report a fault 1: Send an alarm and keep running	0000 (0000~0012)	F10.4x
F10.41 (0x0A29) STOP	Excessive speed deviation detection threshold	V/F SVC FVC PMVF PMSVC PMFVC Set the value for detecting excessive speed deviation. The value of 100% corresponds to F01.10 [Maximum frequency].	10.0% (0.0%~60.0%)	
F10.42 (0x0A2A) STOP	Excessive speed deviation detection time	V/F SVC FVC PMVF PMSVC PMFVC Set the duration for detecting excessive speed deviation. If the deviation between the set speed and the feedback speed is greater than F10.41 and lasts for this time, the excessive speed deviation is detected and a warning is sent.	2.0s (0.0s~60.0s)	
F10.43 (0x0A2B) STOP	Overspeed protection action	V/F SVC FVC PMVF PMSVC PMFVC Set the warning detection mode and alarm mode in the case of motor overspeed. LED “0”: Detection selection 0: Do not detect 1: Detect only at constant speed 2: Always detect LED “00”: Alarm selection 0: Free stop and report a fault 1: Send an alarm and keep running	0002 (0000~0012)	
F10.44 (0x0A2C) STOP	Overspeed detection threshold	V/F SVC FVC PMVF PMSVC PMFVC Set the value for detecting overspeed. The value of 100% corresponds to F01.10 [Maximum frequency].	110.0% (0.0%~150.0%)	
F10.45 (0x0A2D) STOP	Overspeed detection time	V/F SVC FVC PMVF PMSVC PMFVC Set the duration for detecting overspeed. If the feedback speed is greater than F10.44 and lasts for this time, the overspeed is detected and a warning is sent.	0.100s (0.000s~2.000s)	

Group F10.5x: Fault Recovery and Motor Overload

Parameter Code (Address)	Name	Description	Default (Range)	Reference Source
F10.50 (0x0A32) STOP	Fault self-recovery times	V/F SVC FVC PMVF PMSVC PMFVC Set how many times fault self-recovery is allowed. Note: The value of 0 indicates that the fault self-recovery function is disabled, while any other value indicates that the function is enabled.	0 (0~10)	F10.5x
F10.51 (0x0A33) STOP	Fault self-recovery interval	V/F SVC FVC PMVF PMSVC PMFVC Set the waiting time between a fault and fault recovery of the inverter.	1.0s (0.0s~100.0s)	
F10.52 (0x0A34) READ	Times of fault recovery	V/F SVC FVC PMVF PMSVC PMFVC Indicate how many times fault self-recovery has been performed. This parameter is read only.	0	
F10.55 (0x0A37) RUN	Motor overload model	V/F SVC FVC PMVF PMSVC PMFVC 0: Ordinary motor 1: Frequency conversion motor (50 Hz) 2: Frequency conversion motor (60 Hz) 3: Motor without cooling fan	0 (0~3)	
F10.56 (0x0A38) STOP	Motor insulation class	V/F SVC FVC PMVF PMSVC PMFVC 0: Insulation class A 1: Insulation class E 2: Insulation class B 3: Insulation class F 4: Insulation class H 5: Special class S	3 (0~5)	
F10.57 (0x0A39) STOP	Motor working system	V/F SVC FVC PMVF PMSVC PMFVC 0-1: S1 working system (continuous working) 2: S2 working system 3-9: Corresponding to S3-S9	0 (0~9)	
F10.58 (0x0A3A) STOP	Motor overload start threshold	V/F SVC FVC PMVF PMSVC PMFVC The starting threshold of motor overload. When the actual current is greater than this value, the overload increases on a cumulative basis.	105.0% (0.0%~130.0%)	
F10.59 (0x0A3B) STOP	Motor overload current coefficient	V/F SVC FVC PMVF PMSVC PMFVC Calculated motor overload current = actual current * motor overload current coefficient.	100.0% (0.0%~250.0%)	

5.15 Group F11: Keypad Parameters

Group F11.0x: Button Operation

Parameter Code (Address)	Name	Description	Default (Range)	Reference Source
F11.00 (0x0B00) RUN	Button lock selection	V/F SVC FVC PMVF PMSVC PMFVC 0: Not locked 1: Keypad function parameter modification is locked 2: Function parameters and non-start/stop buttons are locked 3: All function parameters and buttons are locked	0 (0~3)	F11.0x
F11.01 (0x0B01) RUN	Button lock password	V/F SVC FVC PMVF PMSVC PMFVC Used together with the button lock. Please remember the password after it is set, or you will not be able to operate the inverter after locking.	0 (0~65535)	
F11.02 (0x0B02) STOP	Keypad multi-function button selection	V/F SVC FVC PMVF PMSVC PMFVC 0: Deactivated 1: Reverse running button 2: Forward jogging button 3: Reverse jogging button 4: Switching between the keypad command channel and the terminal command channel 5: Switching between the keypad command channel and the communication command channel 6: Switching between the terminal command channel and the communication command channel 7: Switching between keypad, terminal and communication command channels	0 (0~7)	
F11.03 (0x0B03) STOP	Keypad STOP button setting	V/F SVC FVC PMVF PMSVC PMFVC 0: Non-keypad control mode is disabled 1: Non-keypad control mode stops according to the stopping mode 2: Non-keypad control mode free stop	0 (0~2)	

<p>F11.04 (0x0B04) STOP</p>	<p>Function of Up/Down button (Knob) in status interface</p>	<p>V/F SVC FVC PMVF PMSVC PMFVC LED “0”: Keypad up/down button used for modification 0: Deactivated 1: Adjust F01.09 frequency digital given 2: Adjust F13.01 PID digital given 3: Adjust the function code corresponding to F11.05 setting LED “00”: Storage after power-off 0: Frequency is not stored after power-off 1: Frequency is stored after power-off LED “000”: Action limit 0: Adjustable during running and stop 1: Adjustable only during running, and maintained during stop 2: Adjustable during running; reset during stop LED “0000”: Reserved</p>	<p>0011 (0000~0213)</p>	
<p>F11.05 (0x0B05) RUN</p>	<p>Parameter code setting quick change with Up/Down button</p>	<p>V/F SVC FVC PMVF PMSVC PMFVC LED “0” and LED “00”: Set yy in function parameter number Fxx.yy 00-99 LED “000” and LED “0000”: Set xx in function parameter number Fxx.yy 00-29 F11.04 is effective when the LED “0” is 3. For example, when F11.05 = xxyy, the up and down buttons of the keypad can be used to modify the setting of [Fxx.yy] quickly</p>	<p>0109 (0000~2999)</p>	
<p>F11.06 (0x0B06) STOP</p>	<p>Keypad command button selection</p>	<p>V/F SVC FVC PMVF PMSVC PMFVC LED “0”: Internal and external keypad button commands (Run command, and stop/reset commands) 0: External commands takes precedence. When external commands are effective, internal ones are ineffective 1: Internal commands takes precedence. When internal commands are effective, external ones are ineffective 2: Both internal and external commands are effective, and the stop/reset command takes precedence LED “00”: Reserved LED “000”: Reserved LED “0000”: Reserved</p>	<p>0000 (0000~2122)</p>	

F11.16 (0x0B10) RUN	The cyclic display parameter 2 in the second line of the keypad	V/F SVC FVC PMVF PMSVC PMFVC LED “0” and LED “00”: Set yy in monitoring parameter number Cxx.yy 00-63 LED “000” and LED “0000”: Set xx in monitoring parameter number Cxx.yy 00-07	0004 (0000~0763)	
F11.17 (0x0B11) RUN	The cyclic display parameter 3 in the second line of the keypad	V/F SVC FVC PMVF PMSVC PMFVC LED “0” and LED “00”: Set yy in monitoring parameter number Cxx.yy 00-63 LED “000” and LED “0000”: Set xx in monitoring parameter number Cxx.yy 00-07	0010 (0000~0763)	
F11.18 (0x0B12) RUN	The cyclic display parameter 4 in the second line of the keypad	V/F SVC FVC PMVF PMSVC PMFVC LED “0” and LED “00”: Set yy in monitoring parameter number Cxx.yy 00-63 LED “000” and LED “0000”: Set xx in monitoring parameter number Cxx.yy 00-07	0012 (0000~0763)	

Group F11.2x: Monitoring Parameter Control

Parameter Code (Address)	Name	Description	Default (Range)	Reference Source
F11.20 (0x0B14) RUN	Keypad display setting 1	V/F SVC FVC PMVF PMSVC PMFVC LED “0”: Output frequency display selection 0: Target Frequency 1: Running Frequency 2-F: Running frequency filtering. The larger the value, the better the filtering LED “00”: Reserved LED “000”: Power display dimension 0: Power display in percentage (%) 1: Power display in kilowatt (kW) LED “0000”: Reserved	0002 (0000~111F)	F11.2x
F11.21 (0x0B15) RUN	Speed display coefficient	V/F SVC FVC PMVF PMSVC PMFVC Adjust the display of C00.05 speed.	100.0% (0.0%~500.0%)	
F11.22 (0x0B16) RUN	Power display coefficient	V/F SVC FVC PMVF PMSVC PMFVC Adjust the display of C00.10 output power.	100.0% (0.0%~500.0%)	

F11.23 (0x0B17) RUN	Monitoring parameter group display selection	V/F SVC FVC PMVF PMSVC PMFVC LED "0": Monitoring parameter mapping 0:SI23 (新) 1: AC70 LED "00": Group C05 display selection 0: Automatically switch according to the control mode 1: Parameters related to VF mode 2: Parameters related to VC mode LED "000": C00.40 - C00.63 display selection 0: Not display 1: Display LED "0000": Communication fault code switching 0: Communication fault code table 1 (SI23 新) 1: Communication fault code table 2 (AC70) 2: Communication fault code table 3 (SI23 老)	0000 (0000~FFFF)	
F11.24 (0x0B18) RUN	Monitoring parameter filtering selection	V/F SVC FVC PMVF PMSVC PMFVC LED "0": Output current display filtering 0-F: The larger the value, the better the filtering LED "00": Reserved LED "000": Reserved LED "0000": Reserved	0002 (0000~000F)	
F11.25 (0x0B19) STOP	Display during motor Auto-tuning	V/F SVC FVC PMVF PMSVC PMFVC 0: Show the status of Auto-tuning process 1: Not show the status of Auto-tuning process	0 (0~1)	
F11.27 (0x0B1B) RUN	Fault self-recovery display selection	V/F SVC FVC PMVF PMSVC PMFVC LED "0": Display the fault during fault self-recovery 0: Not display 1: Display	0001 (0000~0001)	

Group F11.3x: Special Keypad Functions

Parameter Code (Address)	Name	Description	Default (Range)	Reference Source
F11.31 (0x0B1F) RUN	Lower limit voltage of keypad potentiometer	V/F SVC FVC PMVF PMSVC PMFVC Set the lower voltage limit of keypad potentiometer (the optional external single-line keypad is activated).	0.50V (0.00V~3.00V)	F11.3x
F11.32 (0x0B20) RUN	Corresponding value to lower limit of keypad potentiometer	V/F SVC FVC PMVF PMSVC PMFVC Set the corresponding value to the lower limit of keypad potentiometer (the optional external single-line keypad is activated).	0.00% (0.00%~100.00%)	

F11.33 (0x0B21) RUN	Upper limit voltage of keypad potentiometer	V/F SVC FVC PMVF PMSVC PMFVC Set the upper voltage limit of keypad potentiometer (the optional external single-line keypad is activated).	2.80V (0.00V~3.00V)	
F11.34 (0x0B22) RUN	Corresponding value to upper limit of keypad potentiometer	V/F SVC FVC PMVF PMSVC PMFVC Set the corresponding value to the upper limit of keypad potentiometer (the optional external single-line keypad is activated).	100.0% (0.00%~100.00%)	
F11.35 (0x0B23) STOP	Keypad potentiometer selection	V/F SVC FVC PMVF PMSVC PMFVC Set the keypad potentiometer channel. 0: Reserved 1: External keypad potentiometer	1 (0~1)	

5.16 Group F12: Communication Parameters

Group F12.0x: Modbus Communication Slave Parameters

Parameter Code (Address)	Name	Description	Default (Range)	Reference Source
F12.00 (0x0C00) STOP	Master/Slave selection	V/F SVC FVC PMVF PMSVC PMFVC 0: Slave 1: Master	0 (0~1)	F12.0x
F12.01 (0x0C01) STOP	Modbus communication address	V/F SVC FVC PMVF PMSVC PMFVC Set different values for different slave stations.	1 (1~247)	
F12.02 (0x0C02) STOP	Communication baud rate selection	V/F SVC FVC PMVF PMSVC PMFVC 0: 1,200 bps 1: 2,400 bps 2: 4,800 bps 3: 9,600 bps 4: 19,200 bps 5: 38,400 bps 6: 57,600 bps	3 (0~6)	
F12.03 (0x0C03) STOP	Modbus communication data format	V/F SVC FVC PMVF PMSVC PMFVC 0: (N, 8, 1) No check, data bits: 8, stop bits: 1 1: (E, 8, 1) Even parity check, data bits: 8, stop bits: 1 2: (O, 8, 1) Odd parity check, data bits: 8, stop bits: 1 3: (N, 8, 2) No check, data bits: 8, stop bits: 2 4: (E, 8, 2) Even parity check, data bits: 8, stop bits: 2 5: (O, 8, 2) Odd parity check, data bits: 8, stop bits: 2	0 (0~5)	

F12.04 (0x0C04) RUN	Modbus communication transmission response processing	V/F SVC FVC PMVF PMSVC PMFVC 0: Write with response 1: Write without response	0 (0~1)	
F12.05 (0x0C05) RUN	Modbus communication response delay	V/F SVC FVC PMVF PMSVC PMFVC Set the response delay of modbus communication.	0ms (0ms~5000ms)	
F12.06 (0x0C06) RUN	Modbus communication timeout fault time	V/F SVC FVC PMVF PMSVC PMFVC Set the timeout fault time of modbus communication timeout failure time.	1.0s (0.1s~100.0s)	
F12.07 (0x0C07) RUN	Communication disconnection processing	V/F SVC FVC PMVF PMSVC PMFVC 0: Do not detect timeout fault 1: Alarm and free Stop 2: Warning and keep running 3: Forced stop	0 (0~3)	
F12.08 (0x0C08) RUN	Receiving data (Address 0x3000) zero bias	V/F SVC FVC PMVF PMSVC PMFVC Conduct offset correction for the communication data of address 0x3000.	0.00 (-100.00~100.00)	
F12.09 (0x0C09) RUN	Receive data (Address 0x3000) gain	V/F SVC FVC PMVF PMSVC PMFVC Conduct linear correction for the communication data of address 0x3000.	100.0% (0.0%~500.0%)	

Group F12.1x: Modbus Master Parameters

Parameter Code (Address)	Name	Description	Default (Range)	Reference Source
F12.10 (0x0C0A) RUN	Master Loop Transmission Parameter Selection	V/F SVC FVC PMVF PMSVC PMFVC LED “0”, LED “00”, LED “000”, LED “0000” 0: Invalid 1: Master run command 2: Master given frequency 3: Master output frequency 4: Master upper limit frequency 5: Master given torque 6: Master output torque 7: Reserved 8: Reserved 9: Master PID setting A: Master PID Feedback B: Reserved C: Active current component	0031 (0000~CCCC)	F12.1x
F12.11 (0x0C0B) RUN	Custom Address Of Given Frequency	V/F SVC FVC PMVF PMSVC PMFVC Defines given frequency address, compatible with upper computer (PLC) instructions.	0000 (0000~FFFF)	

F12.12 (0x0C0C) RUN	Command Setting Custom Address Setting	V/F SVC FVC PMVF PMSVC PMFVC Defines command setting address, compatible with upper computer (PLC) instructions.	0000 (0000~FFFF)	
F12.13 (0x0C0D) RUN	Custom Address Of Forward Running Command	V/F SVC FVC PMVF PMSVC PMFVC Defines the address of forward running command	0001 (0000~FFFF)	
F12.14 (0x0C0E) RUN	Custom Address Of Reverse Running Command	V/F SVC FVC PMVF PMSVC PMFVC Defines the address of reverse running command	0002 (0000~FFFF)	
F12.15 (0x0C0F) RUN	Custom Address Of Stop Command	V/F SVC FVC PMVF PMSVC PMFVC Defines the address of stop command.	0005 (0000~FFFF)	
F12.16 (0x0C10) RUN	Custom Address Of Reset Command	V/F SVC FVC PMVF PMSVC PMFVC Defines the address of reset command.	0007 (0000~FFFF)	
F12.19 (0x0C13) RUN	Master Sending Command Selection	V/F SVC FVC PMVF PMSVC PMFVC Master sending command selection. 0: Send run command; 1: Send running status	0 (0~1)	

Group F12.2x: Special Modbus Functions

Parameter Code (Address)	Name	Description	Default (Range)	Reference Source
F12.20 (0x0C14) STOP	RJ45 interface communication mode selection	V/F SVC FVC PMVF PMSVC PMFVC 0: dual-line keypad communication 1: Modbus slave (Related parameters are set with F12.2x) 2: Modbus master (Send parameters are set with F12.1x) 3: Water tank host Note: Models of T3 45 KW and above only support dual-line Keypad communication	0 (0~3)	F12.2x
F12.21 (0x0C15) STOP	RJ45 interface communication address	V/F SVC FVC PMVF PMSVC PMFVC The slave address when RJ45 interface is for Modbus communication.	1 (1~247)	

F12.22 (0x0C16) STOP	RJ45 interface communicati on baud rate	V/F SVC FVC PMVF PMSVC PMFVC The baud rate when RJ45 interface is for Modbus communication. 0: 1200 bps 1: 2400 bps 2: 4800 bps 3: 9600 bps 4: 19200 bps 5: 38400 bps	3 (0~5)	
F12.23 (0x0C17) STOP	RJ45 interface data format	V/F SVC FVC PMVF PMSVC PMFVC The data format when RJ45 interface is for Modbus communication. 0: (N, 8, 1) No check, data bits: 8, stop bits: 1 1: (E, 8, 1) Even parity check, data bits: 8, stop bits: 1 2: (O, 8, 1) Odd parity check, data bits: 8, stop bits: 1 3: (N, 8, 2) No check, data bits: 8, stop bits: 2 4: (E, 8, 2) Even parity check, data bits: 8, stop bits: 2 5: (O, 8, 2) Odd parity check, data bits: 8, stop bits: 2	0 (0~5)	
F12.24 (0x0C18) RUN	RJ45 interface transmission response processing	V/F SVC FVC PMVF PMSVC PMFVC The transmission response processing when RJ45 interface is for Modbus communication. 0: Write with response 1: Write without response	0 (0~1)	
F12.25 (0x0C19) RUN	RJ45 interface communicati on response delay	V/F SVC FVC PMVF PMSVC PMFVC The response delay when RJ45 interface is for Modbus communication.	0ms (0ms~5000ms)	
F12.26 (0x0C1A) RUN	RJ45 interface communicati on timeout fault time	V/F SVC FVC PMVF PMSVC PMFVC The timeout fault time when RJ45 interface is for Modbus communication.	1.0s (0.1s~100.0s)	
F12.27 (0x0C1B) RUN	RJ45 interface communicati on disconnectio n processing	V/F SVC FVC PMVF PMSVC PMFVC The disconnection processing when RJ45 interface is for Modbus communication. 0: Do not detect timeout fault 1: Alarm and free stop 2: Warning and keep running 3: Forced stop	0 (0~3)	

Group F12.3x: PROFIBUS-DP Communication

Parameter Code (Address)	Name	Description	Default (Range)	Reference Source
--------------------------------	------	-------------	--------------------	---------------------

F12.30 (0x0C1E) RUN	DP card address	V/F SVC FVC PMVF PMSVC PMFVC Sets different values for different slave stations.	1 (1~247)	F12.3x
F12.31 (0x0C1F) RUN	DP baud rate	V/F SVC FVC PMVF PMSVC PMFVC Set baud rate according to DP communication		
F12.32 (0x0C20) STOP	DP master-slave communicatio n fault action	V/F SVC FVC PMVF PMSVC PMFVC 0: Do not detect 1: Alarm and free stop 2: Warning and keep running	0 (0~2)	

Note: The extension card does not support hot swapping.

Group F12.4x: CAN Communication

Parameter Code (Address)	Name	Description	Default (Range)	Reference Source
F12.40 (0x0C28) RUN	CAN Mode Selection	V/F SVC FVC PMVF PMSVC PMFVC 0: Slave station 1: Master station defined by VEICHI	0 (0~1)	F12.4x
F12.41 (0x0C29) RUN	CAN Communicatio n Address	V/F SVC FVC PMVF PMSVC PMFVC Set the address for the salve station	1 (1~247)	
F12.42 (0x0C2A) RUN	CAN Communicatio n Baud Rate	V/F SVC FVC PMVF PMSVC PMFVC 0: 20kbps 1: 50kbps 2: 100kbps 3: 125kbps 4: 250kbps 5: 500kbps 6: 1Mbps	3 (0~6)	
F12.43 (0x0C2B) RUN	CAN Master-Slave Communicatio n Fault Action	V/F SVC FVC PMVF PMSVC PMFVC 0: Do not detect 1: Alarm and free stop 2: Warning and keep running	0 (0~2)	

Note: The extension card does not support hot swapping.

Group F12.5x~Group F12.6x: extension Port EX-A and EX-B Communication

Parameter Code (Address)	Name	Description	Default (Range)	Reference Source
--------------------------------	------	-------------	--------------------	---------------------

F12.50 (0x0C32) RUN	Expansion port communication disconnection processing	V/F SVC FVC PMVF PMSVC PMFVC LED "0": EX-A port disconnection action mode 0: Do not detect 1: Alarm and free stop 2: Warning and keep running LED "00": EX-B port disconnection action mode 0: Do not detect 1: Alarm and free stop 2: Warning and keep running	0000 (0000~0022)	F12.5x
F12.51 (0x0C33) RUN	Extension port EX-A parameter updating	V/F SVC FVC PMVF PMSVC PMFVC 0: Do not update 1: Power-up has updated initial values 2: The initial values are restored for extension port EX-A parameters	0 (0~2)	
F12.52 (0x0C34) RUN	Extension port EX-B parameter updating	V/F SVC FVC PMVF PMSVC PMFVC 0: Do not update 1: Power-up has updated initial values 2: The initial values are restored for extension port EX-B parameters	0 (0~2)	
F12.53 (0x0C35) RUN	Extension port EX-A monitor frame address group 1	V/F SVC FVC PMVF PMSVC PMFVC Ones and LED"00"s: Lower 8 bits of address 00-63 Hundreds and LED"0000"s: Higher 8 bits of address 00-07	0001 (0000~0763)	
F12.54 (0x0C36) RUN	Extension port EX-A monitor frame address group 2	V/F SVC FVC PMVF PMSVC PMFVC The same as above	0002 (0000~0763)	
F12.55 (0x0C37) RUN	Extension port EX-A monitor frame address group 3	V/F SVC FVC PMVF PMSVC PMFVC The same as above	0007 (0000~0763)	
F12.56 (0x0C38) RUN	Extension port EX-A monitor frame address group 4	V/F SVC FVC PMVF PMSVC PMFVC The same as above	0011 (0000~0763)	
F12.57 (0x0C39) RUN	Extension port EX-B monitor frame address group 1	V/F SVC FVC PMVF PMSVC PMFVC The same as above	0001 (0000~0763)	
F12.58 (0x0C3A) RUN	Extension port EX-B monitor frame address group 2	V/F SVC FVC PMVF PMSVC PMFVC The same as above	0002 (0000~0763)	
F12.59 (0x0C3B) RUN	Extension port EX-B monitor frame address group 3	V/F SVC FVC PMVF PMSVC PMFVC The same as above	0007 (0000~0763)	

F12.60 (0x0C3C) RUN	Extension port EX-B monitor frame address group 4	V/F SVC FVC PMVF PMSVC PMFVC The same as above	0011 (0000~0763)	
---------------------------	--	--	---------------------	--

Note: The extension card does not support hot swapping.

5.17 Group F13: Process PID Control

F13.00~F13.06: PID Setting and Feedback

Parameter Code (Address)	Name	Description	Default (Range)	Reference Source
F13.00 (0x0D00) RUN	PID control given source	V/F SVC FVC PMVF PMSVC PMFVC 0: Keypad digital 1: Keypad potentiometer (optional external single-line keypad) 2: AI1 3: AI2 4: Reserved 5: Terminal pulse PUL 6: RS485 communication 7: Optional card 8: Terminal selection 9: Active current set via communication	0 (0~9)	F13.0x
F13.01 (0x0D01) RUN	Keypad digital of PID given /feedback	V/F SVC FVC PMVF PMSVC PMFVC PID given/feedback with keypad digital.	50.0% (0.0%~100.0%)	
F13.02 (0x0D02) RUN	PID given change time	V/F SVC FVC PMVF PMSVC PMFVC PID given change time. Acceleration/deceleration time between 0% and 100%.	1.00s (0.00s~60.00s)	
F13.03 (0x0D03) RUN	PID control feedback source	V/F SVC FVC PMVF PMSVC PMFVC 0: PID feedback with keypad digital 1: Keypad potentiometer (optional external single-line keypad) 2: AI1 3: AI2 4: Reserved 5: Terminal pulse PUL feedback 6: Feedback via RS485 communication 7: Option card 8: Terminal selection 9: Local active current	2 (0~9)	
F13.04 (0x0D04) RUN	Feedback signal low-pass filter time	V/F SVC FVC PMVF PMSVC PMFVC Feedback signal low-pass filter time.	0.010s (0.000s~6.000s)	
F13.05 (0x0D05) RUN	Feedback signal gain	V/F SVC FVC PMVF PMSVC PMFVC Feedback signal gain.	1.00 (0.00~10.00)	
F13.06 (0x0D06) RUN	Feedback signal range	V/F SVC FVC PMVF PMSVC PMFVC Feedback signal range.	100.0 (0.0~100.0)	

F13.07~F13.24: PID Adjustment

Parameter Code (Address)	Name	Description	Default (Range)	Reference Source
F13.07 (0x0D07) RUN	PID control selection	V/F SVC FVC PMVF PMSVC PMFVC LED"0": Feedback characteristic selection 0: Positive characteristic 1: Negative characteristic LED"00": Reserved LED"000": Reserved LED"0000": Differential adjustment attribute 0: Differentiate deviation 1: Differentiate feedback	0100 (0000~1111)	F13.1x
F13.08 (0x0D08) RUN	PID preset output	V/F SVC FVC PMVF PMSVC PMFVC 100% of the preset output corresponds to the maximum frequency output.	100.0% (0.0%~100.0%)	
F13.09 (0x0D09) RUN	PID preset output running time	V/F SVC FVC PMVF PMSVC PMFVC After PID control is started, the inverter output follows the PID preset output first, and it lasts for the PID preset output running time before running according to the PID closed-loop characteristics.	0.0s (0.0s~6500.0s)	
F13.10 (0x0D0A) RUN	PID control deviation limit	V/F SVC FVC PMVF PMSVC PMFVC The maximum allowable deviation of PID feedback value relative to the PID set value. When the feedback value is within this range, PID regulation stops and the output remains unchanged. Appropriate use of this function is helpful to minimize the conflict between the accuracy and stability of system output.	0.0s (0.0s~6500.0s)	
F13.11 (0x0D0B) RUN	Proportional gain P1	V/F SVC FVC PMVF PMSVC PMFVC Determines the regulation intensity of the whole PID regulator. The larger the gain, the greater the regulation intensity. However, too large gain is likely to generate oscillation.	0.100 (0.000~4.000)	
F13.12 (0x0D0C) RUN	Integral time I1	V/F SVC FVC PMVF PMSVC PMFVC Determines the integral regulation intensity of the PID regulator. The shorter the integral time, the greater the regulation intensity. The PID regulation will be invalid when the integral time is 0.	1.0s (0.0s~600.0s)	
F13.13 (0x0D0D) RUN	Differentiation time D1	V/F SVC FVC PMVF PMSVC PMFVC Determine the regulation intensity of the PID regulator for the deviation or feedback signal change rate. The regulation is variable according to the trends of change to suppress the changes in feedback signals.	0.000s (0.000s~6.000s)	

F13.14 (0x0D0E) RUN	Proportional gain P2	V/F SVC FVC PMVF PMSVC PMFVC Determines the regulation intensity of the whole PID regulator. The larger the gain, the greater the regulation intensity. However, too large gain is likely to generate oscillation.	0.100 (0.000~4.000)	
F13.15 (0x0D0F) RUN	Integral time I2	V/F SVC FVC PMVF PMSVC PMFVC Determines the integral regulation intensity of the PID regulator. The shorter the integral time, the greater the regulation intensity. The PID regulation will be invalid when the integral time is 0.	1.0s (0.0s~600.0s)	
F13.16 (0x0D10) RUN	Differentiation time D2	V/F SVC FVC PMVF PMSVC PMFVC Determine the regulation intensity of the PID regulator for the deviation or feedback signal change rate. The regulation is variable according to the trends of change to suppress the changes in feedback signals.	0.000s (0.000s~6.000s)	
F13.17 (0x0D11) RUN	PID parameter switching conditions	V/F SVC FVC PMVF PMSVC PMFVC 0: Do not switch 1: Switch with Xi terminal 2: Switch according to deviation	0 (0~2)	
F13.18 (0x0D12) RUN	Lower value of switching deviation	V/F SVC FVC PMVF PMSVC PMFVC The gain 1 parameter is used when the PID deviation is smaller than this value.	20.0% (0.0%~100.0%)	
F13.19 (0x0D13) RUN	Higher value of switching deviation	V/F SVC FVC PMVF PMSVC PMFVC The gain 2 parameter is used when the PID deviation is larger than this value.	80.0% (0.0%~100.0%)	
F13.21 (0x0D15) RUN	Differentiation limit	V/F SVC FVC PMVF PMSVC PMFVC The differential limit is used to set the range of the PID differential output. In a PID regulator, the function of differentiation is sensitive, as it is likely to cause system oscillation. Generally, the function of PID differentiation is limited to a small range.	5.0% (0.0%~100.0%)	
F13.22 (0x0D16) RUN	Upper limit of PID output	V/F SVC FVC PMVF PMSVC PMFVC Set the upper limit of PID output.	100.0% (0.0%~100.0%)	
F13.23 (0x0D17) RUN	Lower limit of PID output	V/F SVC FVC PMVF PMSVC PMFVC Set the lower limit of PID output.	0.0% (-100.0~F13.22)	
F13.24 (0x0D18) RUN	PID output filter time	V/F SVC FVC PMVF PMSVC PMFVC The PID output filter time is used to filter the PID output. The filter will weaken the sudden changes of the PID regulation output result and degrade the response performance of the process closed-loop system.	0.000s (0.000s~6.000s)	

F13.31 (0x0D1F) RUN	Sleep delay time	V/F SVC FVC PMVF PMSVC PMFVC After sleep judgment starts, the inverter enters sleep status after the sleep delay time (i.e. blocking output after decelerating to zero frequency.)	60.0s (0.0s~3600.0s)	
F13.32 (0x0D20) RUN	Wake-up deviation	V/F SVC FVC PMVF PMSVC PMFVC When the PID feedback characteristic is positive: The PID setting minus the wake-up deviation is compared with the PID feedback. The inverter will exits the sleep state and enters the normal running state if the difference remains greater than the PID feedback for the wake-up delay time. When the PID feedback characteristic is reverse: The PID setting plus the wake-up deviation is compared with the PID feedback. The inverter will exits the sleep state and enters the normal operation state if the sum remains greater than the PID feedback for the wake-up delay time.	5.0% (0.0%~50.0%)	
F13.33 (0x0D21) RUN	Wake-up delay time	V/F SVC FVC PMVF PMSVC PMFVC The inverter exits the sleep state and enters the normal operation state after the wake-up delay time if the wake-up conditions are met.	1.0s (0.0s~60.0s)	

5.18 Group F14: Multi-Speed and Simple PLC

F14.00~F14.14: Multi-Speed Frequency Setting

Parameter Code (Address)	Name	Description	Default (Range)	Reference Source
F14.00 (0x0E00) RUN	PLC multi-speed 1	V/F SVC FVC PMVF PMSVC PMFVC Set the frequency of the 1st stage in PLC program operation and multi-speed control.	10.00 Hz (0.00 Hz - maximum frequency)	F14.0x
F14.01 (0x0E01) RUN	PLC multi-speed 2	V/F SVC FVC PMVF PMSVC PMFVC Set the frequency of the 2nd stage in PLC program operation and multi-speed control.	20.00 Hz (0.00 Hz - maximum frequency)	
F14.02 (0x0E02) RUN	PLC multi-speed 3	V/F SVC FVC PMVF PMSVC PMFVC Set the frequency of the 3rd stage in PLC program operation and multi-speed control.	30.00 Hz (0.00 Hz - maximum frequency)	
F14.03 (0x0E03) RUN	PLC multi-speed 4	V/F SVC FVC PMVF PMSVC PMFVC Set the frequency of the 4th stage in PLC program operation and multi-speed control.	40.00 Hz (0.00 Hz - maximum frequency)	
F14.04 (0x0E04) RUN	PLC multi-speed 5	V/F SVC FVC PMVF PMSVC PMFVC Set the frequency of the 5th stage in PLC program operation and multi-speed control.	50.00 Hz (0.00 Hz - maximum frequency)	

F14.05 (0x0E05) RUN	PLC multi-speed 6	V/F SVC FVC PMVF PMSVC PMFVC Set the frequency of the 6th stage in PLC program operation and multi-speed control.	40.00 Hz (0.00 Hz - maximum frequency)	
F14.06 (0x0E06) RUN	PLC multi-speed 7	V/F SVC FVC PMVF PMSVC PMFVC Set the frequency of the 7th stage in PLC program operation and multi-speed control.	30.00 Hz (0.00 Hz - maximum frequency)	
F14.07 (0x0E07) RUN	PLC multi-speed 8	V/F SVC FVC PMVF PMSVC PMFVC Set the frequency of the 8th stage in PLC program operation and multi-speed control.	20.00 Hz (0.00 Hz - maximum frequency)	
F14.08 (0x0E08) RUN	PLC multi-speed 9	V/F SVC FVC PMVF PMSVC PMFVC Set the frequency of the 9th stage in PLC program operation and multi-speed control.	10.00 Hz (0.00 Hz - maximum frequency)	
F14.09 (0x0E09) RUN	PLC multi-speed 10	V/F SVC FVC PMVF PMSVC PMFVC Set the frequency of the 10th stage in PLC program operation and multi-speed control.	20.00 Hz (0.00 Hz - maximum frequency)	
F14.10 (0x0E0A) RUN	PLC multi-speed 11	V/F SVC FVC PMVF PMSVC PMFVC Set the frequency of the 11th stage in PLC program operation and multi-speed control.	30.00 Hz (0.00 Hz - maximum frequency)	
F14.11 (0x0E0B) RUN	PLC multi-speed 12	V/F SVC FVC PMVF PMSVC PMFVC Set the frequency of the 12th stage in PLC program operation and multi-speed control.	40.00 Hz (0.00 Hz - maximum frequency)	
F14.12 (0x0E0C) RUN	PLC multi-speed 13	V/F SVC FVC PMVF PMSVC PMFVC Set the frequency of the 13th stage in PLC program operation and multi-speed control.	50.00 Hz (0.00 Hz - maximum frequency)	
F14.13 (0x0E0D) RUN	PLC multi-speed 14	V/F SVC FVC PMVF PMSVC PMFVC Set the frequency of the 14th stage in PLC program operation and multi-speed control.	40.00 Hz (0.00 Hz - maximum frequency)	
F14.14 (0x0E0E) RUN	PLC multi-speed 15	V/F SVC FVC PMVF PMSVC PMFVC Set the frequency of the 15th stage in PLC program operation and multi-speed control.	30.00 Hz (0.00 Hz - maximum frequency)	

F14.22 (0x0E16) RUN	PLC segment 7 running time	V/F SVC FVC PMVF PMSVC PMFVC Set the running time for the 7th segment of PLC program.	10.0(s/m/h) (0.0(s/m/h)~ 6500.0(s/m/h))	
F14.23 (0x0E17) RUN	PLC segment 8 running time	V/F SVC FVC PMVF PMSVC PMFVC Set the running time for the 8th segment of PLC program.	10.0(s/m/h) (0.0(s/m/h)~ 6500.0(s/m/h))	
F14.24 (0x0E18) RUN	PLC segment 9 running time	V/F SVC FVC PMVF PMSVC PMFVC Set the running time for the 9th segment of PLC program.	10.0(s/m/h) (0.0(s/m/h)~ 6500.0(s/m/h))	
F14.25 (0x0E19) RUN	PLC segment 10 running time	V/F SVC FVC PMVF PMSVC PMFVC Set the running time for the 10th segment of PLC program.	10.0(s/m/h) (0.0(s/m/h)~ 6500.0(s/m/h))	
F14.26 (0x0E1A) RUN	PLC segment 11 running time	V/F SVC FVC PMVF PMSVC PMFVC Set the running time for the 11th segment of PLC program.	10.0(s/m/h) (0.0(s/m/h)~ 6500.0(s/m/h))	
F14.27 (0x0E1B) RUN	PLC segment 12 running time	V/F SVC FVC PMVF PMSVC PMFVC Set the running time for the 12th segment of PLC program.	10.0(s/m/h) (0.0(s/m/h)~ 6500.0(s/m/h))	
F14.28 (0x0E1C) RUN	PLC segment 13 running time	V/F SVC FVC PMVF PMSVC PMFVC Set the running time for the 13th segment of PLC program.	10.0(s/m/h) (0.0(s/m/h)~ 6500.0(s/m/h))	
F14.29 (0x0E1D) RUN	PLC segment 14 running time	V/F SVC FVC PMVF PMSVC PMFVC Set the running time for the 14th segment of PLC program.	10.0(s/m/h) (0.0(s/m/h)~ 6500.0(s/m/h))	
F14.30 (0x0E1E) RUN	PLC segment 15 running time	V/F SVC FVC PMVF PMSVC PMFVC Set the running time for the 15th segment of PLC program.	10.0(s/m/h) (0.0(s/m/h)~ 6500.0(s/m/h))	

F14.31~F14.45: PLC Direction and Acceleration/Deceleration Time Selection

Parameter Code (Address)	Name	Description	Default (Range)	Reference Source
-----------------------------	------	-------------	--------------------	---------------------

F14.31 (0x0E1F) RUN	Direction and acceleration/deceleration time of plc segment 1	V/F SVC FVC PMVF PMSVC PMFVC LED"0": Running direction of this stage (compared with the running command) 0: Same direction 1: Reverse direction LED"00": Acceleration/deceleration time of this stage 0: Acceleration/deceleration time 1 1: Acceleration/deceleration time 2 2: Acceleration/deceleration time 3 3: Acceleration/deceleration time 4 LED"000": Reserved LED"0000": Reserved	0000 (0000~0031)	F14.3x
F14.32 (0x0E20) RUN	Direction and acceleration/deceleration time of plc segment 2	Same as F14.31.	0000 (0000~0031)	
F14.33 (0x0E21) RUN	Direction and acceleration/deceleration time of plc segment 3	Same as F14.31.	0000 (0000~0031)	
F14.34 (0x0E22) RUN	Direction and acceleration/deceleration time of plc segment 4	Same as F14.31.	0000 (0000~0031)	
F14.35 (0x0E23) RUN	Direction and acceleration/deceleration time of plc segment 5	Same as F14.31.	0000 (0000~0031)	
F14.36 (0x0E24) RUN	Direction and acceleration/deceleration time of plc segment 6	Same as F14.31.	0000 (0000~0031)	
F14.37 (0x0E25) RUN	Direction and acceleration/deceleration time of plc segment 7	Same as F14.31.	0000 (0000~0031)	
F14.38 (0x0E26) RUN	Direction and acceleration/deceleration time of plc segment 8	Same as F14.31.	0000 (0000~0031)	
F14.39 (0x0E27) RUN	Direction and acceleration/deceleration time of plc segment 9	Same as F14.31.	0000 (0000~0031)	

F14.40 (0x0E28) RUN	Direction and acceleration/ deceleration time of plc segment 10	Same as F14.31.	0000 (0000~0031)	
F14.41 (0x0E29) RUN	Direction and acceleration/ deceleration time of plc segment 11	Same as F14.31.	0000 (0000~0031)	
F14.42 (0x0E2A) RUN	Direction and acceleration/ deceleration time of plc segment 12	Same as F14.31.	0000 (0000~0031)	
F14.43 (0x0E2B) RUN	Direction and acceleration/ deceleration time of plc segment 13	Same as F14.31.	0000 (0000~0031)	
F14.44 (0x02C) RUN	Direction and acceleration/ deceleration time of plc segment 14	Same as F14.31.	0000 (0000~0031)	
F14.45 (0x0E2D) RUN	Direction and acceleration/ deceleration time of plc segment 15	Same as F14.31.	0000 (0000~0031)	

5.19 Group F21: Solar Pump Special Parameters

Parameter (address)	Function Description	Range of settings and definition	Factory default (setting range)	Notes
F21.00(0x5500)	Solar pump drive control mode	LED0 Mode selection 0:Variable frequency control mode 1:CVT mode for solar 2:MPPT mode for solar LED00 Operation selection 0: Continuous Operation 1:Inermittent Operation 2: Pump Cleanr LED000 Reserved LED0000 Motor selection 0:Three-phase Motor 1:Single-phase Motor	0002	
F21.01(0x5501)	Running control mode	0:Stop 1:Running 2:Sleep 3:Low speed protection 4:Dry run protection 5:Over current protection 6:Minimum power protection 7:Water fulfilled protection	Read Only	
F21.02(0x5502)	VOC voltage (display)	0.0V~999.9V	Read only	
F21.03(0x5503)	CVT target voltage	70.0%~95.0%	81.0%	

F21.04(0x5504)	MPPT upper limit voltage	20.0% ~ 200.0%	100.0%	
F21.05(0x5505)	MPPT lower limit voltage	20.0% ~ 200.0%	50.0%	
F21.06(0x5506)	Frequency adjusting gain	0.1% ~ 500.0%	10.0% (AM) 40.0% (PMSM)	
F21.07(0x5507)	MPPT search interval	0.1s ~ 100.0s	1.0s	
F21.08(0x5508)	MPPT regulating gain	0 ~ 9999	100	
F21.09(0x5509)	Quick-drop frequency gain	0 ~ 20	2	
F21.10(0x550A)	Frequency adjusting filter time	0.001s ~ 2.000s	0.001	
F21.11(0x550B)	Go to sleep mode voltage	0V ~ 1000V	0V	
F21.12(0x550C)	Wake up restore voltage	0V ~ 1000V	400V	
F21.13(0x550D)	Sleeping stop restore waiting time	0.0s ~ 3000.0s	10.0s	
F21.14(0x550E)	Low speed protection detect frequency	0.00Hz ~ 300.00Hz	10.00Hz	
F21.15(0x550F)	Low speed protection detect time	0.0s ~ 3000.0s	10.0s	
F21.16(0x5510)	Low speed protection restore working time	0.0s ~ 3000.0s	10.0s	
F21.17(0x5511)	Dry run protection detect current	0.0A ~ 999.9A	0.0A	
F21.18(0x5512)	Dry run protection detect time	0.0s ~ 3000.0s	10.0s	
F21.19(0x5513)	Dry run auto restore working time	0.0s ~ 3000.0s	10.0s	
F21.20(0x5514)	Over current point setting	0.0A ~ 999.9A	0.0A	
F21.21(0x5515)	Over current protection detect time	0.0s ~ 3000.0s	10.0s	
F21.22(0x5516)	Over current protection auto restore working time	0.0s ~ 3000.0s	10.0s	
F21.23(0x5517)	Input minimum power protection power point setting	0.00kW ~ 650.00kW	0.00kW	
F21.24(0x5518)	Minimum power protection detect time	0.0s ~ 3000.0s	10.0s	
F21.25(0x5519)	Minimum power protection auto restore working time	0.0s ~ 3000.0s	10.0s	

F21.26(0x551A)	Fault alarm restore mode	0:Auto reset;1:Reset by manual LED0:Low speed protection LED1:Dry run LED2:Over current protection LED3: Minimum power protection	0000	
F21.27(0x551B)	Water fulfilled detect time	0.0s~3000.0s	10.0s	
F21.28(0x551C)	Water fulfilled restore time	0.0s~3000.0s	10.0s	
F21.29(0x551D)	reserve			
F21.30(0x551E)	DC current revise offset	0.00A~99.99A	0.01A	
F21.31(0x551F)	DC current revise proportion gain	0.0%~999.9%	100.0%	
F21.32(0x5520)	Power curve point 0	0.00kW~99.99kW	0.50kW	
F21.33(0x5521)	Power curve point 1	0.00kW~99.99kW	1.00kW	
F21.34(0x5522)	Power curve point 2	0.00kW~99.99kW	1.50kW	
F21.35(0x5523)	Power curve point 3	0.00kW~99.99kW	2.00kW	
F21.36(0x5524)	Power curve point 4	0.00kW~99.99kW	2.50kW	
F21.37(0x5525)	Flow curve point 0	0.0m ³ /h~999.9m ³ /h	0.0m ³ /h	
F21.38(0x5526)	Flow curve point 1	0.0m ³ /h~999.9m ³ /h	5.0m ³ /h	
F21.39(0x5527)	Flow curve point 2	0.0m ³ /h~999.9m ³ /h	10.0m ³ /h	
F21.40(0x5528)	Flow curve point 3	0.0m ³ /h~999.9m ³ /h	15.0m ³ /h	
F21.41(0x5529)	Flow curve point 4	0.0m ³ /h~999.9m ³ /h	20.0m ³ /h	
F21.42(0x552A)	Flow calculating revise offset	0.0m ³ ~999.9m ³	0.0m ³	
F21.43(0x552B)	Flow calculating revise gain	0.0%~999.9%	100.0%	
F21.44(0x552C)	Power per day/ generated power per day reset period	0.0h~24.0h	7.0h	
F21.45(0x552D)	Reserved			
F21.46(0x552E)	Photovoltaic pump function selection 1	0:Invalid 1:Valid LED0:Constant torque frequency limit selection LED1:Reserved LED2:Voltage rising update Voc voltage LED3: Fast frequency falling function	1100H	
F21.47(0x552F)	Fast frequency falling threshold	3.0%~15.0%	5.0%	
F21.48(0x5530)	Constant torque frequency limit coefficient	80.0%~150.0%	100.0%	
F21.49(0x5531)	Sudden voltage increase threshold	0.0%~20.0%	5.0%	
F21.50(0x5532)	Reserved			
F21.51(0x5533)	Reserved			
F21.52(0x5534)	Reserved			
F21.53(0x5535)	Functional selection	LED0: Inermittent Operation Storage 0:None; 1:Stored LED00:Stop Mode When Alarm 0:Slow down 1:Free stop LED000:Reserved LED0000:Reserved	0000	

F21.54(0x5536)	Times of Inermittent Operation	0~1000	0	
F21.55(0x5537)	Start time of Inermittent Operation	0min~3000min	0	
F21.56(0x5538)	Stop time of Inermittent Operation	0min~3000min	0	
F21.57(0x5539)	Pump Clean Frequency	0.00Hz~300.00Hz	25.00Hz	
F21.58(0x553A)	FWD Running Time	0s~3000s	30s	
F21.59(0x553B)	REV Running Time	0s~3000s	30s	
F21.60(0x553C)	Cycle Times	0~60	5	
F21.61(0x553D)	Power Limitation	0.0~1000.0	0.0	
F21.62(0x553E)	Power Limitation Kp	0.0~100.0	1.0	
F21.63(0x553F)	Power Limitation Ki	0.0~100.0	1.0	

5.20 Group C0x: Monitoring Parameters

Group C00.xx: Basic Monitoring

Parameter Code (Address)	Name	Minimum Unit	Description
C00.00 (0x2100)	Given frequency	0.01Hz/ 0.1Hz	Display the absolute value of given frequency of the inverter.
C00.01 (0x2101)	Output frequency	0.01Hz/ 0.1Hz	Display the output frequency of the inverter.
C00.02 (0x2102)	Output current	0.1A	Display the output current of the inverter.
C00.03 (0x2103)	Input voltage	0.1V	Display the input voltage of the inverter.
C00.04 (0x2104)	Output voltage	0.1V	Display the output voltage of the inverter.
C00.05 (0x2105)	Mechanical speed	1rpm	Display the mechanical speed of the motor.
C00.06 (0x2106)	Given torque	0.1%	Display the set torque of the inverter. Effective when vector is selected as the control mode.
C00.07 (0x2107)	Output torque	0.1%	Display the output torque of the inverter.
C00.08 (0x2108)	PID given	0.1%	Display the set value of PID. Effective when PID is selected for the frequency setting channel.
C00.09 (0x2109)	PID feedback value	0.1%	Display the feedback value of PID . Effective when PID is selected for the frequency setting channel.
C00.10 (0x210A)	Output power	0.1%	Display the current output power of the inverter.
C00.11 (0x210B)	DC-Bus voltage	0.1V	Display the current bus voltage of the inverter.
C00.12 (0x210C)	Module temperature 1	0.1°C	The internal temperature of the inverter.
C00.13 (0x210D)	Module temperature 2	0.1°C	--

C00.14 (0x210E)	Input terminal X connection status	--	The status of the multi-function input terminals is displayed as 1 (ON) or 0 (OFF). For example, when terminals X1 and X2 are ON, C00.14 is displayed as $\begin{matrix} 11 \\ 11111111 \end{matrix}$.
C00.15 (0x210F)	Output terminal Y connection status	--	The status of the multi-function output terminals is displayed as 1 (ON) or 0 (OFF). For example, when terminal Y and relay are ON, C00.15 is displayed as $\begin{matrix} 11 \\ 11111111 \end{matrix}$.
C00.16 (0x2110)	Analog AI1 input value	0.001V/0.01mA	F05.41 is used to select voltage or current input. F05.41 set to "0" indicates voltage input, while "1" indicates current input.
C00.17 (0x2111)	Analog AI2 input value	0.001V/0.01mA	F05.42 is used to select voltage or current input. F05.42 set to "0" indicates voltage input, while "1" indicates current input.
C00.18 (0x2112)	Reserved	--	--
C00.19 (0x2113)	Pulse signal PUL input value	0.001kHz/0.01kHz	The decimal point is determined by the selection in F05.30. There are 3 decimal digits when F05.30 is 0, and there are 2 decimal digits in other cases.
C00.20 (0x2114)	Analog output AO	0.01V/0.01mA/0.01kHz z	F06.00 is used to select 0 V - 10 V or 0 mA - 20 mA, or pulse output.
C00.21 (0x2115)	Expanded AO output	0.01V/0.01mA	It is possible to select 0 V - 10 V or 0 mA - 20 mA, for use with an option card.
C00.22 (0x2116)	Counter value	1	--
C00.23 (0x2117)	Running time after power-on	0.1 hours	--
C00.24 (0x2118)	Cumulative running time of this inverter	Hours	--
C00.25 (0x2119)	Inverter capacity	0.1kVA	Capacity of the inverter.
C00.26 (0x211A)	Rated voltage of inverter	1V	The rated voltage of the inverter.
C00.27 (0x211B)	Rated current of inverter	0.1A	The rated current of the inverter.
C00.28 (0x211C)	Software version	00.00	The version of the inverter software.
C00.29 (0x211D)	PG feedback frequency	0.01Hz	The PG card detects the feedback signals from the encoder and converts them into a frequency values.
C00.30 (0x211E)	Timer time	1 second/ minute/hour r	The unit is determined by parameter F08.07.
C00.31 (0x211F)	PID output value	0.00%	The output value of the process PID control and regulation.
C00.32 (0x2120)	Inverter Software Sub-Version	1	The time for updating the inverter software.
C00.33 (0x2121)	Encoder feedback angle	1	The angle of the encoder feedback.
C00.34 (0x2122)	Z pulse cumulative error	1	The ABZ encoder detects A and B signals with Z pulses to judge whether the encoder has lost pulses.
C00.35 (0x2123)	Z pulse count	1	The count value of ABZ encoder passing Z pulses.

C00.36 (0x2124)	Fault warning code	1	The number corresponding to the fault code is displayed, and "0" indicates no fault.
C00.37 (0x2125)	Cumulative Power Consumption (low level)	1	Total power consumption = [C00.37 + C00.38 * 10,000] ^o
C00.38 (0x2126)	Cumulative power consumption (high level)	1	
C00.39 (0x2127)	Power factor angle	1 ^o	--

Group C01.xx: Fault Monitoring

Parameter Code (Address)	Name	Minimum Unit	Description
C01.00 (0x2200)	Diagnostic information on fault type	--	Display the fault in characters.
C01.01 (0x2201)	Fault diagnosis information	1	Display the fault code and fault sub-code in numbers. Check the corresponding solutions in the fault diagnosis section.
C01.02 (0x2202)	Output frequency upon fault	0.01Hz/ 0.1Hz	Display the output frequency at when the fault occurred.
C01.03 (0x2203)	Output voltage upon fault	0.1V	Display the output voltage at when the fault occurred.
C01.04 (0x2204)	Output current upon fault	0.1A	Display the output current at when the fault occurred.
C01.05 (0x2205)	DC-Bus voltage upon fault	0.1V	Display the bus voltage when the fault occurred.
C01.06 (0x2206)	Module temperature upon fault	0.1	Displays the temperature of the inverter's internal module when the fault occurred.
C01.07 (0x2207)	Inverter status upon fault	0x0000	LED"0": Running direction 0: Forward 1: Reverse LED"00": Running status 0: Stopped 1: Constant speed 2: Acceleration 3: Deceleration LED"000": Overvoltage and overcurrent 0: Normal 1: Overvoltage 2: Overcurrent 3: Overvoltage and overcurrent LED LED"0000": Reserved
C01.08 (0x2208)	Input terminal status upon fault	--	The status of the multi-function input terminals is displayed as 1 (ON) or 0 (OFF) when the fault occurred. For example, when terminals X1 and X2 are ON, C01.08 is displayed as $\begin{matrix} & \\ & \\ & \\ & \\ & \\ & \\ & \\ & \\ & \\ & \end{matrix}$.
C01.09 (0x2209)	Output terminal status upon fault	--	The status of the multi-function output terminals is displayed as 1 (ON) or 0 (OFF) when the fault occurred. For example, when terminal Y and the relay are ON, C01.09 is displayed as $\begin{matrix} & \\ & \\ & \\ & \\ & \\ & \\ & \\ & \\ & \\ & \end{matrix}$.
C01.10 (0x220A)	Last fault type	--	Display the fault in characters.

C01.11 (0x220B)	Diagnosis Information of Last Fault	1	Display the fault code and fault sub-code in numbers. Check the corresponding solutions in the fault diagnosis section.
C01.12 (0x220C)	Operating frequency of last fault	0.01Hz/ 0.1Hz	Display the output frequency at when the fault occurred.
C01.13 (0x220D)	Output voltage of last fault	0.1V	Display the output voltage at when the fault occurred.
C01.14 (0x220E)	Output current of last fault	0.1A	Display the output current at when the fault occurred.
C01.15 (0x220F)	Bus voltage of last fault	0.1V	Display the bus voltage where the fault occurred.
C01.16 (0x2210)	Module temperature upon last fault	0.1	Display the temperature of the inverter's internal module when the fault occurred.
C01.17 (0x2211)	Inverter status of last fault	0x0000	LED"0": Running direction 0: Forward 1: Reverse LED"00": Running status 0: Stopped 1: Constant speed 2: Acceleration 3: Deceleration LED"000": Overvoltage and overcurrent 0: Normal 1: Overvoltage 2: Overcurrent 3: Overvoltage and Overcurrent LED LED"0000": Reserved
C01.18 (0x2212)	Input terminal status of last fault	--	The status of the multi-function input terminals is displayed as 1 (ON) or 0 (OFF) when the fault occurred. For example, when terminals X1 and X2 are ON, C01.08 is displayed as $\begin{matrix} 1 \\ 1 \\ 1 \\ 1 \\ 1 \\ 1 \\ 1 \\ 1 \\ 1 \\ 1 \end{matrix}$.
C01.19 (0x2213)	Output terminal status of last fault	--	The status of the multi-function output terminals is displayed as 1 (ON) or 0 (OFF) when the fault occurred. For example, when terminal Y and the relay are ON, C01.09 is displayed as $\begin{matrix} 1 \\ 1 \\ 1 \\ 1 \\ 1 \\ 1 \\ 1 \\ 1 \\ 1 \\ 1 \end{matrix}$.
C01.20 (0x2214)	Fault types of the first two times	--	Display the fault in characters.
C01.21 (0x2215)	Diagnosis information of the first two times	1	Display the fault code and fault sub-code in numbers. Check the corresponding solutions in the fault diagnosis section.
C01.22 (0x2216)	Fault types of the first three times	--	Display the fault in characters.
C01.23 (0x2217)	Diagnosis information of the first three times	1	Display the fault code and fault sub-code in numbers. Check the corresponding solutions in the fault diagnosis section.

Group C02.xx: Application Monitoring

Parameter Code (Address)	Name	Minimum Unit	Description
C02.00 (0x2300)	PID setting	0.1%	Display the PID set value.
C02.01 (0x2301)	PID feedback	0.1%	Display the PID feedback value.

C02.02 (0x2302)	PID output	0.1%	Display the PID output value.
C02.03 (0x2303)	PID Control status	1	--
C02.05 (0x2305)	PLC running stage	1	--
C02.06 (0x2306)	PLC segment frequency	0.01Hz	--
C02.07 (0x2307)	PLC segment running time	0.1(s/m/h)	The unit is related to the LED"00" setting of F14.15: second (s), minute (m), hour (h)
C02.08 (0x2308)	Forward and reverse command setting	1	--
C02.09 (0x2309)	Jogging command setting	1	--
C02.10 (0x230A)	AI1 pre-correction voltage/current	0.01V/0.01mA	F05.41 is used to select voltage or current input. F05.41 set to "0" indicates voltage input, while "1" indicates current input.
C02.11 (0x230B)	AI2 pre-correction voltage/current	0.01V/0.01mA	F05.42 is used to select voltage or current input. F05.42 set to "0" indicates voltage input, while "1" indicates current input.
C02.12 (0x230C)	AO pre-correction voltage/current	0.01V/0.01mA	F06.00 is used to select voltage or current output. F06.00 set to "0" indicates voltage output, while "1, 2" indicate current output.
C02.13 (0x230D)	Expanded AO pre-correction voltage/current	0.01V/0.01mA	F06.10 is used to select voltage or current output. F06.10 set to "0" indicates voltage output, while "1, 2" indicate current output.
C02.14 (0x230E)	Reserved	--	--
C02.15 (0x230F)	Inverter overload timing coefficient	0.1%	100% indicates that the overload time has elapsed.
C02.16 (0x2310)	Motor overload timing coefficient	0.1%	100% indicates that the overload time has elapsed.
C02.17~C02.18 (0x2311~0x2312)	Reserved		--
C02.19 (0x2313)	Times of cycle-by-cycle current limiting	1	The number of times when cycle-by-cycle current limiting has occurred.
C02.20~C02.24 (0x2314~0x2318)	Reserved		--
C02.25 (0x2319)	IO extension card analog 1	1	A per-unit value within the range of 0-10,000.
C02.26 (0x231A)	IO extension card analog 2	1	A per-unit value within the range of 0-10,000.
C02.27 (0x231B)	IO extension card analog 3	1	A per-unit value within the range of 0-10,000.
C02.28 (0x231C)	IO extension card input terminal status	1	Bit 0 - bit 4 correspond to the status of X6 - X10 terminals. 0: Invalid; 1: Valid.

C02.29 (0x231D)	Motor temperature detected by IO extension card	0.1 degrees	
C02.30 (0x231E)	IO extension card PUL count low level	1	
C02.31 (0x231F)	IO extension card PUL count high level	1	Total count = [C02.30 + C02.31*65535].
C02.32~C02.47 (0x2320~0x232F)	Stored parameter 1 after power-off - stored parameter 16 after power-off	1	Used with an option card.
C02.48~C02.49 (0x2330~0x2331)	Reserved	1	
C02.50~C02.59 (0x2332~0x233B)	Cache register 0 - cache register 9	1	Used with an option card.
C02.60 (0x233C)	Extension card A software version	1	The extension card software version on extension port A.
C02.61 (0x233D)	Extension card B software version	1	The extension card software version on extension port B.
C02.62 (0x233E)	External keypad version	1	The version of external keypad software.
C02.63 (0x233F)	Reserved	1	

Group C03.xx: Maintenance and Tension Control Monitoring

Parameter Code (Address)	Name	Minimum Unit	Description
C03.00 (0x2400)	Running time after power-up	0.1 hours	
C03.01 (0x2401)	Cumulative running time (hour)	1 hour	
C03.02 (0x2402)	Cumulative power-on time (hour)	1 hour	
C03.03 (0x2403)	Cumulative power-on time (minute)	1 minute	
C03.04 (0x2404)	Cooling fan running time	1 hour	
C03.05 (0x2405)	Cooling fan maintenance	1%	
C03.06 (0x2406)	Reserved	1%	
C03.07 (0x2407)	Main relay maintenance	1%	
C03.08~C03.19 (0x2408~0x2413)	Reserved		
C03.20 (0x2414)	Final tension setting	0.1N	The number of decimal places depends on the hundreds digit of F16.03.
C03.21 (0x2415)	Initial roll diameter value	1mm	
C03.22 (0x2416)	Current value of linear velocity	0.1m/min	
C03.23 (0x2417)	Current value of roll diameter	1mm	
C03.24 (0x2418)	Tension channel torque set value	0.1%	
C03.25 (0x2419)	Tension PID given	0.1%	
C03.26 (0x241A)	Tension PID feedback	0.1%	
C03.27 (0x241B)	Tension PID output	0~10000	
C03.28 (0x241C)	Static friction compensation value	0.1%	
C03.29 (0x241D)	Dynamic friction compensation value	0.1%	
C03.30 (0x241E)	Total friction compensation value	0.1%	

C03.31~C03.39 (0x241F~0x2427)	Reserved (tension function)		
C03.50 (0x2432)	Machine code 1	1	
C03.51 (0x2433)	Machine code 2	1	
C03.52 (0x2434)	Machine code 3	1	

Group C04.xx: Photovoltaic Pump Special Monitor Parameters

Function code	Function name	Setting range and definition	Default setting
C04.00(0x2500)	Frequency reference	0.01Hz	Read only
C04.01(0x2501)	Output frequency	0.01Hz	Read only
C04.02(0x2502)	Output current	0.1A	Read only
C04.03(0x2503)	Cycle Times 1		Read only
C04.04(0x2504)	Cycle Times 2		Read only
C04.05(0x2505)	Reserved		Read only
C04.06(0x2506)	Operation Time	1min	Read only
C04.07(0x2507)	Stop Time	1min	Read only
C04.08(0x2508)	Reserved		Read only
C04.09(0x2509)	Reserved		Read only
C04.10(0x250A)	Output power	0.01kW	Read only
C04.11(0x250B)	DC bus voltage	0.1V	Read only
C04.12(0x250C)	Module temperature 1	0.1°C	Read only
C04.13(0x250D)	Status of MPPT		Read only
C04.14(0x250E)	Solar Panel Operation Point	0.1%	Read only
C04.15(0x250F)	Solar Panel Voc	0.1V	Read only
C04.16(0x2510)	Frequency Searching Period		Read only
C04.17(0x2511)	Solar Target Frequency	0.10Hz	Read only
C04.30(0x251E)	DC current	0.01A	Read only
C04.31(0x251F)	Flow speed	0.1m ³ /h	Read only
C04.32(0x2520)	Voc voltage	0.1V	Read only
C04.33(0x2521)	Flow per day	0.1m ³	Read only
C02.34(0x2522)	Cumulative total flow(low position)	0.1m ³	Read only
C02.35(0x2523)	Cumulative total flow(high position)	0.1km ³	Read only
C02.36(0x2524)	Generated power per day	0.01kWh	Read only
C02.37(0x2525)	Cumulative total generated power (low position)	0.01kWh	Read only
C02.38(0x2526)	Cumulative total generated power (high position)	0.1MWh	Read only

Group C05.xx: Control Monitoring

This group of parameters is used for monitoring the internal control parameters of the inverter, together with an option card and allows secondary function development.

Group C06.xx: EX-A Monitoring

This group of parameters is used for control the monitoring values on the option card (connected to the EX-A port). See the instructions of the option card for description of monitoring parameters.

0x2007 /0x3007	Torque control reverse speed limit	R/W	0.0% (0.0%~100.0%)	The torque control reverse speed limit is set via communication.
0x2008 /0x3008	PID given	R/W	0.0% (0.0%~100.0%)	The PID set point is set via communication.
0x2009 /0x3009	PID feedback	R/W	0.0% (0.0%~100.0%)	The PID feedback value is set via communication.
0x200A /0x300A	VF separation voltage setting	R/W	0.0% (0.0%~100.0%)	An application parameter exclusive to inverter power supply.
0x200B /0x300B	Tension setting	R/W	0.0% (0.0%~100.0%)	Unit-Specific tension parameter.
0x200C /0x300C	Roll diameter setting	R/W	0.0% (0.0%~100.0%)	Unit-Specific tension parameter.
0x200D /0x300D	Linear speed setting	R/W	0.0% (0.0%~100.0%)	Unit-Specific tension parameter.
0x200E /0x300E	Acceleration time 1	R/W	0.00s 0.00s~600.00s	Reads and writes the value of F01.22.
0x200F /0x300F	Deceleration time 1	R/W	0.00s (0.00s~600.00s)	Reads and writes the value of F01.23.
0x2010 /0x3010	Fault warning & warning code	R	0 (0~65535)	1-127 are fault codes, 128-159 are warning codes, and 0 indicates no fault.
0x2011 /0x3011	Torque current component	R	0.0% (0.0%~400.0%)	An application parameter exclusive to belt machine.
0x2012 /0x3012	Torque filter time	R/W	0.000s (0.000s~6.000s)	Reads and writes the value of F03.47.
0x2013 /0x3013	Reserved	R/W	--	Use with option cards.
0x2014 /0x3014	Reserved	R/W	--	Use with option cards.
0x2015 /0x3015	Reserved	R/W	--	Use with option cards.
0x2016 /0x3016	Reserved	R/W	--	Use with option cards.
0x2017 /0x3017	Reserved	R/W	--	Use with option cards.
0x2018 /0x3018	Terminal output control	W	Binary	Output terminal function. Select F6.21 - F06.24 to be 30 [Communication control output]. Bit0: Y terminal Bit1: Relay Bit2: Extension Y1 Bit3: Extension relay
0x2019 /0x3019	AO output	W	0.01 (0~100.00)	F06.01=18 [AO function output selection = Set via RS485 communication].
0x201A /0x301A	Extension AO output	W	0.01 (0~100.00)	F06.11=18 [Extension AO function output selection = Set via RS485 communication].
0x201B /0x301B	Custom 1	R/W	0 (0~65535)	Used with an option card.
0x201C /0x301C	Custom 2	R/W	0 (0~65535)	Used with an option card.

0x201D /0x301D	Custom 3	R/W	0 (0~65535)	Used with an option card.
0x201E /0x301E	Custom 4	R/W	0 (0~65535)	Used with an option card.
0x201F /0x301F	Custom 5	R/W	0 (0~65535)	Used with an option card.

Option Card Communication Control Group (Address 0x31xx)

Communication Address	Name	Read/Write (R/W)	Dimension (Range)	Description
0x3100	Given frequency	R/W	0.01Hz (0.0Hz~600.00Hz)	Communication given frequency.
0x3101	Command setting	W	0x0000 (0x0000~0x0103)	0x0000: Invalid 0x0001: Forward running 0x0002: Reverse running 0x0003: Forward jogging 0x0004: Reverse jogging 0x0005: Deceleration stop 0x0006: Free stop 0x0007: Reset command 0x0008: Run prohibition command. If 8 is written to address 3001 via communication, the inverter will free stop. To allow the inverter to run again, write 9 to address 3001 or power it on again. 0x0009: Allow running command 0x0101: Equivalent to F02.07 = 1 [Rotation parameter Auto-tuning], plus the running command 0x0102: Equivalent to F05.07 = 2 [Static parameter Auto-tuning], plus the running command 0x0103: Equivalent to F05.07 = 3 [Stator resistance setting], plus the running command
0x3102	Inverter status information	R	Binary	Bit0: 0 - stop 1 - Run Bit1: 0 - Non-acceleration 1 - Acceleration Bit2: 0 - Non-deceleration 1 - Deceleration Bit3: 0 - Forward 1 - Reverse Bit4: 0 - Normal 1 - Faulty Bit5: 0 - Unlocked 1 - Locked Bit6: 0 - No warning 1 - Warning Bit7: 0 - Unable to run 1 - Able to run
0x3103	Inverter fault code	R	0 (0~127)	Communication reads the value of the fault code.
0x3104	Upper frequency limit	R/W	0.01Hz (0.0Hz~F01.10Hz)	The upper frequency limit is set via communication.
0x3105	Torque setting	R/W	0.0% (0.0%~100.0%)	The torque set point is set via communication.
0x3106	Torque control forward speed limit	R/W	0.0% (0.0%~100.0%)	The torque control forward speed limit is set via communication.
0x3107	Torque control reverse speed limit	R/W	0.0% (0.0%~100.0%)	The torque control reverse speed limit is set via communication.
0x3108	PID setting	R/W	0.0% (0.0%~100.0%)	The PID set point is set via communication.

0x3109	PID feedback	R/W	0.0% (0.0%~100.0%)	The PID feedback value is set via communication.
0x310A	VF separation voltage setting	R/W	0.0% (0.0%~100.0%)	An application parameter exclusive to inverter power supply.
0x310B	Tension setting	R/W	0.0% (0.0%~100.0%)	Unit-Specific Tension Parameter.
0x310C	Roll diameter setting	R/W	0.0% (0.0%~100.0%)	Unit-Specific Tension Parameter.
0x310D	Linear speed setting	R/W	0.0% (0.0%~100.0%)	Unit-Specific Tension Parameter.
0x310E	Acceleration time 1	R/W	0.00s (0.00s~600.00s)	Reads and writes the value of F01.22.
0x310F	Deceleration time 1	R/W	0.00s (0.00s~600.00s)	Reads and writes the value of F01.23.
0x3110	Fault warning & warning code	R	0 (0~65535)	1-127 are fault codes, 128-159 are warning codes, and 0 indicates no fault.
0x3111	Torque current component	R	0.0% (0.0%~400.0%)	An application parameter exclusive to belt machine.
0x3112	Torque filter time	R/W	0.000s (0.000s~6.000s)	Reads and writes the value of F03.47.
0x3113	Reserved	R/W	--	Use with option cards.
0x3114	Reserved	R/W	--	Use with option cards.
0x3115	Reserved	R/W	--	Use with option cards.
0x3116	Reserved	R/W	--	Use with option cards.
0x3117	Reserved	R/W	--	Use with option cards.
0x3118	Terminal output control	W	Binary	For output terminal function, set F06.21 - F06.24 to 30 [Communication control output]. Bit0: Y terminal Bit1: Relay Bit2: Expanded Y1 Bit3: Expanded relay
0x3119	AO output	W	0.01 (0~100.00)	F06.01 = 18 [AO function output selection = Set via RS485 communication].
0x311A	Expanded AO output	W	0.01 (0~100.00)	F06.11 = 18 [Expanded AO function output selection = Set via RS485 communication].
0x311B	Custom 1	R/W	0 (0~65535)	Used with an option card.
0x311C	Custom 2	R/W	0 (0~65535)	Used with an option card.
0x311D	Custom 3	R/W	0 (0~65535)	Used with an option card.
0x311E	Custom 4	R/W	0 (0~65535)	Used with an option card.
0x311F	Custom 5	R/W	0 (0~65535)	Used with an option card.

Input/Output Interface Communication Group (Address 0x34xx)

Communication Address	Name	Read/Write (R/W)	Dimension (Range)	Description
0x3400	Extension port SPI communication mode	R	0 (0~65535)	The default is 1 for AC310 series inverter.
0x3401	Input terminal status	R	Binary	Bit0: X1 Terminal 0-OFF 1-ON Bit1: X2 Terminal 0-OFF 1-ON Bit2: X3 Terminal 0-OFF 1-ON Bit3: X4 Terminal 0-OFF 1-ON Bit4: X5 Terminal 0-OFF 1-ON Bit5: X6 Terminal 0-OFF 1-ON Bit6: X7 Terminal 0-OFF 1-ON Bit7: X8 Terminal 0-OFF 1-ON Bit8: X9 Terminal 0-OFF 1-ON Bit9: X10 Terminal 0-OFF 1-ON
0x3402	Output terminal status	R	Binary	Bit0: Y terminal status 0-OFF 1-ON Bit1: Relay status 0-OFF 1-ON Bit2: Expanded Y1 status 0-OFF 1-ON Bit3: Expanded relay status 0-OFF 1-ON
0x3403	Reserved	R	--	--
0x3404	Reserved	R/W	--	--
0x3405	Multi-function input terminal functional group 0	R	Binary	For multi-function 0-15, each function corresponds to one bit. 0-OFF 1-ON
0x3406	Multi-function input terminal function group 1	R	Binary	For multi-function 16-31, each function corresponds to one bit. 0-OFF 1-ON
0x3407	Multi-function input terminal function group 2	R	Binary	For multi-function 32-47, each function corresponds to one bit. 0-OFF 1-ON
0x3408	Multi-function input terminal function group 3	R	Binary	For multi-function 48-63, each function corresponds to one bit. 0-OFF 1-ON
0x3409	Multi-function input terminal function group 4	R	Binary	For multi-function 64-79, each function corresponds to one bit. 0-OFF 1-ON
0x340A	Multi-function input terminal function group 5	R	Binary	For multi-function 80-95, each function corresponds to one bit. 0-OFF 1-ON

0x340B	IO extension card input terminal status	R	Binary	Bit0: X6 Terminal 0-OFF 1-ON Bit1: X7 Terminal 0-OFF 1-ON Bit2: X8 Terminal 0-OFF 1-ON Bit3: X9 Terminal 0-OFF 1-ON Bit4: X10 Terminal 0-OFF 1-ON Bit5 - Bit11 Reserved Bit12 - Bit15 correspond to 4-bit virtual terminal signals 0-OFF 1-ON
0x340C	IO extension card output terminal status	R	Binary	Bit0: Expanded Y1 status 0-OFF 1-ON Bit1: Expanded relay status 0-OFF 1-ON
0x340D	IO extension card analog 1	R	0.00% (0.00%~100.00%)	IO extension Card Analog Detection (Motor Temperature Detection).
0x340E	IO extension card analog 2	R	--	Reserved.
0x340F	IO extension card analog 3	R	--	Reserved.
0x3410	IO extension card analog 4	R	--	Reserved.
0x3411	IO extension card PUL frequency measurement 1	R	0 (0~65535)	extension Card PUL Frequency Measurement Value = PUL frequency measurement 1 + PUL frequency measurement 2*65535.
0x3412	IO extension card PUL frequency measurement 2	R	0 (0~65535)	
0x3413	Reserved	R/W	--	--
0x3414	A0 function 24 output	R/W	0 (0~1000)	Used with an option card.
0x3415	A0 function 25 output	R/W	0 (0~1000)	Used with an option card.
0x3416	A0 function 26 output	R/W	0 (0~1000)	Used with an option card.
0x3417	A0 function 27 output	R/W	0 (0~1000)	Used with an option card.
0x3418	A0 function 28 output	R/W	0 (0~1000)	Used with an option card.
0x3419	A0 function 29 output	R/W	0 (0~1000)	Used with an option card.
0x341A	A0 function 30 output	R/W	0 (0~1000)	Used with an option card.
0x341B	A0 function 31 output	R/W	0 (0~1000)	Used with an option card.
0x341C	IO extension card PUL port count 1	R	0 (0~65535)	Used with an option card.
0x341D	IO extension card PUL port count 2	R	0 (0~65535)	Used with an option card.
0x341E	Reserved	R/W	--	--

0x341F	Reserved	R/W	--	--
--------	----------	-----	----	----

Cache Register Communication Group (Address 0x35xx)

Communication Address	Name	Read/Write (R/W)	Dimension (Range)	Description
0x3500	Register 0	R/W	(0~65535)	Used with an option card.
0x3501	Register 1	R/W	(0~65535)	Used with an option card.
0x3502	Register 2	R/W	(0~65535)	Used with an option card.
0x3503	Register 3	R/W	(0~65535)	Used with an option card.
0x3504	Register 4	R/W	(0~65535)	Used with an option card.
0x3505	Register 5	R/W	(0~65535)	Used with an option card.
0x3506	Register 6	R/W	(0~65535)	Used with an option card.
0x3507	Register 7	R/W	(0~65535)	Used with an option card.
0x3508	Register 8	R/W	(0~65535)	Used with an option card.
0x3509	Register 9	R/W	(0~65535)	Used with an option card.
0x350A	Register 10	R/W	(0~65535)	Used with an option card.
0x350B	Register 11	R/W	(0~65535)	Used with an option card.
0x350C	Register 12	R/W	(0~65535)	Used with an option card.
0x350D	Register 13	R/W	(0~65535)	Used with an option card.
0x350E	Register 14	R/W	(0~65535)	Used with an option card.
0x350F	Register 15	R/W	(0~65535)	Used with an option card.

Extension Fault and Power-Off Parameter Communication Group (Address 0x36xx)

Communication Address	Name	Read/Write (R/W)	Dimension (Range)	Description
0x3600	Custom fault number register	R/W	0 (11~18)	11-18 correspond to faults E. FA1-E. FA8.
0x3601	Custom early-warning number register	R/W	0 (11~16)	11 to 16 correspond to warnings A. FA1-A. FA6.
0x3602	Reserved	R/W	--	--
0x3603	Reserved	R/W	--	--
0x3604	Reserved	R/W	--	--
0x3605	Reserved	R/W	--	--
0x3606	Reserved	R/W	--	--
0x3607	Reserved	R/W	--	--
0x3608	Reserved	R/W	--	--
0x3609	Reserved	R/W	--	--
0x360A	Stored parameter 1 after power-off	R/W	(0~65535)	Used with an option card. Check with C02.32.
0x360B	Stored parameter 2 after power-off	R/W	(0~65535)	Used with an option card. Check with C02.33.

0x360C	Stored parameter 3 after power-off	R/W	(0~65535)	Used with an option card. Check with C02.34.
0x360D	Stored parameter 4 after power-off	R/W	(0~65535)	Used with an option card. Check with C02.35.
0x360E	Stored parameter 5 after power-off	R/W	(0~65535)	Used with an option card. Check with C02.36.
0x360F	Stored parameter 1 after power-off	R/W	(0~65535)	Used with an option card. Check with C02.37.
0x3610	Stored parameter 6 after power-off	R/W	(0~65535)	Used with an option card. Check with C02.38.
0x3611	Stored parameter 7 after power-off	R/W	(0~65535)	Used with an option card. Check with C02.39.
0x3612	Stored parameter 8 after power-off	R/W	(0~65535)	Used with an option card. Check with C02.40.
0x3613	Stored parameter 9 after power-off	R/W	(0~65535)	Used with an option card. Check with C02.41.
0x3614	Stored parameter 10 after power-off	R/W	(0~65535)	Used with an option card. Check with C02.42.
0x3615	Stored parameter 11 after power-off	R/W	(0~65535)	Used with an option card. Check with C02.43.
0x3616	Stored parameter 12 after power-off	R/W	(0~65535)	Used with an option card. Check with C02.44.
0x3617	Stored parameter 13 after power-off	R/W	(0~65535)	Used with an option card. Check with C02.45.
0x3618	Stored parameter 14 after power-off	R/W	(0~65535)	Used with an option card. Check with C02.46.
0x3619	Stored parameter 15 after power-off	R/W	(0~65535)	Used with an option card. Check with C02.47.

0x361A	Reserved	R/W	--	-
0x361B	Reserved	R/W	--	--
0x361C	Reserved	R/W	--	-
0x361D	Reserved	R/W	--	--
0x361E	Reserved	R/W	--	-
0x361F	Reserved	R/W	--	--

Chapter 6 Parameter details

6.1 Safety Precautions

Danger

Please follow all the safety instructions in this manual.

Failure to follow the precautions may result in death or serious injury. Please be cautious. We will not take any responsibility for personal injuries and equipment damages caused by your company or your customers due to not complying with the contents of this Manual.

6.2 Group F00: Environmental Application

Group F00 parameters [Environment application] are used to set items related to the operating environment of the inverter.

Group F00.0x: Environment Settings

Group F00 parameters are used to set the operating environment and operating conditions for frequency conversion. Examples are parameter access levels, purpose selection and other items.

◇ F00.00: Parameter Access Level

Parameter Code (Address)	Name	Description	Default (Range)
F00.00 (0x0000) RUN	Parameter access level	V/F SVC FVC PMVF PMSVC PMFVC Set the parameter access level according to the parameter access limitations.	0 (0~3)

0: Standard Parameter

Allows access to parameter groups (Fxx groups) and monitoring parameter (Cxx groups).

1: Common parameter (F00.00, Pxx.yy)

Allows access only to the parameter codes set in F00.00 parameters and F00.10 - F00.39 [Common parameters 1-30].

2: Monitoring parameter (F00.00, Cxx.yy)

Allows access only to F00.00 parameters and monitoring group parameters.

3: Parameter changed (F00.00, Hxx.yy)

Allows access only to F00.00 parameters, and parameters different from the Defaults.

Note:

When a lock password has been set for the inverter with F11.00 [Key lock selection] and F11.01 [Key lock password], the Keypad cannot be used to change the corresponding parameters.

◇ F00.01: Purpose Selection

Parameter Code (Address)	Name	Description	Default (Range)
F00.01 (0x0001) STOP	Use selection	V/F SVC FVC PMVF PMSVC PMFVC Set the inverter for the intended use.	0 (0~1)

This inverter has the special preset settings for the uses as shown in the table below. After F00.01 is set for the intended use, the inverter will automatically set the parameters related to the use to the optimal values. Parameters to be changed frequently are saved in F00.10 - F00.39 [Common parameters 1-30] for quick setting and viewing.

0: General purpose unit (G model)

1: Fan and water pump model (P model)

Note:

After setting F00.01, initialize the parameters with F00.03 = 11, 22 [Initialization = Initialization mode 1, 2]. F00.30 - F00.39 will be reset after the parameterization and initialization.

The following are values of commonly used parameter codes after initialization.

Table 11.1: Values of commonly used parameter codes after initialization

Common Parameter Code	Set Point	Parameter Code Corresponding To Set Point	Name
F00.10	0100	F01.00	Control mode selection.
F00.11	0101	F01.01	Run command given channel.
F00.12	0102	F01.02	Frequency given channel.
F00.13	0710	F07.10	Stop mode.
F00.14	0122	F01.22	Acceleration time 1.
F00.15	0123	F01.23	Deceleration time 1.
F00.16	0110	F01.10	Maximum frequency.
F00.17	0112	F01.12	Upper frequency limit.
F00.18	0140	F01.40	Carrier frequency.
F00.19	0730	F07.30	Jogging frequency.
F00.20	0201	F02.01	Poles of motor.
F00.21	0202	F02.02	Rated power of motor.
F00.22	0203	F02.03	Rated frequency of motor.
F00.23	0204	F02.04	Rated speed of motor.
F00.24	0205	F02.05	Rated voltage of motor.
F00.25	0206	F02.06	Rated current of motor.
F00.26	0207	F02.07	Selection of motor parameter Auto-tuning.
F00.27	1201	F12.01	Modbus communication address.
F00.28	1202	F12.02	Communication baud rate.
F00.29	1203	F12.03	Communication data format.

The values of the following common parameter codes after initialization are related to the F00.01 setting.

0: General purpose unit (G model)

Table 11.2: Values of commonly used parameter codes after initialization

Common Parameter Code	Set Point	Parameter Code Corresponding To Set Point	Name
F00.30	0700	F07.00	Startup mode.
F00.31	0705	F07.05	Rotation direction selection.
F00.32	0502	F05.02	X3 terminal function selection.
F00.33	0503	F05.03	X4 terminal function selection.
F00.34	0504	F05.04	X5 terminal function selection.
F00.35	0601	F06.01	AO output selection.
F00.36	0600	F06.00	AO output mode selection.
F00.37	0621	F06.21	Output terminal y function selection.

F00.38	0622	F06.22	TA-TB-TC output function selection.
F00.39	0400	F04.00	V/f curve.

1: Fan and water pump model (P model)

Table 11.3: Values of commonly used parameter codes after initialization

Common Parameter Code	Set Point	Parameter Code Corresponding to Set Point	Name
F00.30	0700	F07.00	Startup mode.
F00.31	0705	F07.05	Rotation direction selection.
F00.32	0400	F04.00	V/F curve.
F00.33	1050	F10.50	Number of retries after fault.
F00.34	1300	F13.00	PID setting.
F00.35	1303	F13.03	PID feedback.
F00.36	1307	F13.07	PID control selection.
F00.37	1311	F13.11	PID proportional gain P1.
F00.38	1325	F13.25	PID feedback disconnection selection.
F00.39	1329	F13.29	Sleep selection.

◇ F00.03: Initialization

Parameter Code (Address)	Name	Description	Default (Range)
F00.03 (0x0003) STOP	Initialization	V/F SVC FVC PMVF PMSVC PMFVC Sets the initialization mode of the inverter.	0 (0~33)

Note: The value of F00.03 automatically returns to zero after initialization.

0: No initialization.

11: Initialization Mode 1

Restores all parameters except F02.01 - F02.06 [Basic motor parameters], F02.10 - F02.29 [Advanced motor parameters] and parameters that cannot be initialized.

22: Initialization Mode 2

Recovers all parameters except those that cannot be initialized.

33: Clear fault records

Clears all historical fault information recorded in monitoring parameter group C01.

The following parameters will not be initialized even if F00.03 = 11 or 22.

Parameter Code	Name
F00.10~F00.29	Common parameters 1-20.
F00.01	Purpose selection.
F07.05	Rotation direction selection.
F11.05	Parameter code setting quick change with up/down key.
F11.11~F11.18	Parameters displayed repeatedly in keypad status screen.
F12.11~F12.16	RS485 custom address setting.

Note:

- F00.03 = 11 or 22. F00.30 - F00.39 are set to different values after initialization according to F00.01 [Purpose selection].

◇ F00.04: Keypad Parameter Copy

Parameter Code (Address)	Name	Description	Default (Range)
F00.04 (0x0004) STOP	Keypad parameter copy	V/F SVC FVC PMVF PMSVC PMFVC Saves the parameters of the inverter into the keypad for copying them to another inverter later.	0 (0~30)

0: No action

11: Upload parameters to the keypad

Reads the set values of parameters from the inverter and save them into the Keypad.

22: Download parameters to the inverter

Copies the set values of parameters saved in the Keypad to another inverter.

The action mode will be displayed on the Keypad when the parameter values are being copied.

Keypad display	Name
CoPy	Uploads parameters to the Keypad.
LoAd	Downloads the parameters to the inverter.

If a fault is detected, the fault will be displayed on the keypad when the parameter values are being copied.

Code	Name	Cause	Countermeasures
A.CoP	Parameter copy abnormality alarm	Abnormal communication occurs during the copying process.	Check or replace the Keypad cable.

◇ F00.07 - F00.08: Arbitrary Parameters

Parameter Code (Address)	Name	Description	Default (Range)
F00.07 (0x0007) RUN	Free parameter 1	V/F SVC FVC PMVF PMSVC PMFVC You may enter any value as a flag.	0 (0~65535)
F00.08 (0x0008) RUN	Free parameter 2	V/F SVC FVC PMVF PMSVC PMFVC You may enter any value as a flag.	0 (0~65535)

Note: Arbitrary parameters will not affect the motion of inverter.

For example:

- Serves as the unit number when multiple units are used.
- Serves as the mode number for each use when multiple units are used.
- Dates of purchase, check, etc.

Group F00.1x: Common Parameter Settings

◇ F00.10~F00.39: Common Parameters 1-30

Parameter Code (Address)	Name	Description	Default (Range)
F00.10~F00.29 (0x000A~0x001D) RUN	Common parameters 1-20	V/F SVC FVC PMVF PMSVC PMFVC It is possible to register 20 commonly used parameters in F00.10 - F00.29, and the registered parameters can be accessed quickly by setting F00.00 [Parameter access level].	General Default Parameters (0000-2999)
F00.30~F00.39 (0x001E~0x0027) RUN	Common parameters 21-30	V/F SVC FVC PMVF PMSVC PMFVC It is possible to register 10 commonly used parameters in F00.30 - F00.39, and the registered parameters can be accessed quickly by setting F00.00 [Parameter access level].	Depending on F00.01 (0000-2999)

Note:

- F00.03 = 11 or 22. F00.30 - F00.39 are set to different values after initialization according to F00.01 [Purpose selection].
- Common parameters can be accessed quickly by setting F00.00=1 [Parameter access level = Common parameters].

6.3 Group F01: Basic Settings

Group F01.0x: Basic Commands

Group F01.0x parameters are used to set the control mode, run command source and frequency setting source.

Control Mode

◇ F01.00: Control Mode

Parameter Code (Address)	Name	Description	Default (Range)
F01.00 (0x0100) STOP	Control mode	V/F SVC FVC PMVF PMSVC PMFVC Selects the control mode according to the type and intended use of the motor.	0 (0~20)

Selects the control mode according to the type and intended use of the motor.

0: Asynchronous Motor V/F Control (V/F)

This control mode is used for variable speed control that do not require fast response or accurate speed control, and in scenarios where one inverter is used with multiple motors. This mode is also used when the motor parameters are not clear or Auto-tuning cannot be performed.

1: Asynchronous Motor Open-Loop Vector Control (SVC)

This control mode is used for applications requiring high speed control accuracy. With high speed response and torque response, high torque can be output even under low-speed running.

2: Asynchronous Motor Closed-Loop Vector Control (FVC)

This control mode is used in scenarios requiring fast torque response and high-precision speed control before zero speed is reached. Feedback signals from motor speed is required.

10: Synchronous Motor V/F control (PMV/F)

This control mode is used for variable speed control of synchronous motors that do not require fast response or accurate speed control.

11: Synchronous Motor Open-Loop Vector Control (PMSVC)

This control mode is used for applications that require precise speed control and torque limit functions.

12: Synchronous Motor Closed-Loop Vector Control (PMFVC)

This control mode is used for constant torque applications requiring high-precision control when using PM motors, and variable speed control requiring fast torque response and high-performance torque control. Speed feedback from the motor is required.

20: Voltage-Frequency separation Control (VF_separation)

This control mode is used to control the output voltage and frequency separately. (Valid only for T3 models of 7.5 kW or above and T2 models of 5.5 kW and above).

Note:

- In order to obtain the best control effect, please input the correct motor parameters and perform motor Auto-tuning. Group F02.0x is the basic parameter group of the motor.
- In open-loop and closed-loop vector control, the inverter can only drive one motor; and there shall not be too large discrepancy between the level of inverter capacity and that of motor capacity. The power level of inverter can be two levels higher or one level lower than that of the motor, otherwise it may cause degraded control performance or failure of drive system.

Run Command Source

◇ F01.01: Run Command Channel

Parameter Code (Address)	Name	Description	Default (Range)
F01.01 (0x0101) RUN	Run command channel	V/F SVC FVC PMVF PMSVC PMFVC Selects the input method for run commands.	0 (0~3)

0: Keypad

Uses the Keypad to control the operation and stop of the inverter.

The functions of multi-function keys can be set with F11.02 = 1, 2, 3 [Keypad multi-function key selection = reverse rotation, forward jogging, reverse jogging] to control the reverse rotation, forward jogging and reverse jogging of the inverter.

1: Terminal Control

Controls the operation and stop of the inverter with the terminals on the control board. The input method of run commands is selected with parameters. Please set F05.20 = 0-3 [Terminal controlled operation mode = 2-wire system 1, 2; 3-wire system 1, 2].

2: RS485 Communication

Run commands are input via RS485 communication.

3: Option card

An optional communication card or input card plugged into the inverter is used to input run commands.

Refer to the instructions supplied together with the option cards for information on the installation and relevant settings of the option cards.

3: Terminal switching command given

Command Input Mode		Priority	Description
Jogging	Jogging with keypad	2	Effective when the run command channel is Keypad.
	Jogging via RS485 communication	2	Effective when the run command channel is RS485 communication.
	Jogging with option card	2	Effective when the run command channel is option card.
	Jogging with terminals	3	Effective with any channel.
Run command channel		1	Set with parameter F01.01.

Table 11.4: Command input selection mode

Note: The higher the priority value, the higher the priority.

Frequency Setting

The input method, selection and priority of frequency commands are explained.

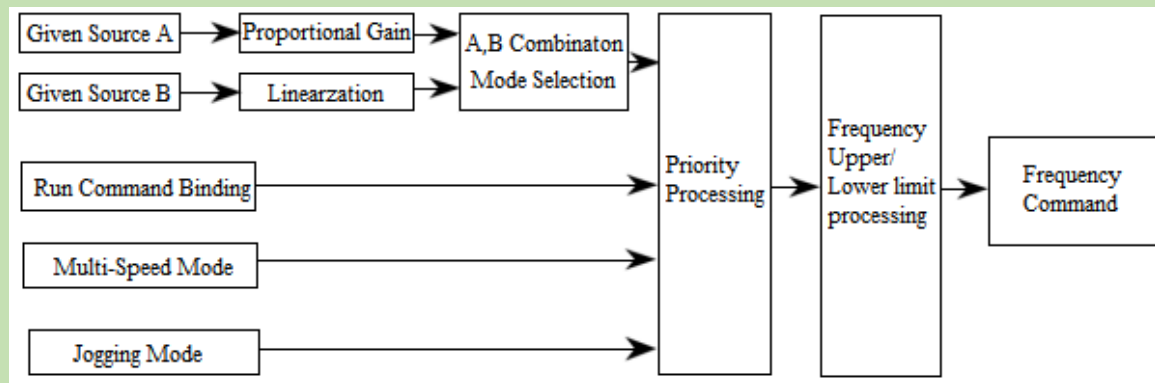

Diagram of Frequency Command Setting

Table 11.5: Frequency input selection mode

Frequency Input Mode		Priority	Description
Given source mode	Given source A	1	Input from given source A. The related parameters are F01.02 and F01.03.
	Given source B	1	Input from given source B. The related parameters are F01.04, F01.05 and F01.06.
	Given sources A and B	1	With F01.07, given sources A and B are combined to set the frequency.
Mode of frequency setting with run command binding		2	Bound frequency setting with command channel set with F01.08.
Multi-speed mode		3	The frequency is set by setting the multi-function terminal to multi-speed selection.
Jogging mode		4	When the jogging command is effective, the jogging frequency is set with F07.30.

Note:

1. The higher the priority value, the higher the priority.
2. The priority of the multi-speed mode is that shown in the table above only when there is no multi-speed selection among the setting source modes.
3. The priority of the multi-speed selection mode is the same as that of other modes among the set sources when multi-speed selection exists among the setting source modes.

Methods for modes of frequency setting sources A and B and frequency setting with run command binding:

Input method for frequency setting sources	Description
Set with keypad digital	The set point of F01.09 is set as the frequency.
Set with keypad potentiometer	This method is used when an outer single-line Keypad is used. The linearized values of 0% - 100% of the potentiometer correspond to 0 Hz - maximum frequency.
Set with AI1	Linearized values of 0% - 100% of the AI1 input corresponds to 0 Hz - maximum frequency.
Set with AI2	Linearized values of 0% - 100% of the AI2 input corresponds to 0 Hz - maximum frequency.
Terminal pulse PUL	Linearized values of 0% - 100% of the PUL input corresponds to 0 Hz - maximum frequency.
RS485 communication	The value is written to the address 0x3000 via RS485 communication to set the frequency value.
Terminal up/down button control	F05.25 and F05.26 are used to set the control mode of the up and down keys of terminals and the increase and decrease rates.
PID control	The values of 0% - 100% of process PID control output of group F13 correspond to 0 Hz - maximum frequency.
PLC program control	The frequency of each stage in group F14 group program control is used as the set frequency.
Option card	The set frequency value is obtained via communication with an option card.
Multi-speed	The frequency of the corresponding stage is determined to be the set frequency by setting the multi-function terminal to multi-speed.

Note:

1. Refer to the instructions of the option card for details on the option card's communication address for setting frequency.
2. The reference value of frequency setting source B is selected with F01.06 = 0, 1 [Reference value of frequency setting source B = Maximum frequency, setting source A]
3. The maximum frequency is set with F01.10.

Multi-Speed Operation:

The inverter supports multi-speed operation, and multiple frequency commands can be preset as necessary. A number of frequency command values can be set in parameters F14.00 to F14.14, and the frequency setting command is selected in combination with multi-function input signals from the outside. The frequency command required for ON/OFF selection of connector input can be used to change the motor speed by stage. It is possible to have 17 speeds with 16 stages of frequency commands and 1 jogging frequency command (JOG command).

The combinations of multi-speed commands are shown in the table below.

Table 11.6 Combinations of Multi-Speed Commands and Multi-Function Connector Input Terminals

Related Parameters	Multi-Speed Terminal 1 F05.0x = 16	Multi-Speed Terminal 2 F05.0x = 17	Multi-Speed Terminal 3 F05.0x = 18	Multi-Speed Terminal 4 F05.0x = 19	Jogging Terminal F05.0x = 4/5
F01.09 Set with keypad digital	OFF	OFF	OFF	OFF	OFF
F14.00 Multi-Speed 1	ON	OFF	OFF	OFF	OFF
F14.01 Multi-Speed 2	OFF	ON	OFF	OFF	OFF
F14.02 Multi-Speed 3	ON	ON	OFF	OFF	OFF
F14.03 Multi-Speed 4	OFF	OFF	ON	OFF	OFF
F14.04 Multi-Speed 5	ON	OFF	ON	OFF	OFF
F14.05 Multi-Speed 6	OFF	ON	ON	OFF	OFF

F14.06 Multi-Speed 7	ON	ON	ON	OFF	OFF
F14.07 Multi-Speed 8	OFF	OFF	OFF	ON	OFF
F14.08 Multi-Speed 9	ON	OFF	OFF	ON	OFF
F14.09 Multi-Speed 10	OFF	ON	OFF	ON	OFF
F14.10 Multi-Speed 11	ON	ON	OFF	ON	OFF
F14.11 Multi-Speed 12	OFF	OFF	ON	ON	OFF
F14.12 Multi-Speed 13	ON	OFF	ON	ON	OFF
F14.13 Multi-Speed 14	OFF	ON	ON	ON	OFF
F14.14 Multi-Speed 15	ON	ON	ON	ON	OFF
F07.30 Jogging Frequency	-	-	-	-	ON

◇ **F01.02 - F01.03: Frequency given source channel A**

Parameter Code (Address)	Name	Description	Default (Range)
F01.02 (0x0102) RUN	Frequency given source channel A	V/F SVC FVC PMVF PMSVC PMFVC Selects the input mode for frequency setting.	0 (0~11)
F01.03 (0x0103) STOP	Gain of frequency given source channel A	V/F SVC FVC PMVF PMSVC PMFVC Performs proportional gain processing on the value input from setting source A.	100.0% (0.0%~500.0%)

Frequency given source channel A Output Mode:

- 0: Keypad digital
- 1: Keypad potentiometer (optional outer single-line keypad)
- 2: Current/voltage analog AI1
- 3: Current/voltage analog AI2
- 4: Reserved
- 5: Terminal pulse PUL
- 6: RS485 communication
- 7: Terminal UP/DW control
- 8: PID control
- 9: Program control (PLC)
- 10: Option card
- 11: Multi-speed

◇ **F01.04 - F01.06: Frequency given source channel B**

Parameter Code (Address)	Name	Description	Default (Range)
F01.04 (0x0102) RUN	Frequency given source channel B	V/F SVC FVC PMVF PMSVC PMFVC Selects the input mode for frequency setting.	2 (0~11)
F01.05 (0x0103) STOP	Gain of frequency given source channel B	V/F SVC FVC PMVF PMSVC PMFVC Performs proportional gain processing on the value input from setting source B.	100.0% (0.0%~500.0%)
F01.06 (0x0106) RUN	Frequency given source B reference value	V/F SVC FVC PMVF PMSVC PMFVC The value input from setting source B is linearized, and the input value is the value corresponding to 100%.	0 (0~1)

Frequency given source channel B Output Mode:

- 0: Keypad digital
- 1: Keypad potentiometer (optional outer single-line keypad)
- 2: Current/voltage analog AI1
- 3: Current/voltage analog AI2
- 4: Reserved
- 5: Terminal pulse PUL
- 6: RS485 communication
- 7: Terminal UP/DW control
- 8: PID control
- 9: Program control (PLC)
- 10: Option card
- 11: Multi-speed

Frequency given source channel B Reference Value:

- 0: F01.10 [Maximum frequency] as reference source
- 1: Frequency set with frequency given source A as the reference source

◇ **F01.07: Frequency given source selection**

Parameter Code (Address)	Name	Description	Default (Range)
F01.07 (0x0107) RUN	Frequency given source selection	V/F SVC FVC PMVF PMSVC PMFVC Sets the combination of frequency set sources A and B.	0 (0~5)

0: Frequency given source A

1: Frequency given source B

2: Sum of frequency given source A and frequency given source B

3: Difference between frequency given source A and frequency given source B (A - B)

4: Frequency given source A or frequency given source B, whichever the larger

5: Frequency given source A or frequency given source B, whichever the smaller

Note:

- The value of the combination is subject to the upper and lower frequency limits.
 - If the LED"00" of F07.05 = 1 [Running direction = Only forward command is allowed] or the LED"000" of F07.05 = 0 [Frequency control command direction = Invalid], 0.00 Hz is used as the set frequency of the inverter when the calculation result of combination is negative.
- ◇ **F01.08: Frequency Given with Run Command Binding**

Parameter Code (Address)	Name	Description	Default (Range)
F01.08 (0x0108) RUN	Frequency given with run command binding	V/F SVC FVC PMVF PMSVC PMFVC Sets the method for frequency setting with run command binding.	0000 (0000~DDDD)

Note: The set point is expressed in hexadecimal. Each of the places of LED"0",LED"00", LED"000" and LED"0000" has a different meaning.

0: No binding

1: Keypad digital

2: Keypad potentiometer (optional outer single-line keypad)

3: Current/voltage analog AI1

4: Current/voltage analog AI2

5: Reserved

6: Terminal pulse PUL

7: RS485 communication

8: Terminal UP/DW control

9: PID control

A: Program control (PLC)

B: Option card

C: Multi-speed

D: Reserved

LED"0": Keypad command binding

LED"00": Terminal command binding

LED"000": Communication instruction command binding

LED"0000": Option card instruction command binding

In an example of frequency setting with run command binding, remote/local switching is used. For the remote mode, setting via communication commands and frequency setting are used; for the local mode, setting with terminal commands and keypad digital are used. Just switch the command setting method with the terminal, and then set the mode of frequency setting with run command binding for different channels.

◇ **F01.09: Keypad Number Set Frequency**

Parameter Code (Address)	Name	Description	Default (Range)
F01.09 (0x0109) RUN	Keypad number set frequency	V/F SVC FVC PMVF PMSVC PMFVC Sets frequency setting with keypad digital.	50.00Hz (0.00Hz~F01.12)

Note:

- This parameter is effective when F01.02 = 0 [Frequency setting source A = Set with keypad digital] or F01.04 = 0 [Frequency setting source B = Set with keypad digital].

Group F01.1x: Upper and Lower Frequency Limits

Group F01.1x parameters are used to set the upper and lower limits of frequency commands to limit the speed of motor. For example, they may be used when high-speed operation is not desired due to mechanical strength, or when low-speed operation is not desired due to lubrication of gears, bearings, etc.

The upper limit value of frequency is selected with F01.11 [Upper frequency limit setting mode selection], and the lower limit value is set with F01.13 [Lower frequency limit].

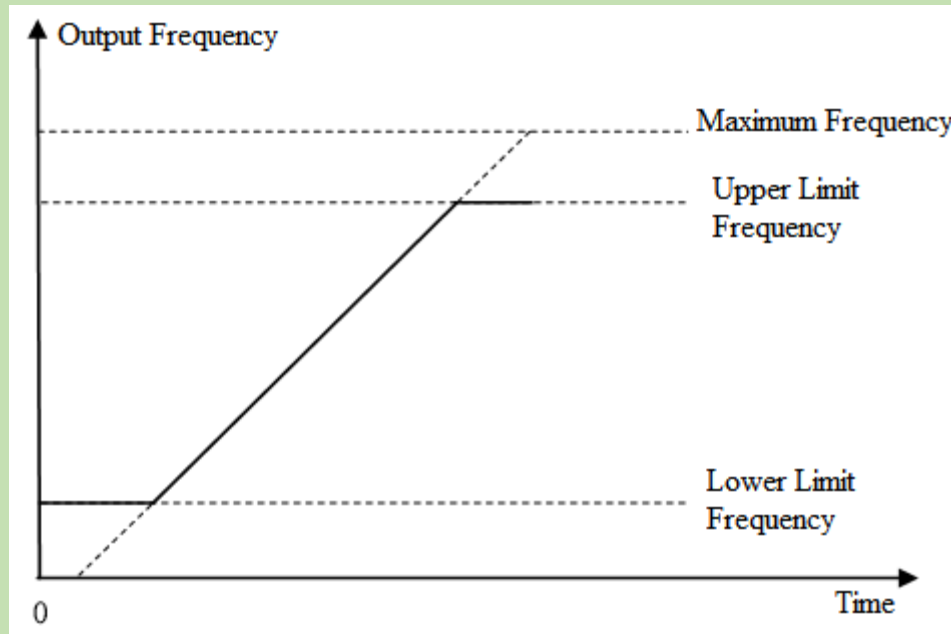

Diagram of Relationship between Maximum Frequency, Upper Frequency Limit and Lower Frequency Limit

◇ F01.10: Maximum Frequency

Parameter Code (Address)	Name	Description	Default (Range)
F01.10 (0x010A) STOP	Maximum frequency	V/F SVC FVC PMVF PMSVC PMFVC Sets the maximum frequency value.	50.00 Hz (Upper frequency limit - 500.00 Hz)

The maximum frequency is used as the reference corresponding to 100.0% when analog input, pulse input (PUL), PID control output and other numerical values in the inverter are converted into frequency;

The maximum frequency is used as the reference frequency for acceleration/deceleration time (F01.20 = 0 [Acceleration/Deceleration time reference frequency = Maximum frequency]).

◇ F01.11 - F01.12: Upper Frequency Limit

Parameter Code (Address)	Name	Description	Default (Range)
F01.11 (0x010B) RUN	Upper Frequency Limit Setting Mode Selection	V/F SVC FVC PMVF PMSVC PMFVC Upper Frequency Limit Setting Mode Selection.	0 (0~7)
F01.12 (0x010C) RUN	Upper frequency limit setting with numbers	V/F SVC FVC PMVF PMSVC PMFVC Sets the upper frequency limit value.	50.00 Hz (Lower frequency limit - F01.10)

The upper frequency limit sets the maximum value of the calculated frequency of a frequency setting source. If the calculated frequency is greater than the upper frequency limit, the upper frequency limit is taken as the set frequency.

0: Sets Upper Frequency Limit with Numbers

1: Keypad potentiometer (optional outer single-line Keypad)

2: Current/voltage analog AI1

3: Current/voltage analog AI2

4: Reserved

5: Terminal pulse PUL

6: RS485 communication

7: Option card

◇ **F01.13: Lower Frequency Limit**

Parameter Code (Address)	Name	Description	Default (Range)
F01.13 (0x010D) RUN	Lower Frequency Limit	V/F SVC FVC PMVF PMSVC PMFVC Sets the lower frequency limit value.	0.00 Hz (0.00 Hz - upper frequency limit)

The lower frequency limit sets the minimum value of the calculated frequency of a frequency setting source. If the calculated frequency is smaller than the lower frequency limit, the lower frequency limit is taken as the set frequency.

Note:

- The jogging frequency setting is not subject to the lower frequency limit.

◇ **F01.14: Frequency Command Resolution**

Parameter Code (Address)	Name	Description	Default (Range)
F01.14 (0x010E) STOP	Frequency Command Resolution	V/F SVC FVC PMVF PMSVC PMFVC Sets the resolution of frequency commands.	0 (0~3)

Resolution options:

0: 0.01Hz

1: 0.1Hz

2: 0.1rpm

3: 1rpm

Note:

- After the frequency command resolution is switched, the function code resolution related to frequency will also be switched.

Group F01.2x~F01.3x: Acceleration/Deceleration Time

Acceleration/Deceleration Time 1 - 4

Up to 4 pairs of acceleration/deceleration time can be set for the product. The acceleration/deceleration time may be switched even during operation by turning ON/OFF the multi-function input terminals for which Acceleration/Deceleration Time Selection 1 and Acceleration/Deceleration Time Selection 2 has been set.

Sets the acceleration time of the output frequency from 0Hz to the reference frequency for acceleration/deceleration time. Sets the deceleration time of the output frequency from the reference frequency for acceleration/deceleration time to 0Hz.

F01.22 [Acceleration Time 1] and F01.23 [Deceleration Time 1] are Valid by default.

The reference frequency for acceleration/deceleration time is selected with F01.20 [Selection of reference frequency for acceleration/deceleration time]

F01.20 Set Point	Description
0	The maximum frequency is taken as the reference frequency.
1	The fixed frequency of 50.00 Hz is taken as the reference frequency.
2	The set frequency is taken as the reference frequency.

The setting range of acceleration/deceleration time is selected with F01.21 [Unit of acceleration/deceleration time]

Parameter	Set Range		
	F01.21 = 0	F01.21 = 1	F01.21 = 2
F01.22 [Acceleration Time 1]	0s~65000s	0.0s~6500.0s	0.00s~650.00s
F01.23 [Deceleration Time 1]			
F01.24 [Acceleration Time 2]			
F01.25 [Deceleration Time 2]			
F01.26 [Acceleration Time 3]			
F01.27 [Deceleration Time 3]			
F01.28 [Acceleration Time 4]			
F01.29 [Deceleration Time 4]			

The acceleration/deceleration time is switched with instructions of the multi-function input terminals

The combinations of acceleration/deceleration time switching are shown in the table below.

Table 11.7: Acceleration/Deceleration time switched with terminals

F05.0x = 32 Acceleration/Deceleration Time Selection 1	F05.0x = 33 Acceleration/Deceleration Time Selection 2	Acceleration/Deceleration Time Selection	
		Acceleration Time	Deceleration Time
OFF	OFF	F01.22 [Acceleration Time 1]	F01.23 [Deceleration Time 1]
ON	OFF	F01.24 [Acceleration Time 2]	F01.25 [Deceleration Time 2]
OFF	ON	F01.26 [Acceleration Time 3]	F01.27 [Deceleration Time 3]
ON	ON	F01.28 [Acceleration Time 4]	F01.29 [Deceleration Time 4]

An example of operation after changing the acceleration/deceleration time is shown in the figure below. In this example, F07.10 = 0 [Stop Method Selection = Deceleration to stop].

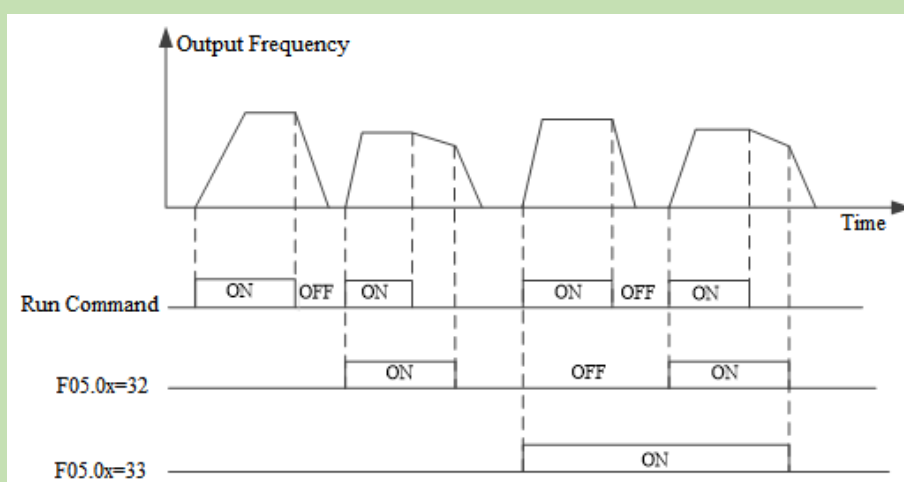

Time Sequence Diagram of Acceleration/Deceleration Time

The acceleration/deceleration time is switched with output frequency

The acceleration/deceleration time of the inverter can be automatically switched according to the set output frequency. The acceleration/deceleration time of the inverter is automatically switched when the output frequency reaches the set point of F01.35 [Acceleration/Deceleration Time Switching Frequency]. This function is disabled when F01.35 = 0.00 Hz.

Note:

The acceleration/deceleration time selection function set on the multi-function input takes precedence over the automatic acceleration/deceleration time switching function set with F01.35. For example, when the multi-function input terminal for acceleration/deceleration time selection 1 [F05.0x = 32] is set to ON, the inverter only uses Acceleration/Deceleration Time 2, and the automatic switching function of acceleration/deceleration time with F01.35 is disabled.

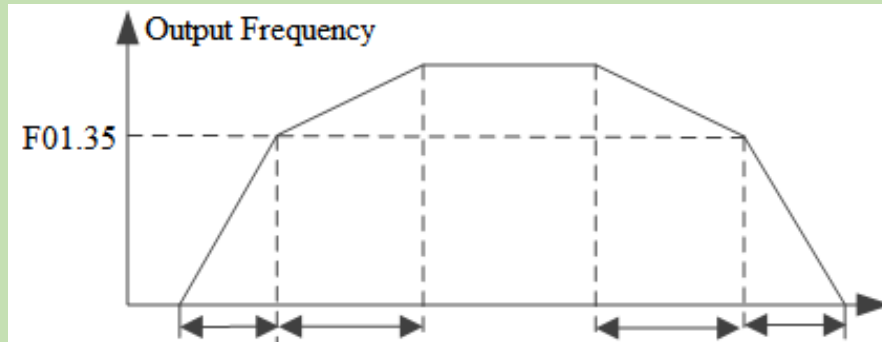

Note: Acceleration/Deceleration Time 1 is used when the output frequency is less than or equal to F01.35; Acceleration/Deceleration Time 2 is used when the output frequency is larger than or equal to F01.35.

◇ **F01.20: Reference Frequency for Acceleration/Deceleration Time**

Parameter Code (Address)	Name	Description	Default (Range)
F01.20 (0x0114) STOP	Reference frequency for acceleration/deceleration time	V/F SVC FVC PMVF PMSVC PMFVC Set the reference frequency for acceleration/deceleration time.	0 (0~3)

0: Maximum frequency The reference for acceleration/deceleration time is F01.10 [Maximum frequency].

1: Fixed frequency The reference for acceleration/deceleration time is fixed at 50.00 Hz.

2: Given frequency The reference for acceleration/deceleration time is the given frequency. Please note that the acceleration of the motor will change if the given frequency changes frequently.

◇ **F01.21: Acceleration/Deceleration Time Range Selection**

Parameter Code (Address)	Name	Description	Default (Range)
F01.21 (0x0115) STOP	Acceleration/Deceleration Time Range Selection	V/F SVC FVC PMVF PMSVC PMFVC Sets the decimal point of F01.22 - F01.29 [Acceleration/Deceleration time 1 to 4] parameters.	2 (0~2)

Note: The Default is 2, which means two decimal digits.

0: No decimal point

1: 1 decimal digit

2: 2 decimal digits◇ **F01.22: Acceleration Time 1**

Parameter Code (Address)	Name	Description	Default (Range)
F01.22 (0x0116) RUN	Acceleration time 1	V/F SVC FVC PMVF PMSVC PMFVC Set the value of acceleration time 1.	Depending on power level (Changing with F01.21)

◇ **F01.23: Deceleration Time 1**

Parameter Code (Address)	Name	Description	Default (Range)
F01.23 (0x0117) RUN	Deceleration time 1	V/F SVC FVC PMVF PMSVC PMFVC Set the value of deceleration time 1.	Depending on power level (Changing with F01.21)

The relationship between the Default of acceleration/deceleration time and the power level of the inverter is shown in the table below.

Inverter Power	Defaults of Acceleration/Deceleration Time 1 - 4
<22kW	6.00s
<45kW	12.00s
<=55kW	18.00s
<=75kW	24.00s
<=90kW	30.00s
<=132kW	36.00s
<=160kW	42.00s
<185kW	48.00s
<220kW	54.00s
Others	60.00s

◇ **F01.24~F01.25 Acceleration/Deceleration Time 2**

Parameter Code (Address)	Name	Description	Default (Range)
F01.24 (0x0118) RUN	Acceleration time 2	V/F SVC FVC PMVF PMSVC PMFVC Set the value of acceleration time 2.	Depending on power level (Changing with F01.21)
F01.25 (0x0119) RUN	Deceleration time 2	V/F SVC FVC PMVF PMSVC PMFVC Set the value of deceleration time 2.	Depending on power level (Changing with F01.21)

◇ **F01.26~F01.27 Acceleration/Deceleration Time 3**

Parameter Code (Address)	Name	Description	Default (Range)
F01.26 (0x011A) RUN	Acceleration time 3	V/F SVC FVC PMVF PMSVC PMFVC Set the value of acceleration time 3.	Depending on power level (Changing with F01.21)
F01.27 (0x011B) RUN	Deceleration time 3	V/F SVC FVC PMVF PMSVC PMFVC Set the value of deceleration time 3.	Depending on power level (Changing with F01.21)

◇ F01.28~F01.29 Acceleration/Deceleration Time 4

Parameter Code (Address)	Name	Description	Default (Range)
F01.28 (0x011C) RUN	Acceleration time 4	V/F SVC FVC PMVF PMSVC PMFVC Set the value of acceleration time 4.	Depending on power level (Changing with F01.21)
F01.29 (0x011D) RUN	Deceleration time 4	V/F SVC FVC PMVF PMSVC PMFVC Set the value of deceleration time 4.	Depending on power level (Changing with F01.21)

S-Curve Selection

The S-Curve characteristic function can be used to enable smooth start and stop of the unit and reduce the impact on the load.

Set the S-Curve characteristic time at the beginning and the end of acceleration/deceleration as necessary.

This function is enabled with F01.30 = 1 [S-Curve selection = Valid]. Where the system needs high flexibility, such as elevators and lifting applications, F01.30 = 2 [S-Curve selection = Flexible S-Curve].

The S-Curve characteristics during operation switching (forward/reverse rotation) are shown in the figure below.

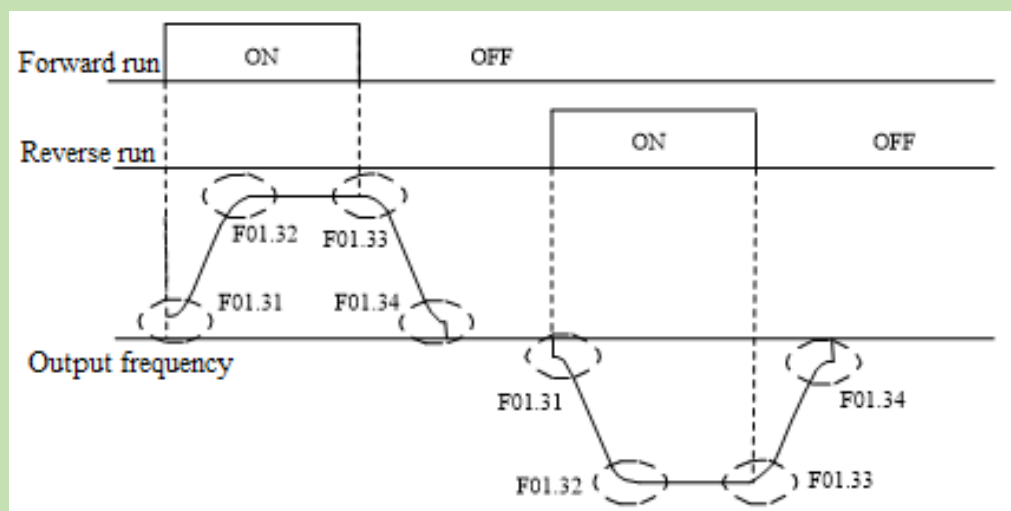

Diagram of S-Curve Characteristics

Note:

- After the S-Curve characteristic is set, the acceleration/deceleration time will be extended in the following way.

Acceleration time = Selected acceleration time + ([F01.31]+[F01.32])/2

Deceleration time = Selected deceleration time + ([F01.33]+[F01.34])/2

◇ **F01.30: S-Curve Selection**

Parameter Code (Address)	Name	Description	Default (Range)
F01.30 (0x011E) STOP	S-Curve Selection	V/F SVC FVC PMVF PMSVC PMFVC Selects whether the S-Curve function is enabled.	1 (0~2)

Note: The S-Curve for jogging is set with F07.33 [Jogging S-Curve selection].

0: Invalid

1: Valid

2: Flexible S-Curve

◇ **F01.31: S-curve Acceleration Start Time**

Parameter Code (Address)	Name	Description	Default (Range)
F01.31 (0x011F) STOP	S-curve acceleration start time	V/F SVC FVC PMVF PMSVC PMFVC Sets the S-curve acceleration start time.	0.20s (0.01s~10.00s)

◇ **F01.32: S-curve Acceleration End Time**

Parameter Code (Address)	Name	Description	Default (Range)
F01.32 (0x0120) STOP	S-curve acceleration end time	V/F SVC FVC PMVF PMSVC PMFVC Sets the S-curve acceleration end time.	0.20s (0.01s~10.00s)

◇ **F01.33: S-Curve Deceleration Start Time**

Parameter Code (Address)	Name	Description	Default (Range)
F01.33 (0x0121) STOP	S-curve deceleration start time	V/F SVC FVC PMVF PMSVC PMFVC Sets the S-curve deceleration start time.	0.20s (0.01s~10.00s)

◇ **F01.34: S-Curve Deceleration End Time**

Parameter Code (Address)	Name	Description	Default (Range)
F01.34 (0x0122) STOP	S-curve deceleration end time	V/F SVC FVC PMVF PMSVC PMFVC Sets the S-curve deceleration end time.	0.20s (0.01s~10.00s)

Switching Frequency of Acceleration/Deceleration Time

◇ **F01.35: Switching Frequency of Acceleration/Deceleration Time**

Parameter Code (Address)	Name	Description	Default (Range)
F01.35 (0x0123) RUN	Switching Frequency of Acceleration/Deceleration Time	V/F SVC FVC PMVF PMSVC PMFVC The frequency for switching of acceleration/deceleration time.	0.00Hz (0.00Hz~F01.10)

The acceleration/deceleration time of the inverter will be automatically switched from acceleration/deceleration time 2 to acceleration/deceleration time 1 when the output frequency reaches the set point of F01.35 [Frequency for Switching of Acceleration/Deceleration Time].

Note:

- The function for switching acceleration/deceleration time is disabled when F01.35 = 0.00 Hz.

Group F01.4x: PWM Control

◇ F01.40: Carrier Frequency

Parameter Code (Address)	Name	Description	Default (Range)
F01.40 (0x0128) RUN	Carrier frequency	V/F SVC FVC PMVF PMSVC PMFVC Set the switching frequency (carrier frequency) of the power transistor in the inverter.	Depending on power level (1.0 kHz - 16.0 kHz)

Change the setting when adjusting the electromagnetic noise or reducing noise and leakage current.

The relationship between carrier Defaults and inverter power levels is shown in the table below.

Inverter Power	Default of Carrier Frequency
<=11kW	4.0kHz
<=45kW	3.0kHz
Others	2.0kHz

Note:

- The carrier is defaulted to 2.0 kHz during DC braking.
- The carrier is defaulted to 2.0 kHz during Auto-tuning.

◇ F01.41: PWM Control Mode

Parameter Code (Address)	Name	Description	Default (Range)
F01.41 (0x0129) RUN	PWM control mode	V/F SVC FVC PMVF PMSVC PMFVC PWM control is optimized with this parameter setting.	1111 (0000~1211)

LED"0": Carrier dependency on temperature

0: Independent of temperature

1: Dependent on temperature

When the temperature of the inverter is too high, the inverter will automatically reduce the carrier frequency. This function can reduce the switching loss of power devices and prevent the inverter from skipping overheat fault.

LED"00": Carrier dependency on output frequency

0: Independent of output frequency

1: Dependent on output Frequency

When the correlation between the carrier and output frequency is effective, the inverter can automatically adjust the carrier frequency according to the output frequency. This function can improve the low frequency performance and the quietness at high frequency of the inverter.

LED"000": Random PWM Enabling

0: Disabled

1: Valid under V/F mode

2: Valid under vector mode

LED"0000": PWM Modulation Mode Selects the PWM mode of the inverter

0: Three-phase modulation only

1: Automatic switching between two-phase and three-phase modulation

◇ F01.43: Random Carrier Depth

Parameter Code (Address)	Name	Description	Default (Range)
F01.43 (0x012B) RUN	Dead-Time Compensation Gain	V/F SVC FVC PMVF PMSVC PMFVC The gain for dead time compensation.	306 (0~512)

Note:

- When set to 0, dead time compensation is Invalid. Increasing this value will increase the dead-time compensation voltage.
- This value is automatically updated upon completion of Auto-tuning.

◇ **F01.46: Random Carrier Depth**

Parameter Code (Address)	Name	Description	Default (Range)
F01.46 (0x012E) RUN	PWM Random Depth	V/F SVC FVC PMVF PMSVC PMFVC The higher the set point, the greater the carrier fluctuation when random PWM is enabled.	0 (0~20)

6.4 Group F02: Motor 1 Parameters

Group F02 parameters are used to set motor 1 parameters, encoder and motor application parameters.

Group F02.0x: Basic Motor Parameters and Auto-tuning Selection

◇ **F02.00: Motor Type**

Parameter Code (Address)	Name	Description	Default (Range)
F02.00 (0x0200) READ	Motor type	V/F SVC FVC PMVF PMSVC PMFVC Set the type of motor. This parameter is read only.	0 (0~1)

0: Asynchronous motor (AM)

1: Permanent magnet synchronous motor (PM)

Note:

➤ This parameter is read only. F02.00 will be automatically updated when F01.00 [Control mode] is set.

◇ **F02.01: Number of Poles of Motor**

Parameter Code (Address)	Name	Description	Default (Range)
F02.01 (0x0201) STOP	Number of motor poles	V/F SVC FVC PMVF PMSVC PMFVC Set the number of poles of the motor.	4 (2~98)

◇ **F02.02: Rated Power of Motor**

Parameter Code (Address)	Name	Description	Default (Range)
F02.02 (0x0202) STOP	Rated motor power	V/F SVC FVC PMVF PMSVC PMFVC Sets the rated power of motor.	Model setting (0.1 kW~1,000.0 kW)

Note: The Default is the power of the inverter for a G-model unit.

◇ **F02.03: Rated Frequency of Motor**

Parameter Code (Address)	Name	Description	Default (Range)
F02.03 (0x0203) STOP	Rated motor frequency	V/F SVC FVC PMVF PMSVC PMFVC Sets the rated frequency of motor.	50.00Hz (0.01Hz~F01.10)

◇ **F02.04: Rated Speed of Motor**

Parameter Code (Address)	Name	Description	Default (Range)
F02.04 (0x0204) STOP	Rated motor RPM	V/F SVC FVC PMVF PMSVC PMFVC Set the rated speed of motor.	Model setting (0 rpm~ 65,000 rpm)

Note:

When F02.00 [Motor type] is set to synchronous motor, F2.04 [Rated motor speed] is calculated with F2.01 [Motor poles] and F2.03 [Rated motor frequency]. Please set the parameters correctly. Formula: F2.04 [Rated motor speed] = $60 * F2.03 [Rated motor frequency] / (F2.01 [Motor poles] / 2)$.

◇ **F02.05: Rated Voltage of Motor**

Parameter Code (Address)	Name	Description	Default (Range)
F02.05 (0x0205) STOP	Rated motor voltage	V/F SVC FVC PMVF PMSVC PMFVC Set the rated voltage of motor.	Model setting (0 V~1,500 V)

◇ **F02.06: Rated Current of Motor**

Parameter Code (Address)	Name	Description	Default (Range)
F02.06 (0x0206) STOP	Rated motor current	V/F SVC FVC PMVF PMSVC PMFVC Set the rated current of motor.	Model setting (0.1 A ~3,000.0 A)

◇ **F02.07: Motor Parameter Auto-tuning Selection**

Parameter Code (Address)	Name	Description	Default (Range)
F02.07 (0x0207) STOP	Selection of motor parameter Auto-tuning	V/F SVC FVC PMVF PMSVC PMFVC Selection of motor parameter Auto-tuning.	0 (0~20)

Note: The set point of [F02.07] will be automatically set to "0" upon completion of parameter Auto-tuning.

0: No action

1: Rotary Auto-tuning

2: Static Auto-tuning

3: Stator Resistance Auto-tuning

4-20: Reserved

Group F02.1x: Advanced Parameters of Asynchronous Motor

◇ F02.10: no-load Current of Asynchronous Motor

Parameter Code (Address)	Name	Description	Default (Range)
F02.10 (0x020A) STOP	No-load current of asynchronous motor	V/F SVC FVC PMVF PMSVC PMFVC Set the no-load current of asynchronous motor.	Model setting (0.1 A~3,000.0 A)

◇ F02.11: Stator Resistance of Asynchronous Motor

Parameter Code (Address)	Name	Description	Default (Range)
F02.11 (0x020B) STOP	Stator resistance of asynchronous motor	V/F SVC FVC PMVF PMSVC PMFVC Sets the stator resistance of asynchronous motor.	Model setting (0.01 mΩ~60,000 mΩ)

Note: The number of decimal digits is set with the LED"0" of F02.19.

◇ F02.12: Rotor Resistance of Asynchronous Motor

Parameter Code (Address)	Name	Description	Default (Range)
F02.12 (0x020C) STOP	Rotor Resistance of Asynchronous Motor	V/F SVC FVC PMVF PMSVC PMFVC Sets the rotor resistance of asynchronous motor.	Model setting (0.01 mΩ~60,000 mΩ)

Note: The number of decimal digits is set with the LED"00" of F02.19.

◇ F02.13: Stator Leakage Inductance of Asynchronous Motor

Parameter Code (Address)	Name	Description	Default (Range)
F02.13 (0x020D) STOP	Stator leakage inductance of asynchronous motor	V/F SVC FVC PMVF PMSVC PMFVC Sets the stator leakage inductance of asynchronous motor.	Model setting (0.001 mH~6,553.5 mH)

Note: The number of decimal digits is set with the LED"000" of F02.19.

◇ F02.14: Stator Inductance of Asynchronous Motor

Parameter Code (Address)	Name	Description	Default (Range)
F02.14 (0x020E) STOP	Stator Inductance of Asynchronous Motor	V/F SVC FVC PMVF PMSVC PMFVC Sets the stator inductance of asynchronous motor.	Model setting (0.01 mH~65,535 mH)

Note: The number of decimal digits is set with the LED"0000" of F02.19.

◇ **F02.15: Stator Resistance Per-Unit Value**

Parameter Code (Address)	Name	Description	Default (Range)
F02.15 (0x020F) READ	Stator Resistance Per-Unit Value	V/F SVC FVC PMVF PMSVC PMFVC Sets the resistance per-unit value of stator. This parameter is read only.	Actual value conversion (0.01%~50.00%)

◇ **F02.16: Rotor Resistance Per-Unit Value**

Parameter Code (Address)	Name	Description	Default (Range)
F02.16 (0x0210) READ	Rotor Resistance Per-Unit Value	V/F SVC FVC PMVF PMSVC PMFVC Sets the resistance per-unit value of rotor. This parameter is read only.	Actual value conversion (0.01%~50.00%)

◇ **F02.17: Stator Leakage Inductance Per-Unit Value**

Parameter Code (Address)	Name	Description	Default (Range)
F02.17 (0x0211) READ	Stator leakage inductance per-unit value	V/F SVC FVC PMVF PMSVC PMFVC Sets the leakage inductance per-unit value of stator. This parameter is read only.	Actual value conversion (0.01%~50.00%)

◇ **F02.18: Stator Inductance Per-Unit Value**

Parameter Code (Address)	Name	Description	Default (Range)
F02.18 (0x0212) READ	Stator inductance per-unit value	V/F SVC FVC PMVF PMSVC PMFVC Sets the inductance per-unit value of stator. This parameter is read only.	Actual value conversion (0.1%~999.0%)

◇ **F02.19: F02.11 - F02.14 Decimal Point Selection**

Parameter Code (Address)	Name	Description	Default (Range)
F02.19 (0x0213) READ	F02.11 - F02.14 Decimal Point Selection	V/F SVC FVC PMVF PMSVC PMFVC Sets the decimal point of parameters F02.11 - F02.14. This parameter is read only.	0000 (0000~2222)

Note: The Default changes with the power level of the motor and does not change even if Defaults are restored.

0: No decimal point

1: 1 decimal digit

2: 2 decimal digits

3: 3 decimal digits

LED"0": Sets the number of decimal digits of parameter F02.11

LED"00": F02.12 parameter decimal point setting

LED"000": Sets the number of decimal digits of parameter F02.13

LED"0000": Sets the number of decimal digits of parameter F02.14

Group F02.2x: Advanced Parameters of Synchronous Motor

◇ F02.20: Stator Resistance of Synchronous Motor

Parameter Code (Address)	Name	Description	Default (Range)
F02.20 (0x0214) STOP	Stator Resistance of Synchronous Motor	V/F SVC FVC PMVF PMSVC PMFVC Set the stator resistance of synchronous motor.	Model setting (0.01 mΩ~ 60,000 mΩ)

Note: The number of decimal digits is set with the ones of F02.29.

◇ F02.21: D-Axis Inductance of Synchronous Motor

Parameter Code (Address)	Name	Description	Default (Range)
F02.21 (0x0215) STOP	D-Axis Inductance of Synchronous Motor	V/F SVC FVC PMVF PMSVC PMFVC Set the d-axis inductance of synchronous motor.	Model setting (0.001 mH~ 6,553.5 mH)

Note: The number of decimal digits is set with the LED"00" of F02.29.

◇ F02.22: Q-Axis Inductance of Synchronous Motor

Parameter Code (Address)	Name	Description	Default (Range)
F02.22 (0x0216) STOP	Q-Axis Inductance of Synchronous Motor	V/F SVC FVC PMVF PMSVC PMFVC Set the q-axis inductance of synchronous motor.	Model setting (0.001 mH~ 6,553.5 mH)

Note: The number of decimal digits is set with the LED"000" of F02.29.

◇ F02.23: Back-EMF of Synchronous Motor

Parameter Code (Address)	Name	Description	Default (Range)
F02.23 (0x0217) STOP	Back-EMF of synchronous motor	V/F SVC FVC PMVF PMSVC PMFVC Set the back-EMF of synchronous motor.	Model setting (0 V~1,500 V)

◇ F02.24: Mounting Angle of Synchronous Motor Encoder

Parameter Code (Address)	Name	Description	Default (Range)
F02.24 (0x0218) RUN	Mounting angle of synchronous motor encoder	V/F SVC FVC PMVF PMSVC PMFVC Set the mounting angle of synchronous motor encoder.	Model setting (0.0°~360.0°)

◇ **F02.25: Stator Resistance Per-Unit Value of Synchronous Motor**

Parameter Code (Address)	Name	Description	Default (Range)
F02.25 (0x0219) READ	Stator Resistance Per-Unit Value of Synchronous Motor	V/F SVC FVC PMVF PMSVC PMFVC Set the stator resistance per-unit value of synchronous motor. This parameter is read only.	Actual value conversion (monitor value)

◇ **F02.26: D-Axis Inductance Per-Unit Value of Synchronous Motor**

Parameter Code (Address)	Name	Description	Default (Range)
F02.26 (0x021A) READ	D-Axis Inductance Per-Unit Value of Synchronous Motor	V/F SVC FVC PMVF PMSVC PMFVC Set the d-axis inductance per-unit value of synchronous motor. This parameter is read only.	Actual value conversion (monitor value)

◇ **F02.27: Q-Axis Inductance Per-Unit Value of Synchronous**

Parameter Code (Address)	Name	Description	Default (Range)
F02.27 (0x021B) READ	Q-Axis Inductance Per-Unit Value of Synchronous Motor	V/F SVC FVC PMVF PMSVC PMFVC Set the q-axis inductance per-unit value of synchronous motor. This parameter is read only.	Actual value conversion (monitor value)

Note: The set point of [F02.07] will be automatically set to "0" upon completion of parameter Auto-tuning.

◇ **F02.28: Pulse Width Coefficient of Synchronous Motor**

Parameter Code (Address)	Name	Description	Default (Range)
F02.28 (0x021C) STOP	Pulse width coefficient of synchronous motor	V/F SVC FVC PMVF PMSVC PMFVC Pulse width coefficient of synchronous motor.	Model setting (0.00-99.99)

◇ **F02.29: F02.20 - F02.23 Decimal Point Selection**

Parameter Code (Address)	Name	Description	Default (Range)
F02.29 (0x021D) READ	Decimal place selection for F02.20 - F02.22	V/F SVC FVC PMVF PMSVC PMFVC Set the decimal places of three parameters F02.20 - F02.22. This parameter is read only.	0000 (0000~2222)

Note: The Default changes with the power level of the motor and does not change even if Defaults are restored.

0: No decimal point

1: 1 decimal digit

2: 2 decimal digits

3: 3 decimal digits

LED"0": F02.20 parameter decimal point setting

LED"00": F02.21 parameter decimal point setting

LED"000": F02.22 parameter decimal point setting

LED"0000": Reserved

Group F02.3x - F02.4x: Encoder Parameters

◇ F02.30: Speed Feedback Encoder Type

Parameter Code (Address)	Name	Description	Default (Range)
F02.30 (0x021E) STOP	Types of speed feedback encoder	V/F SVC FVC PMVF PMSVC PMFVC Set the speed feedback encoder type.	0 (0~1)

0: Ordinary ABZ encoder For use together with an optional PG card purchased from us.

1: Resolver For use together with an optional resolver card purchased from us.

◇ F02.31: Encoder Direction

Parameter Code (Address)	Name	Description	Default (Range)
F02.31 (0x021F) STOP	Encoder direction	V/F SVC FVC PMVF PMSVC PMFVC Set the encoder direction.	0 (0~1)

0: In the same direction

1: In the opposite direction

◇ F02.32: ABZ Encoder Z Pulse Detection Selection

Parameter Code (Address)	Name	Description	Default (Range)
F02.32 (0x0220) STOP	ABZ Encoder Z Pulse Detection Selection	V/F SVC FVC PMVF PMSVC PMFVC Sets the ABZ encoder Z pulse detection selection.	1 (0~2)

0: OFF

1: ON (positive pulse)

2: ON (negative pulse)

◇ F02.33: Number of ABZ Encoder Pulse

Parameter Code (Address)	Name	Description	Default (Range)
F02.33 (0x0221) STOP	Number of ABZ encoder pulse	V/F SVC FVC PMVF PMSVC PMFVC Sets the number of ABZ encoder pulse.	1024 (1~10000)

◇ **F02.34: Number of Resolver Poles**

Parameter Code (Address)	Name	Description	Default (Range)
F02.34 (0x0222) STOP	Number of rotary transformer poles	V/F SVC FVC PMVF PMSVC PMFVC Set the number of resolver poles.	2 (2~128)

◇ **F02.35: Encoder Transmission Ratio Numerator**

Parameter Code (Address)	Name	Description	Default (Range)
F02.35 (0x0223) RUN	Encoder transmission ratio numerator	V/F SVC FVC PMVF PMSVC PMFVC Set the numerator of encoder transmission ratio.	1 (1~32767)

◇ **F02.36: Encoder Transmission Ratio Denominator**

Parameter Code (Address)	Name	Description	Default (Range)
F02.36 (0x0224) RUN	Encoder Transmission Ratio Denominator	V/F SVC FVC PMVF PMSVC PMFVC Set the denominator of encoder transmission ratio.	1 (1~32767)

Note: If the encoder is mounted on the non-motor side, the transmission ratio correctly, or closed-loop vector control is impossible.

◇ **F02.37: Encoder Speed Measurement Filter Time**

Parameter Code (Address)	Name	Description	Default (Range)
F02.37 (0x0225) RUN	Encoder speed measurement filter time	V/F SVC FVC PMVF PMSVC PMFVC Set the filter time for encoder speed measurement.	1.0ms (0.0ms~100.0ms)

Note: The speed measurement filter time may be increased appropriately in places with heavy feedback interference with motor encoder. Increase the time with an increment of 1.0 ms to ensure stable operation of the system.

◇ **F02.38: Encoder disconnection Detection Time**

Parameter Code (Address)	Name	Description	Default (Range)
F02.38 (0x0226) RUN	Encoder disconnection detection time	V/F SVC FVC PMVF PMSVC PMFVC Set the time required for encoder disconnection detection.	0.500s (0.100s~60.000s)

Note: disconnection detection is not conducted when [F02.38] encoder disconnection detection time is set to "0".

◇ **F02.47: Allowable Deviation of Z Pulse**

Parameter Code (Address)	Name	Description	Default (Range)
F02.47 (0x022F) RUN	Allowable Deviation of Z Pulse	V/F SVC FVC PMVF PMSVC PMFVC Set the allowable deviation of Z pulse.	0 (0~65535)

◇ **F02.48: Learning Current Value of Z Pulse**

Parameter Code (Address)	Name	Description	Default (Range)
F02.48 (0x0230) RUN	Learning Current Value of Z Pulse	V/F SVC FVC PMVF PMSVC PMFVC Set the learning current value of Z pulse.	0 (0~65535)

◇ **F02.49: Encoder Debug Register**

Parameter Code (Address)	Name	Description	Default (Range)
F02.49 (0x0231) RUN	Encoder Debug Register	V/F SVC FVC PMVF PMSVC PMFVC LED"0": Monitor PG feedback under SVC mode 0: Invalid 1: Valid	0000 (0000~FFFF)

Group F02.5x: Motor Application Parameters**Stator Resistance Online Auto-tuning**◇ **F02.50: Stator Resistance Online Auto-tuning Mode**

Parameter Code (Address)	Name	Description	Default (Range)
F02.50 (0x0232) STOP	Stator resistance Start learning function selection	V/F SVC FVC PMVF PMSVC PMFVC Set the mode of stator resistance online learning.	0 (0~3)

0: Invalid.**1: Learning without updating.****Greater than 1: Learning and updating. Moreover, this value limits the stator resistance increase as learned during each Start learning.****Note:** The stator resistance Auto-tuning function is effective only after the motor self-setting is completed once.

◇ **F02.51: Stator Resistance Online Auto-tuning Coefficient 1**

Parameter Code (Address)	Name	Description	Default (Range)
F02.51 (0x0233) RUN	Stator resistance Start learning coefficient 1	V/F SVC FVC PMVF PMSVC PMFVC Stator resistance Start learning coefficient 1.	0 (0~1000)

Note: This value records the stator resistance increment as updated actually.

◇ **F02.52: Stator Resistance Online Auto-tuning Coefficient 2**

Parameter Code (Address)	Name	Description	Default (Range)
F02.52 (0x0234) RUN	Stator resistance Start learning coefficient 2	V/F SVC FVC PMVF PMSVC PMFVC Stator resistance Start learning coefficient 2.	0 (-20.00%~20.00%)

Note: This value records the voltage increment reference used in stator resistance Start learning. (for debugging and monitoring)

◇ **F02.53: Stator Resistance Online Auto-tuning Coefficient 3**

Parameter Code (Address)	Name	Description	Default (Range)
F02.53 (0x0235) RUN	Stator resistance Start learning coefficient 3	V/F SVC FVC PMVF PMSVC PMFVC Stator resistance Start learning coefficient 3.	0 (0~65535)

Note: This value records the time required for current stabilization in stator resistance Start learning.

Magnetic Pole Search of Synchronous Motor

In the synchronous motor control mode, the initial position of the motor rotor can be obtained upon starting with the magnetic pole search function.

In the closed-loop vector control mode, this function should be used to obtain the initial starting position of the motor when the motor encoder has not learned initial position.

In the open-loop vector control mode, obtaining the initial position of the motor ensures that the output is high and the motor does not reverse upon starting.

for synchronous closed-loop applications using ABZ encoders, the magnetic pole position of the motor is unknown before Z pulse is detected. In this case, it is recommended to enable the magnetic pole search function to ensure a smooth starting process without reserving.

◇ F02.60: Magnetic Pole Search of Synchronous Motor

Parameter Code (Address)	Name	Description	Default (Range)
F02.60 (0x023C) STOP	Magnetic pole search of synchronous motor	V/F SVC FVC PMVF PMSVC PMFVC Set the magnetic pole search function of synchronous motor.	0010 (0000~3223)

LED"0": Closed-loop vector

- 0: OFF
- 1: ON
- 2: ON, started only for the first time on power-on

LED"00": Open-loop vector

- 0: OFF
- 1: ON
- 2: ON, started only for the first time on power-on

LED"000": VF

- 0: OFF
- 1: ON
- 2: ON, started only for the first time on power-on

◇ F02.61: Magnetic Pole Search Current Set Point

Parameter Code (Address)	Name	Description	Default (Range)
F02.61 (0x023D) STOP	Pole search current set point	V/F SVC FVC PMVF PMSVC PMFVC Set the pole search current set point.	0.0% (0.0%~6553.5%)

6.5 Group F03: Vector Control

Group F03.0x: Speed Loop (ASR)

ASR is a function for adjusting torque commands by making the motor speed and the speed command tend to be consistent.

- Before adjustment of ASR parameters
 - Before adjusting ASR parameters, be sure to conduct Auto-tuning and set all motor parameters properly.
 - Adjust the ASR parameters only with the motor connected to the load.
 - When adjusting ASR, it is possible to monitor C00.01 (the LED"0" of F11.20 is set to 1 to select the actual output frequency) and C00.05 [Mechanical Speed] and use analog output signals.

■ Adjustment steps in SVC, FVC, PMSVC, PMFVC Control Modes

Perform the following steps for adjustment of ASR parameters.

1. Run the motor at zero speed or a low speed, and increase F03.06 [Speed Loop Proportional Gain 2] to the extent

that does not cause vibration.

2. Run the motor at zero speed or a low speed, and decrease F03.07 [Speed Loop Integral Time 2] to the extent that does not cause vibration.
3. Run the motor at the set maximum speed to check if vibration occurs.
4. If vibration occurs, increase the set point of F03.07 and decrease the set point of F03.06 until no more vibration occurs.
5. Set the gain in the low speed domain. Run the motor at zero speed or a low speed, and increase F03.02 [Speed Loop Proportional Gain 1] to the extent that does not cause vibration.
6. The ASR proportional gain and integral time can be switched based on the output frequency. If the speed is instable on the low speed side, roughly set about 80% of the frequency at which the actual vibration occurs. If the speed is instable on the high speed side, roughly set about 120% of the frequency at which the actual vibration occurs.

Switching Frequency 1 > Switching Frequency 2

Switching Frequency 1 < Switching Frequency 2

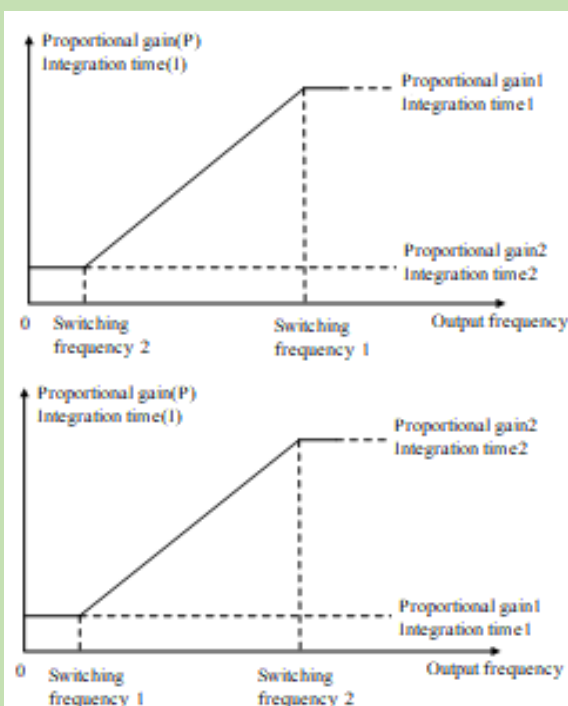

Diagram of Setting of Speed Loop Proportional Gain and Integral Time

◇ **F03.00: ASR Speed Rigidity Class**

Parameter Code (Address)	Name	Description	Default (Range)
F03.00 (0x0300) RUN	ASR speed rigidity class	V/F SVC FVC PMVF PMSVC PMFVC Set the rigidity class of ASR speed.	32 (1~128)

Note:

- Sets the rigidity class. The higher the class, the better the speed rigidity.

◇ **F03.01: ASR Speed Rigidity Mode**

Parameter Code (Address)	Name	Description	Default (Range)
--------------------------	------	-------------	-----------------

F03.01 (0x0301) RUN	ASR speed rigidity mode	V/F SVC FVC PMVF PMSVC PMFVC Set the rigidity mode of ASR speed.	0000 (0000~FFFF)
---------------------------	-------------------------	---	---------------------

◇ **F03.02: ASR (Speed Loop) Proportional Gain 1**

Parameter Code (Address)	Name	Description	Default (Range)
F03.02 (0x0302) RUN	ASR (Speed Loop) Proportional Gain 1	V/F SVC FVC PMVF PMSVC PMFVC Set the ASR (speed loop) proportional gain 1.	10.00 (0.01~100.00)

Increasing the gain improves responsiveness. Usually, the gain should be increased accordingly for larger loads. However, the motor will vibrate if the gain is too high.

◇ **F03.03: ASR (Speed Loop) Integral Time 1**

Parameter Code (Address)	Name	Description	Default (Range)
F03.03 (0x0303) RUN	ASR (Speed Loop) Integral Time 1	V/F SVC FVC PMVF PMSVC PMFVC Set the ASR (speed loop) integral time 1.	0.100s (0.000s~6.000s)

The responsiveness will decrease and the ability to resist external forces will also be impaired if the integral time is too long. Vibration will occur if the integral time is too short.

◇ **F03.04: ASR Filter Time 1**

Parameter Code (Address)	Name	Description	Default (Range)
F03.04 (0x0304) RUN	ASR Filter Time 1	V/F SVC FVC PMVF PMSVC PMFVC Set ASR filter time 1.	0.0ms (0.0ms~100.0ms)

Increase the set point by 0.1 gradually if the unit has low rigidity and is likely to vibrate.

◇ **F03.05: ASR Switching Frequency 1**

Parameter Code (Address)	Name	Description	Default (Range)
F03.05 (0x0305) RUN	ASR switching frequency 1	V/F SVC FVC PMVF PMSVC PMFVC Set ASR switching frequency 1.	0.00Hz (0.00Hz~F01.10)

Note: This parameter determines ASR control parameter selection together with F03.09.

◇ **F03.06: ASR (Speed Loop) Proportional Gain 2**

Parameter Code (Address)	Name	Description	Default (Range)
F03.06 (0x0306) RUN	ASR (Speed Loop) Proportional Gain 2	V/F SVC FVC PMVF PMSVC PMFVC Set the ASR (speed loop) proportional gain 1.	10.00 (0.01~100.00)

Increasing the gain improves responsiveness. Usually, the gain should be increased accordingly for larger loads. However, the motor will vibrate if the gain is too high.

◇ **F03.07: ASR (Speed Loop) Integral Time 2**

Parameter Code (Address)	Name	Description	Default (Range)
F03.07 (0x0307) RUN	ASR (Speed Loop) Integral Time 2	V/F SVC FVC PMVF PMSVC PMFVC Set the ASR (speed loop) integral time 1.	0.100s (0.001s~6.000s)

The responsiveness will decrease and the ability to resist external forces will also be impaired if the integral time is too long. Vibration will occur if the integral time is too short.

◇ **F03.08: ASR Filter Time 2**

Parameter Code (Address)	Name	Description	Default (Range)
F03.08 (0x0308) RUN	ASR Filter Time 2	V/F SVC FVC PMVF PMSVC PMFVC Set ASR filter time 2.	0.0ms (0.0ms~100.0ms)

Increase the set point by 0.1 gradually if the unit has low rigidity and is likely to vibrate.

◇ **F03.09: ASR Switching Frequency 2**

Parameter Code (Address)	Name	Description	Default (Range)
F03.09 (0x0309) RUN	ASR Switching Frequency 2	V/F SVC FVC PMVF PMSVC PMFVC Set ASR switching frequency 2.	0.00Hz (0.00Hz~F01.10)

It is possible to switch the ASR proportional gain and integral time based on the output frequency if the speed is instable on the low speed side or the high speed side.

Description of the speed loop parameter switching with the output frequency when the set point of F03.05 is greater than that of F03.09.

Output Frequency	Velocity Loop Parameter		
	Proportional Gain	Integral Time	Filter Time
Output Frequency \geq F03.05	F03.02	F03.03	F03.04
F03.09 < Output Frequency < F03.05	Linear variation	Linear variation	Linear variation
Output Frequency \leq F03.09	F03.06	F03.07	F03.08

Description of the speed loop parameter switching with the output frequency when the set point of F03.09 is greater than that of F03.05.

Output Frequency	Velocity Loop Parameter		
	Proportional Gain	Integral Time	Filter Time
Output Frequency \leq F03.05	F03.02	F03.03	F03.04
F03.05 < Output Frequency < F03.09	Linear variation	Linear variation	Linear variation
Output Frequency \geq F03.09	F03.06	F03.07	F03.08
F03.09=F03.05	F03.02	F03.03	F03.04

Group F03.1x: Current Loop and Torque Limit

Sets the PI parameters of current loop in vector control of asynchronous motors and synchronous motors. In the case of vector control, if speed or current oscillation and instability occur, decrease the individual gain values appropriately to keep stability. Increasing individual gain values may improve the dynamic response of the motor.

◇ F03.10: Current Loop D-Axis Proportional Gain

Parameter Code (Address)	Name	Description	Default (Range)
F03.10 (0x030A) RUN	Current loop D-axis proportional gain	V/F SVC FVC PMVF PMSVC PMFVC Set the current loop D-axis proportional gain.	1.000 (0.001~4.000)

◇ F03.11: Current Loop D-Axis Integral Gain

Parameter Code (Address)	Name	Description	Default (Range)
F03.11 (0x030B) RUN	Current loop D-axis integral gain	V/F SVC FVC PMVF PMSVC PMFVC Set the current loop D-axis integral gain.	1.000 (0.001~4.000)

◇ F03.12: Current Loop Q-Axis Proportional Gain

Parameter Code (Address)	Name	Description	Default (Range)
F03.12 (0x030C) RUN	Current Loop Q-Axis Proportional Gain	V/F SVC FVC PMVF PMSVC PMFVC Set the current loop Q-axis proportional gain.	1.000 (0.001~4.000)

◇ F03.13: Current Loop Q-Axis Integral Gain

Parameter Code (Address)	Name	Description	Default (Range)
F03.13 (0x030D) RUN	Current Loop Q-Axis Integral Gain	V/F SVC FVC PMVF PMSVC PMFVC Set the current loop Q-axis integral gain.	1.000 (0.001~4.000)

◇ F03.14: Reserved

Parameter Code (Address)	Name	Description	Default (Range)
F03.14 (0x030E) RUN	Reserved	V/F SVC FVC PMVF PMSVC PMFVC Setting.	Depending on model (0-0)

◇ F03.15: Torque Limit in Drive State

Parameter Code (Address)	Name	Description	Default (Range)
F03.15 (0x030F) RUN	Torque Limit in Drive State	V/F SVC FVC PMVF PMSVC PMFVC Sets the torque limit in drive state.	250.0% (0.0%~400.0%)

Note: 100.0% corresponds to the rated torque of motor.

◇ **F03.16: Torque Limit in Power Generation State**

Parameter Code (Address)	Name	Description	Default (Range)
F03.16 (0x0310) RUN	Torque Limit in Power Generation State	V/F SVC FVC PMVF PMSVC PMFVC Set the torque limit in power generation state.	250.0% (0.0%~400.0%)

Note: 100.0% corresponds to the rated torque of motor.

The motor torque output is also limited by the torque converted by F10.01 [Overcurrent suppression point] and F03.34 [Output power limit].

◇ **F03.17: Regenerative Torque Limit at Low Speed**

Parameter Code (Address)	Name	Description	Default (Range)
F03.17 (0x0311) RUN	Regenerative Torque Limit at Low Speed	V/F SVC FVC PMVF PMSVC PMFVC Set the regenerative torque limit at low speed. 100.0% corresponds to the rated torque of motor.	0.0% (0.0%~400.0%)

◇ **F03.18: Frequency and Amplitude for Torque Limit Action at Low Speed**

Parameter Code (Address)	Name	Description	Default (Range)
F03.18 (0x0312) RUN	Frequency and amplitude for torque limit action at low speed	V/F SVC FVC PMVF PMSVC PMFVC Set the frequency and amplitude for torque limit action at low speed.	6.00Hz (0.00Hz~30.00Hz)

◇ **F03.19: Torque Limit Selection**

Parameter Code (Address)	Name	Description	Default (Range)
F03.19 (0x0313) RUN	Torque Limit Selection	V/F SVC FVC PMVF PMSVC PMFVC Set the power generation torque limit and drive torque limit respectively, and the torque monitoring display.	0000 (0000~0177)

LED"0": Select torque limit channel in drive state.

0: Keypad digital

1: Keypad potentiometer (optional outer single-line keypad)

2: AI1

3: AI2

4: Reserved

5: PUL

6: Set via RS485 communication (0x3014)

7: Option card

LED"00": Selects torque limit channel in power generation state.

0: Keypad digital

1: Keypad potentiometer (optional outer single-line keypad)

2: AI1

3: AI2

4: Reserved

5: PUL

6: Set via RS485 communication (0x3015)

7: Option card

LED"000":

0: C00.06 Display the torque limit value in drive state

1: C00.06 Display the torque limit value in the power generation state

LED"0000": Reserved

Group F03.2x: Torque Optimization Control

Pull-in Current of Synchronous Motor

The pull-in current is mainly used to improve the load capacity of the motor at low frequencies. F03.22 [Pull-in current frequency] is taken as the divide between high and low frequencies. When the low frequency load is large, the pull-in current at low frequencies can be appropriately increased. As excessive pull-in current will affect the operation efficiency of the motor, the pull-in current should be set depending on load conditions in actual use.

◇ F03.20: Low Frequency Pull-in Current of Synchronous Motor

Parameter Code (Address)	Name	Description	Default (Range)
F03.20 (0x0314) RUN	Low frequency pull-in current of synchronous motor	V/F SVC FVC PMVF PMSVC PMFVC Set the low frequency pull-in current of synchronous motor.	20.0% (0.0%~50.0%)

Note: The set point of 100.0% corresponds to the rated current of motor.

◇ F03.21: High Frequency Pull-in Current of Synchronous Motor

Parameter Code (Address)	Name	Description	Default (Range)
F03.21 (0x0315) RUN	High frequency pull-in current of synchronous motor	V/F SVC FVC PMVF PMSVC PMFVC Set the high frequency pull-in current of synchronous motor.	10.0% (0.0%~50.0%)

Note: The set point of 100.0% corresponds to the rated current of motor.

◇ F03.22: Pull-In Current Frequency of Synchronous Motor

Parameter Code (Address)	Name	Description	Default (Range)
F03.22 (0x0316) RUN	Pull-in current frequency of synchronous motor	V/F SVC FVC PMVF PMSVC PMFVC Set the pull-in current frequency of synchronous motor.	10.0% (0.0%~100.0%)

Note: The set point of 100.0% corresponds to F01.10 [Maximum frequency].

Slip Compensation

In the vector control mode of asynchronous motors, the slip compensation coefficient is used to adjust the speed stabilization accuracy of the motor in the case of open-loop vector control. Increase the value when the speed of the motor is lower than the set point after loading, and vice versa. The recommended value range is between 60% and 160%.

In the case of closed-loop vector control, this value is used to adjust the linearity of the output torque and output current of the motor. Decrease the value when the motor works with a rated load and the motor current deviates notably from the rated value on the nameplate, or decrease the value if the deviation is small. The recommended value range is between 80% and 120%.

◇ F03.23: Slip Compensation

Parameter Code (Address)	Name	Description	Default (Range)
F03.23 (0x0317) RUN	Slip compensation	V/F SVC FVC PMVF PMSVC PMFVC Sets the slip compensation of motor.	100.0% (0.0%~250.0%)

◇ F03.24: Initial Value of Starting Torque

Parameter Code (Address)	Name	Description	Default (Range)
F03.24 (0x0318) RUN	Initial value of starting torque	V/F SVC FVC PMVF PMSVC PMFVC Sets the initial value of starting torque.	0.0% (0.0%~250.0%)

Group F03.3x: Flux Optimization

Field Weakening

In the case of vector control of asynchronous and synchronous motors, the inverter needs to conduct field weakening control of the motor to ensure that the motor speed follows the set speed if the motor working above the rated speed, or when the bus voltage is low and the motor's running speed is near the rated speed.

F03.32 can be used to set the upper limit of field weakening current. Excessive field weakening current will cause irreversible demagnetization of the motor. In most cases, irreversible demagnetization of the motor will not happen if the field weakening current is within the rated current of the motor.

F03.30 - F03.31 set the adjustment parameters of field weakening control. Adjust these parameters when instability occurs in the case of field weakening.

◇ F03.30: Feed-forward Coefficient of Field Weakening

Parameter Code (Address)	Name	Description	Default (Range)
F03.30 (0x031E) RUN	Field weakening feed- forward coefficient	V/F SVC FVC PMVF PMSVC PMFVC Set the feed-forward coefficient of field weakening.	10.0% (0.0%~500.0%)

◇ **F03.31: Field Weakening Control Gain**

Parameter Code (Address)	Name	Description	Default (Range)
F03.31 (0x031F) RUN	Field weakening control gain	V/F SVC FVC PMVF PMSVC PMFVC Set the gain of field weakening control.	10.0% (0.0%~500.0%)

◇ **F03.32: Field Weakening Current Upper Limit**

Parameter Code (Address)	Name	Description	Default (Range)
F03.32 (0x0320) RUN	Field weakening current upper limit	V/F SVC FVC PMVF PMSVC PMFVC Set the upper limit of field weakening current.	60.0% (0.0%~250.0%)

Note: The set point of 100.0% corresponds to the rated current of motor.

◇ **F03.33: Field Weakening Voltage Coefficient**

Parameter Code (Address)	Name	Description	Default (Range)
F03.33 (0x0321) RUN	Field weakening voltage coefficient	V/F SVC FVC PMVF PMSVC PMFVC Set the field weakening voltage coefficient.	97.0% (0.0%~120.0%)

◇ **F03.34: Output Power Limit**

Parameter Code (Address)	Name	Description	Default (Range)
F03.34 (0x0322) RUN	Output power limit	V/F SVC FVC PMVF PMSVC PMFVC Set the output power limit of motor.	250.0% (0.0%~400.0%)

Note: The set point of 100.0% corresponds to the rated power of the motor.

Over-excitation Brake

This parameter is effective for vector control of asynchronous motors. Faster deceleration control can be realized without reporting overvoltage through over-excitation function. The greater the over-excitation gain, the faster the control response. The braking limit is relative to the rated excitation of the motor. The greater the braking limit, the better the braking effect. However, excessive limit will lead to temperature rise when the motor decelerates, and the value may be increased appropriately only when the motor has favorable conditions of heat dissipation.

◇ **F03.35: Over-excitation Brake Gain**

Parameter Code (Address)	Name	Description	Default (Range)
F03.35 (0x0323) RUN	Over-excitation brake gain	V/F SVC FVC PMVF PMSVC PMFVC Set the over-excitation brake gain.	100.0% (0.0%~250.0%)

◇ **F03.36: Over-excitation Brake Limit**

Parameter Code (Address)	Name	Description	Default (Range)
F03.36 (0x0324) RUN	Over-excitation brake limit	V/F SVC FVC PMVF PMSVC PMFVC Set the over-excitation brake limit.	100.0% (0.0%~250.0%)

Energy-saving operation

This parameter is effective for vector control of asynchronous motors. In the case of energy-saving operation, the output current is automatically reduced by analyzing the torque output to reduce the heating loss of the motor and achieve energy-saving.

◇ **F03.37: Energy-Saving running**

Parameter Code (Address)	Name	Description	Default (Range)
F03.37 (0x0325) RUN	Energy-saving running	V/F SVC FVC PMVF PMSVC PMFVC Set the energy-saving running function.	0 (0~1)

0: OFF

1: ON

◇ **F03.38: Lower Excitation Limit in Energy-Saving running**

Parameter Code (Address)	Name	Description	Default (Range)
F03.38 (0x0326) RUN	Lower excitation limit in energy-saving running	V/F SVC FVC PMVF PMSVC PMFVC Set the lower excitation limit in energy-saving running.	50.0% (0.0%~80.0%)

Note: The set point is 100.0% of the rated excitation of motor.

◇ **F03.39: Filter Coefficient in Energy-Saving running**

Parameter Code (Address)	Name	Description	Default (Range)
F03.39 (0x0327) RUN	Filter coefficient of energy-saving running	V/F SVC FVC PMVF PMSVC PMFVC Sets the filter coefficient of energy-saving running.	0.010s (0.000s~6.000s)

Group F03.4x~F03.5x: Torque Control

Torque command setting

◇ F03.40: Torque Control Selection

Parameter Code (Address)	Name	Description	Default (Range)
F03.40 (0x0328) RUN	Torque control selection	V/F SVC FVC PMVF PMSVC PMFVC Set the torque control selection.	0 (0~1)

0: Speed control selection

1: Torque control selection

Note:

- F5.0x = 60 [Multi-Function input terminal = Switch to torque control] with priority higher than F03.40 [Torque control selection].

◇ F03.41: Torque Command Setting

Parameter Code (Address)	Name	Description	Default (Range)
F03.41 (0x0329) RUN	Torque command setting	V/F SVC FVC PMVF PMSVC PMFVC Set how torque commands are set.	0000 (0000~0599)

LED"0": Torque Setting Channel A

- 0: Torque set with numbers Set with F03.42.
- 1: Set with Keypad potentiometer (optional outer single-line keypad)
- 2: AI1 input
- 3: AI2 input
- 4: Reserved
- 5: PUL input
- 6: Set via RS485 communication Communication address at 0x3005.
- 7. Option card Refer to the instructions of the option card for the communication address of the option card.
- 8: Reserved
- 9: Sets with tension calculation

LED"00": Torque Setting Channel B The same as the torque setting channel A

LED"000": Combination of Channels A and B

- 0: Torque setting channel A
- 1: Torque setting channel B
- 2: Sum of frequency setting channel A and frequency setting channel B
- 3: Difference between frequency setting channel A and frequency setting channel B (A - B)
- 4: Frequency setting channel A or frequency setting channel B, whichever the smaller
- 5: Frequency setting channel A or frequency setting channel B, whichever the larger

LED"0000": Reserved

◇ **F03.42: Torque Given by Keypad Digital**

Parameter Code (Address)	Name	Description	Default (Range)
F03.42 (0x032A) RUN	Torque given by digital	V/F SVC FVC PMVF PMSVC PMFVC Set the torque given.	0.0% (0.0%~100.0%)

Note:

- The set point of 100% corresponds to the rated torque of motor.

◇ **F03.43: Torque Input Lower Limit**

Parameter Code (Address)	Name	Description	Default (Range)
F03.43 (0x032B) RUN	Torque input lower limit	V/F SVC FVC PMVF PMSVC PMFVC Set the lower limit of torque input.	0.00% (0.00%~100.00%)

◇ **F03.44: Corresponding Setting of Lower Torque Limit**

Parameter Code (Address)	Name	Description	Default (Range)
F03.44 (0x032C) RUN	Corresponding setting of lower torque limit	V/F SVC FVC PMVF PMSVC PMFVC Set the corresponding setting of lower torque limit.	0.00% (-250.00%~300.00%)

Note: The set point of 100% corresponds to the rated torque of motor.

◇ **F03.45: Torque Input Upper Limit**

Parameter Code (Address)	Name	Description	Default (Range)
F03.45 (0x032D) RUN	Torque input upper limit	V/F SVC FVC PMVF PMSVC PMFVC Set the upper limit of torque input.	100.00% (0.00%~100.00%)

◇ **F03.46: Corresponding Setting of Upper Torque Limit**

Parameter Code (Address)	Name	Description	Default (Range)
F03.46 (0x032E) RUN	Upper torque limit setting	V/F SVC FVC PMVF PMSVC PMFVC Set the upper torque limit.	100.00% (-250.00%~300.00%)

Note: The set point of 100% corresponds to the rated torque of motor.

◇ **F03.47: Torque Filter Time**

Parameter Code (Address)	Name	Description	Default (Range)
F03.47 (0x032F) RUN	Torque filter time	V/F SVC FVC PMVF PMSVC PMFVC Set the torque filter time.	0.100s (0.000s~6.000s)

Filter the torque command signal to reduce the vibration caused by the signal, which will efficiently remove interference from the signal and improve the response time to the command controller.

In case of vibration during torque control, please set a higher set point. However, delayed response may occur if the set point is too high.

//Not included in the instruction manual

◇ F03.48: Speed Limit Selection

Parameter Code (Address)	Name	Description	Default (Range)
F03.48 (0x0330) RUN	Speed limit selection	V/F SVC FVC PMVF PMSVC PMFVC Set the speed limit.	0 (0~1)

0: Frequency command

1: Speed limit number setting

◇ F03.52: Torque Command Upper Limit

Parameter Code (Address)	Name	Description	Default (Range)
F03.52 (0x0334) RUN	Torque command upper limit	V/F SVC FVC PMVF PMSVC PMFVC Set the torque command upper limit.	150.0% (0.0%~300.0%)

◇ F03.53: Torque Command Lower Limit

Parameter Code (Address)	Name	Description	Default (Range)
F03.53 (0x0335) RUN	Torque command lower limit	V/F SVC FVC PMVF PMSVC PMFVC Set the torque command lower limit.	0.0% (0.0%~300.0%)

Note: Set the upper and lower limits based on the absolute value of the linearly processed torque command value.

Speed Limit

◇ F03.54: Torque Control Forward Speed Limit Selection

Parameter Code (Address)	Name	Description	Default (Range)
F03.54 (0x0336) RUN	Selection of torque control forward speed limit	V/F SVC FVC PMVF PMSVC PMFVC Set the torque control forward speed limit.	0 (0~8)

0: The forward speed limit number is set through F03.56.

1: Set with Keypad potentiometer (optional outer single-line keypad)

2: AI1 input

3: AI2 input

4: Reserved

5: PUL input

6: RS485 communication The communication address is 0x3006.

7. Option card Refer to the instructions of the option card for the communication address of the option

card.

8: Reserved

◇ **F03.55: Torque Control Reverse Speed Limit Selection**

Parameter Code (Address)	Name	Description	Default (Range)
F03.55 (0x0337) RUN	Selection of torque control reverse speed limit	V/F SVC FVC PMVF PMSVC PMFVC Set the torque control reverse speed limit.	0 (0~8)

0: The reverse speed limit number is set through F03.57.

1: Set with Keypad potentiometer (optional outer single-line keypad)

2: AI1 input

3: AI2 input

4: Reserved

5: PUL input

6: RS485 communication The communication address is 0x3007.

7: Option card Refer to the Instruction Manual of Option Card for its communication address.

8: Reserved

◇ **F03.56: Torque Control Forward Speed Limit Selection**

Parameter Code (Address)	Name	Description	Default (Range)
F03.56 (0x0338) RUN	Forward speed limit number/gain setting	V/F SVC FVC PMVF PMSVC PMFVC Set the forward speed limit number/gain.	100.0% (0.0%~100.0%)

Note:

➤ When setting the forward speed limit number, the set point of 100.0% corresponds to the maximum frequency.

◇ **F03.57: Torque Control Reverse Speed Limit Selection**

Parameter Code (Address)	Name	Description	Default (Range)
F03.57 (0x0339) RUN	Reverse speed limit number/gain setting	V/F SVC FVC PMVF PMSVC PMFVC Set the reverse speed limit number/gain.	100.0% (0.0%~100.0%)

Note:

➤ When setting the reverse speed limit number, the set point of 100.0% corresponds to the maximum frequency.

Torque Command Gain Changeover

When the output frequency is lower than F03.58, increase or decrease the set torque by setting F03.59.

◇ F03.58: Switching Frequency of the Set Torque Gain

Parameter Code (Address)	Name	Description	Default (Range)
F03.58 (0x033A) RUN	Torque gain switching frequency setting	V/F SVC FVC PMVF PMSVC PMFVC Set the torque gain switching frequency.	1.00Hz (0.00Hz~50.00Hz)

◇ F03.59: Set Torque Gain

Parameter Code (Address)	Name	Description	Default (Range)
F03.59 (0x033B) RUN	Torque setting gain	V/F SVC FVC PMVF PMSVC PMFVC Set the torque gain.	100.0% (0.0%~500.0%)

Group F03.6x: PM High-Frequency Injection

The high-frequency injection function is available at a low speed (10% of the motor rated frequency by default) to increase the torque output.

◇ F03.60: High-Frequency Injection Mode

Parameter Code (Address)	Name	Description	Default (Range)
F03.60 (0x033C) STOP	High-frequency injection mode	V/F SVC FVC PMVF PMSVC PMFVC Set the high-frequency injection mode.	Model Setting (0~5)

To activate the PM motor open-loop control: select 0 when using an SPM motor, while select 0-5 when using an IPM motor.

0: Disabled

1-5: Enabled. The greater the value, the higher the injection frequency.

Note: When the motor saliency ratio (the ratio of F02.22 to F02.21) is less than 1.5, the effect of high-frequency injection on the motor output torque will be reduced.

◇ F03.61: High-Frequency Injection Voltage

Parameter Code (Address)	Name	Description	Default (Range)
F03.61 (0x033D) RUN	High-frequency injection voltage	V/F SVC FVC PMVF PMSVC PMFVC Set the high-frequency injection voltage.	10.0% (0.0%~100.0%)

Note: The set point of 100% corresponds to the motor rated voltage. Generally, there is no need to change this set point after Auto-tuning.

◇ F03.62: Cutoff Frequency of High-Frequency Injection

Parameter Code (Address)	Name	Description	Default (Range)
F03.62 (0x033E) RUN	High-frequency injection cutoff frequency	V/F SVC FVC PMVF PMSVC PMFVC Set the cutoff frequency of the high-frequency injection.	10.0% (0.0%~20.0%)

High-frequency injection is Valid when the high-frequency injection action range, motor relative rated frequency, and motor speed are less than this value.

Group F03.7x: Position Compensation

The motor Start can be positioned accurately after the position compensation is enabled.

◇ F03.70: Position Compensation Control

Parameter Code (Address)	Name	Description	Default (Range)
F03.70 (0x0346) RUN	Position compensation control	V/F SVC FVC PMVF PMSVC PMFVC Set the position compensation control. 0:OFF 1:ON	50.0 (0.0~100.0)

◇ F03.71: Position Compensation Gain

Parameter Code (Address)	Name	Description	Default (Range)
F03.71 (0x0347) RUN	Position compensation gain	V/F SVC FVC PMVF PMSVC PMFVC Set the position compensation gain.	0.0 (0.0~100.0)

◇ F03.72: Position Compensation Limiting

Parameter Code (Address)	Name	Description	Default (Range)
F03.72 (0x0348) RUN	Position compensation limiting	V/F SVC FVC PMVF PMSVC PMFVC Set the position compensation limiting.	0.0% (0.0%~100.0%)

◇ F03.73: Position Compensation Range

Parameter Code (Address)	Name	Description	Default (Range)
F03.73 (0x0349) RUN	Position compensation range	V/F SVC FVC PMVF PMSVC PMFVC Set the position compensation range.	0.0% (0.0%~100.0%)

Group F03.8x: Extension Control

MTPA Control

The MTPA control is used to optimize the permanent magnet synchronous motor excitation strategy, so as to maximize the motor output/current. In case of a great inductance difference between the permanent motor shafts D and Q, adjust F03.80 to decrease the motor current under the same load; adjust F03.81 to improve the motor running

stability. This control function is only available for the closed-loop vector of a synchronous motor.

◇ F03.80: MTPA Gain of Synchronous Motor

Parameter Code (Address)	Name	Description	Default (Range)
F03.80 (0x0350) RUN	MTPA gain of synchronous motor	V/F SVC FVC PMVF PMSVC PMFVC Set the MTPA gain of synchronous motor.	100.0% (0.0%~400.0%)

◇ F03.81: MTPA Filter Time of Synchronous Motor

Parameter Code (Address)	Name	Description	Default (Range)
F03.81 (0x0351) RUN	MTPA Filter time of synchronous motor	V/F SVC FVC PMVF PMSVC PMFVC Set the MTPA filter time of synchronous motor.	1.0ms (0.0ms~100.0ms)

6.6 Group F04: V/F Control

Group F04.0x: V/F Control

V/F Curve

◇ F04.00: V/F Curve Selection

Parameter Code (Address)	Name	Description	Default (Range)
F04.00 (0x0400) STOP	V/F curve selection	V/F SVC FVC PMVF PMSVC PMFVC Set the V/F curve.	0 (0~11)

0: V/F straight line

1-9: 1.1-1.9 power V/F torque drop curves, respectively

10: Square V/F curve

11: Custom V/F curve

Note:

- F04.00 = 11 [V/F curve selection = custom V/F curve], which is set through F04.10 - F04.19.
- Straight line and torque drop curves are shown as follows. V/F torque drop curves are available when the frequency is above 30% of the motor rated frequency.

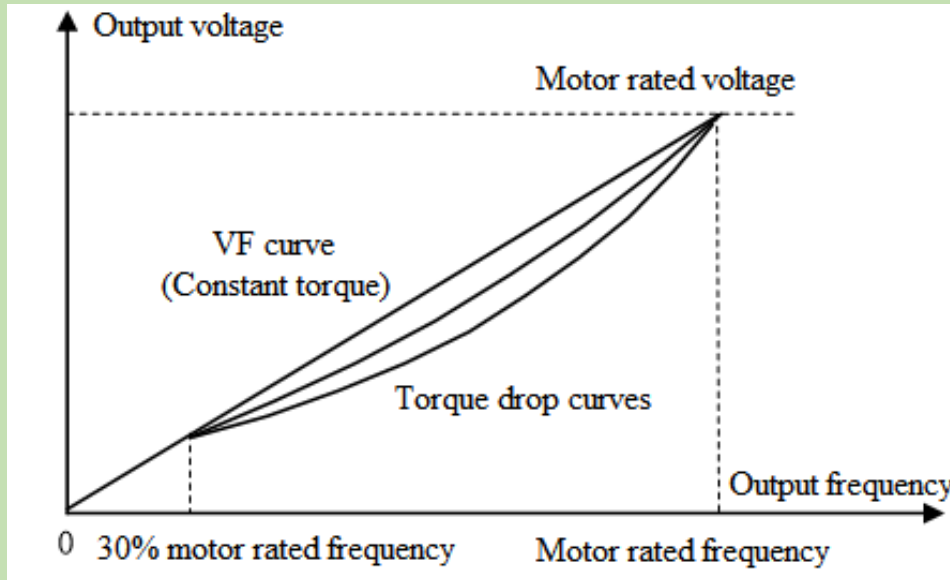

Schematic of V/F Straight Line and Torque Drop Curves

Torque compensation

◇ **F04.01: Torque Boost**

Parameter Code (Address)	Name	Description	Default (Range)
F04.01 (0x0401) RUN	Torque compensation	V/F SVC FVC PMVF PMSVC PMFVC Set the torque boost.	Model setting (0.0%~30.0%)

0.0: Automatic torque boost to compensate the loss on the stator resistance

Other values: Fixed torque boost

Note:

- When F04.01 = 0.0 [Torque boost = automatic torque boost], the motor output is optimized based on the accurate value of stator resistance obtained through F02.07=3 Auto-tuning.
- The fixed torque boost under V/F straight line and torque drop curves are shown as follows.

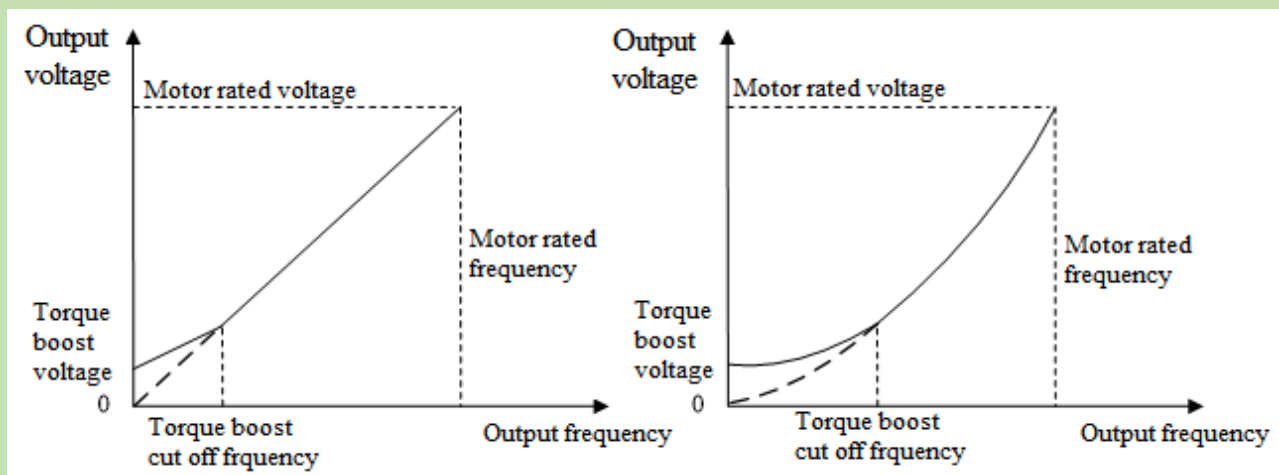

Schematic of Fixed Torque Boost

◇ F04.02: Torque Boost Cutoff Frequency

Parameter Code (Address)	Name	Description	Default (Range)
F04.02 (0x0402) RUN	Torque boost cutoff frequency	V/F SVC FVC PMVF PMSVC PMFVC Set the torque boost cutoff frequency.	100.0% (0.0%~100.0%)

Note: The Default of 100% corresponds to the motor rated frequency.

Slip Compensation

This function enables the output frequency of the inverter to automatically change with the motor load within the set range to dynamically compensate the motor slip frequency, so as to keep the motor at a constant speed, thus reducing the effect of load variation on the motor speed.

◇ F04.03: Slip Compensation Gain

Parameter Code (Address)	Name	Description	Default (Range)
F04.03 (0x0403) RUN	Slip compensation gain	V/F SVC FVC PMVF PMSVC PMFVC Set the slip compensation gain.	0.0% (0.0%~200.0%)

◇ F04.04: Slip Compensation Limiting

Parameter Code (Address)	Name	Description	Default (Range)
F04.04 (0x0404) RUN	Slip compensation limiting	V/F SVC FVC PMVF PMSVC PMFVC Set the slip compensation limiting.	100.0% (0.0%~300.0%)

Note: The set point of 100% corresponds to the rated slip frequency.

◇ F04.05: Slip Compensation Filter Time

Parameter Code (Address)	Name	Description	Default (Range)
F04.05 (0x0405) RUN	Slip compensation filter time	V/F SVC FVC PMVF PMSVC PMFVC Set the slip compensation filter time.	0.200s (0.000s~6.000s)

Oscillation Suppression

Motor current instability or speed oscillation may occur in medium- and high-power application scenarios. This low-frequency resonance is caused by the electrical and mechanical factors, and low-power motor oscillation is slight. Adjust F04.06 and F04.07 to suppress low-frequency resonance, and gradually increase the oscillation suppression gain value while maintaining stability.

◇ F04.06: Oscillation Suppression Gain

Parameter Code (Address)	Name	Description	Default (Range)
--------------------------	------	-------------	-----------------

F04.06 (0x0406) RUN	Oscillation suppression gain	V/F SVC FVC PMVF PMSVC PMFVC Set the oscillation suppression gain.	100.0% (0.0%~900.0%)
---------------------------	------------------------------	--	-------------------------

◇ **F04.07: Oscillation Suppression Filter Time**

Parameter Code (Address)	Name	Description	Default (Range)
F04.07 (0x0407) RUN	Oscillation suppression filter time	V/F SVC FVC PMVF PMSVC PMFVC Set the oscillation suppression filter time.	1.0s (0.0s~100.0s)

V/F Output Voltage Ratio

◇ **F04.08: Output Voltage Percentage**

Parameter Code (Address)	Name	Description	Default (Range)
F04.08 (0x0408) STOP	Output voltage percentage	V/F SVC FVC PMVF PMSVC PMFVC Set the output voltage percentage. 100% corresponds to the motor rated voltage.	100.0% (25.0%~120.0%)

Group F04.1x: Custom V/F Curve

There are 5 adjustable stages of V/F ratio to meet the V/F requirements of different motors.

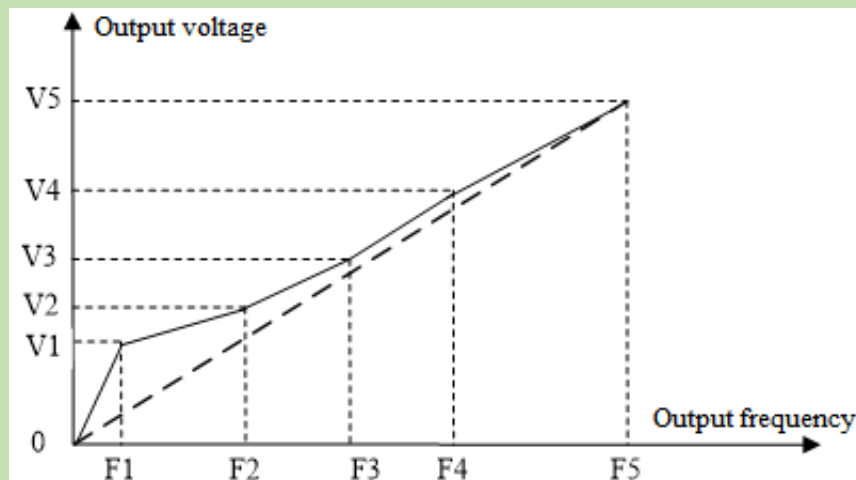

Schematic of Custom Curves

◇ **F04.10: Self-Setting Voltage 1**

Parameter Code (Address)	Name	Description	Default (Range)
F04.10 (0x040A) STOP	Self-setting voltage 1	V/F SVC FVC PMVF PMSVC PMFVC Set the self-setting voltage 1. The set point of 100.0% corresponds to the motor rated voltage.	3.0% (0.0%~100.0%)

◇ **F04.11: Self-Setting Frequency 1**

Parameter Code (Address)	Name	Description	Default (Range)
--------------------------	------	-------------	-----------------

F04.11 (0x040B) STOP	Self-setting frequency 1	V/F SVC FVC PMVF PMSVC PMFVC Set the self-setting frequency 1.	1.00Hz (0.00Hz~F01.10)
----------------------------	-----------------------------	--	---------------------------

◇ **F04.12: Self-Setting Voltage 2**

Parameter Code (Address)	Name	Description	Default (Range)
F04.12 (0x040C) STOP	Self-setting voltage 2	V/F SVC FVC PMVF PMSVC PMFVC Set the self-setting voltage 2. The set point of 100.0% corresponds to the motor rated voltage.	28.0% (0.0%~100.0%)

◇ **F04.13: Self-Setting Frequency 2**

Parameter Code (Address)	Name	Description	Default (Range)
F04.13 (0x040D) STOP	Self-setting frequency 2	V/F SVC FVC PMVF PMSVC PMFVC Set the self-setting frequency 2.	10.00Hz (0.00Hz~F01.10)

◇ **F04.14: Self-Setting Voltage 3**

Parameter Code (Address)	Name	Description	Default (Range)
F04.14 (0x040E) STOP	Self-setting voltage 3	V/F SVC FVC PMVF PMSVC PMFVC Set the self-setting voltage 3. The set point of 100.0% corresponds to the motor rated voltage.	55.0% (0.0%~100.0%)

◇ **F04.15: Self-Setting Frequency 3**

Parameter Code (Address)	Name	Description	Default (Range)
F04.15 (0x040F) STOP	Self-setting frequency 3	V/F SVC FVC PMVF PMSVC PMFVC Set the self-setting frequency 3.	25.00Hz (0.00Hz~F01.10)

◇ **F04.16: Self-Setting Voltage 4**

Parameter Code (Address)	Name	Description	Default (Range)
F04.16 (0x0410) STOP	Self-setting voltage 4	V/F SVC FVC PMVF PMSVC PMFVC Set the self-setting voltage 4. The set point of 100.0% corresponds to the motor rated voltage.	78.0% (0.0%~100.0%)

◇ **F04.17: Self-Setting Frequency 4**

Parameter Code (Address)	Name	Description	Default (Range)
F04.17 (0x0411) STOP	Self-setting frequency 4	V/F SVC FVC PMVF PMSVC PMFVC Set the self-setting frequency 4.	37.50Hz (0.00Hz~F01.10)

◇ **F04.18: Self-Setting Voltage 5**

Parameter Code (Address)	Name	Description	Default (Range)
F04.18 (0x0412) STOP	Self-setting voltage 5	V/F SVC FVC PMVF PMSVC PMFVC Set the self-setting voltage 5. The set point of 100.0% corresponds to the motor rated voltage.	100.0% (0.0%~100.0%)

◇ **F04.19: Self-Setting Frequency 5**

Parameter Code (Address)	Name	Description	Default (Range)
F04.19 (0x0413) STOP	Self-setting frequency 5	V/F SVC FVC PMVF PMSVC PMFVC Set the self-setting frequency 5.	50.00Hz (0.00Hz~F01.10)

Group F04.2x: V/F separation Control

separation control of the output voltage and output frequency.

After the run command is activated, the output voltage and output frequency will change with the set acceleration/deceleration time respectively.

After the stop command is activated, the output voltage and output frequency will change with the set acceleration/deceleration time respectively. The stop mode is selected through F04.24.

Related Parameters:

	Setting Source	Acceleration/ Deceleration Time	Remarks
Frequency	F01.02	F01.22、F01.23	
Voltage	F04.21	F04.22、F04.23	

Note:

- This function is available for T3 models (7.5 kW) and above, as well as T2 models (5.5 kW) and above.
- When the V/F separation control is Valid, the output voltage will be decreased due to over-current suppression.
- After the stop command is Valid, when the output frequency drops below the value specified in F07.11 [Stop Detection Frequency], the inverter will be stop.

◇ **F04.20: V/F separation Voltage Selection**

Parameter Code (Address)	Name	Description	Default (Range)
F04.20 (0x0414) RUN	V/F separation voltage setting	V/F SVC FVC PMVF PMSVC PMFVC LED"0": Channel A LED"00": Channel B 0: Voltage percentage 1: Keypad potentiometer 2: AI1 3: AI2 4: Reserved 5: Terminal pulse PUL 6: PID output 7: RS485 communication 8: Option card 9: Voltage value LED"000": Mode 0: Channel A 1: Channel B 2: A + B 3: A - B 4: MIN (A, B) 5: MAX (A, B)	0000 (0000~0599)

◇ **F04.21: V/F separation Output Voltage Number Setting**

Parameter Code (Address)	Name	Description	Default (Range)
F04.21 (0x0415) RUN	V/F separation output voltage number setting	V/F SVC FVC PMVF PMSVC PMFVC Set the V/F separation voltage value.	0.00% (0.00%~100.00%)

Note: The output is blocked when the output voltage is set as 0%. 100% corresponds to the motor rated voltage.

◇ **F04.22: V/F separation Voltage Acceleration/Deceleration Time**

Parameter Code (Address)	Name	Description	Default (Range)
F04.22 (0x0416) RUN	V/F separation voltage acceleration time	V/F SVC FVC PMVF PMSVC PMFVC Set the V/F separation voltage acceleration time.	10.00s (0.00s~100.00s)
F04.23 (0x0417) RUN	V/F separation voltage deceleration time	V/F SVC FVC PMVF PMSVC PMFVC Set the V/F separation voltage deceleration time.	10.00s (0.00s~100.00s)

◇ **F04.24: V/F separation stop Mode**

Parameter Code (Address)	Name	Description	Default (Range)
F04.24 (0x0418) RUN	V/F separation stop mode	V/F SVC FVC PMVF PMSVC PMFVC Set the V/F separation stop mode. 0: The acceleration/deceleration of output voltage is independent of the acceleration/deceleration of output frequency; 1: The output frequency drops again after the output voltage drops to 0 V.	0 (0~1)

◇ **F04.25: Output Voltage Value Setting**

Parameter Code (Address)	Name	Description	Default (Range)
F04.25 (0x0419) RUN	V/F separation voltage value setting	V/F SVC FVC PMVF PMSVC PMFVC Set the V/F separation voltage value.	0.00V (0.00V~600.00V)

Group F04.3x: V/F Energy-Saving Control

When the motor is light-load, the inverter will automatically adjust the output voltage after achieving a constant speed to improve motor efficiency and save energy.

◇ **F04.30: Automatic Energy-Saving Control**

Parameter Code (Address)	Name	Description	Default (Range)
F04.30 (0x041E) STOP	Automatic energy-saving control	V/F SVC FVC PMVF PMSVC PMFVC Chooses whether to activate the automatic energy-saving control. 0:OFF 1:ON	0 (0~1)

◇ **F04.31: Lower Limit of Energy-Saving Step-Down Frequency**

Parameter Code (Address)	Name	Description	Default (Range)
F04.31 (0x041F) STOP	Lower limit of the energy-saving step-down frequency	V/F SVC FVC PMVF PMSVC PMFVC Set the lower limit of the energy-saving step-down frequency.	15.00Hz (0.00Hz~50.00Hz)

Note: The inverter will automatically exit the energy-saving mode when its output frequency is lower than this value. The value of 100% corresponds to the motor rated frequency.

◇ **F04.32: Lower Limit of Energy-Saving Step-Down Voltage**

Parameter Code (Address)	Name	Description	Default (Range)
F04.32 (0x0420) STOP	Lower limit of the energy-saving step-down voltage	V/F SVC FVC PMVF PMSVC PMFVC Set the lower limit of the energy-saving step-down voltage.	50.0% (20.0%~100.0%)

Note: The set point of 100.0% is the output voltage corresponding to the output frequency when the energy-saving control is invalid.

◇ **F04.33: Regulation Rate of Energy-Saving Step-Down Voltage**

Parameter Code (Address)	Name	Description	Default (Range)
F04.33 (0x0421) RUN	Energy-saving step-down voltage regulation rate	V/F SVC FVC PMVF PMSVC PMFVC Set the energy-saving step-down voltage regulation rate.	0.010V/ms (0.000V/ms~0.200V/ms)

◇ F04.34: Recovery Rate of Energy-Saving Step-Down Voltage

Parameter Code (Address)	Name	Description	Default (Range)
F04.34 (0x0422) RUN	Energy-saving voltage recovery rate	V/F SVC FVC PMVF PMSVC PMFVC Set the energy-saving voltage recovery rate.	0.200V/ms (0.000V/ms~ 2.000V/ms)

6.7 Group F05: Input Terminals

Group F05.0x: Digital Input Terminals (X1 - X10)

Function Selection of Terminals X1 - X10

The inverter is equipped with 5 multi-functional input terminals (X1 - X5) and 5 multi-functional extension terminals (X6 - X10) obtained through an IO extension card. The factory settings are shown in the table below.

Note: IO extension card is optional.

Code	Name	Default	Function
F05.00	Function selection of terminal X1	1	Forward run command (2-wire control)
F05.01	Function selection of terminal X2	2	Reverse run command (2-wire control)
F05.02	Function selection of terminal X3	4	Forward jogging
F05.03	Function selection of terminal X4	5	Reverse jogging
F05.04	Function selection of terminal X5	6	Free stop
F05.05	Function selection of extension terminal X6	0	No operation
F05.06	Function selection of extension terminal X7	0	No operation
F05.07	Function selection of extension terminal X8	0	No operation
F05.08	Function selection of extension terminal X9	0	No operation
F05.09	Function selection of extension terminal X10	0	No operation

Refer to the table below when setting the functions of F05.0x [Function Selection of Multi-Functional Input Terminals].

Set Point	Function	Set Point	Function
0	No function	34	Acceleration/deceleration halt
1	Forward running	35	Swing frequency on
2	Reverse running	36	Swing frequency halt
3	3-wire control (Xi)	37	Swing frequency reset
4	Forward jogging	38	Selection of Keypad keys and self-test display
5	Reverse jogging	39	X5 or X10 (extension terminal) test frequency
6	Free stop	40	Timer trigger terminal
7	Emergency stop	41	Timer reset terminal
8	Fault reset	42	Counter clock input terminal

9	External fault input	43	Counter reset terminal
10	Frequency UP	44	DC brake command
11	Frequency DW	45	Pre-excitation command terminal
12	Frequency UP/DW/reset	46	Reserved
13	Changeover from Channel A to Channel B	47	Reserved
14	Changing the frequency channel combination to A	48	Changeover of the command channel to Keypad
15	Changing the frequency channel combination to B	49	Changeover of the command channel to terminal
16	Multi-Speed Terminal 1	50	Changeover of the command channel to communication
17	Multi-Speed Terminal 2	51	Changeover of the command channel to extension card
18	Multi-Speed Terminal 3	52	Running disabled
19	Multi-Speed Terminal 4	53	Forward disabled
20	PID control cancel	54	Reverse disabled
21	PID control halt	55~59	Reserved
22	PID characteristic changeover	60	Speed/torque control changeover
23	PID parameter changeover	61	Reserved
24	PID setting changeover 1	62	Torque mode frequency upper limit restriction as per the jog frequency
25	PID setting changeover 2	63~87	Reserved
26	PID setting changeover 3	88	Roll diameter reset.
27	PID feedback changeover 1	89	Initial roll diameter selection terminal 1
28	PID feedback changeover 2	90	Initial roll diameter selection terminal 2
29	PID feedback changeover 3	91	Linear speed selection terminal
30	Program running (PLC) halt	92	Tension setting channel changeover.
31	Program running (PLC) reboot	93	Reserved.
32	Acceleration/deceleration time selection terminal 1	94	Winding/unwinding changeover.
33	Acceleration/deceleration rime selection terminal 2	95	Pre-drive terminal.

◇ F05.00: Function Selection of Terminal X1

Parameter Code (Address)	Name	Description	Default (Range)
F05.00 (0x0500) STOP	Function selection of terminal X1	V/F SVC FVC PMVF PMSVC PMFVC Set the function assigned to the multi-functional input terminal X1.	1 (0~95)

◇ **F05.01: Function Selection of Terminal X2**

Parameter Code (Address)	Name	Description	Default (Range)
F05.01 (0x0501) STOP	Function selection of terminal X2	V/F SVC FVC PMVF PMSVC PMFVC Set the function assigned to the multi-functional input terminal X2.	2 (0~95)

◇ **F05.02: Function Selection of Terminal X3**

Parameter Code (Address)	Name	Description	Default (Range)
F05.02 (0x0502) STOP	Function selection of terminal X3	V/F SVC FVC PMVF PMSVC PMFVC Set the function assigned to the multi-functional input terminal X3.	4 (0~95)

◇ **F05.03: Function Selection of Terminal X4**

Parameter Code (Address)	Name	Description	Default (Range)
F05.03 (0x0503) STOP	Function selection of terminal X4	V/F SVC FVC PMVF PMSVC PMFVC Set the function assigned to the multi-functional input terminal X4.	5 (0~95)

◇ **F05.04: Function Selection of Terminal X5**

Parameter Code (Address)	Name	Description	Default (Range)
F05.04 (0x0504) STOP	Function selection of terminal X5	V/F SVC FVC PMVF PMSVC PMFVC Set the function assigned to the multi-functional input terminal X5.	6 (0~95)

◇ **F05.05~F05.09: Function Selection of extension Terminals X6 - X10**

Parameter Code (Address)	Name	Description	Default (Range)
F05.05 (0x0505) STOP	Function selection of terminal X6	V/F SVC FVC PMVF PMSVC PMFVC Set the function assigned to the multi-functional input terminal X6.	0 (0~95)
F05.06 (0x0506) STOP	Function selection of terminal X7	V/F SVC FVC PMVF PMSVC PMFVC Set the function assigned to the multi-functional input terminal X7.	0 (0~95)
F05.07 (0x0507) STOP	Function selection of terminal X8	V/F SVC FVC PMVF PMSVC PMFVC Set the function assigned to the multi-functional input terminal X8.	0 (0~95)
F05.08 (0x0508) STOP	Function selection of terminal X9	V/F SVC FVC PMVF PMSVC PMFVC Set the function assigned to the multi-functional input terminal X9.	0 (0~95)

F05.09 (0x0509) STOP	Function selection of terminal X10	V/F SVC FVC PMVF PMSVC PMFVC Set the function assigned to the multi-functional input terminal X10.	0 (0~95)
----------------------------	--	---	-------------

Set Point of Multi-Function Input

Set the functions assigned to F05.00~F05.09.

0: No function.

It indicates that the terminal is deactivated. When a terminal is idle, it is recommend to set the value as "0" to prevent wrong operation.

1: Forward running

When the run command is set by this terminal, if F05.20 [Terminal Control Mode] is set as "0: 2-wire control 1" and the terminal is activated, the inverter runs reversely. Refer to F05.20 [Terminal Control Mode] for the functions of other control modes and F07.03 [Start Protection Selection] for the Start protection characteristics.

2: Reverse running

When the run command is set by this terminal, if F05.20 [Terminal Control Mode] is set as "0: 2-wire control 1" and the terminal is activated, the inverter runs reversely. Refer to F05.20 [Terminal Control Mode] for the functions of other control modes and F07.03 [Start Protection Selection] for the Start protection characteristics.

3: 3-Wire control (Xi)

When the run command is set by this terminal, if F05.20 [Terminal Control Mode] is set as "2 (3): 3-wire control 1 (2)", the terminal is a 3-wire control terminal (Xi). Refer to F05.20 [Terminal Control Mode] for details; meanwhile, the Start protection characteristics are deactivated. Refer to F07.03 [Start Protection Selection] for details.

4: Forward jogging

5: Reverse jogging

When the forward/reverse jog command input terminal is activated, the inverter jogs. The terminal jog command is given top priority. Refer to F07.3x [Jogging Parameter Group] for detailed jog setting parameters and F07.03 [Start Protection Selection] for jog protection characteristics.

6: Free stop

When this terminal is activated, the inverter will block the output immediately, and the motor runs freely.

When this terminal remains activated, the inverter will remain stop and reject any Start command.

When the keyboard, RS485 communication, option card and terminals run in the 3-wire control mode, the original run command will not resume after the free stop terminal command is deactivated. To start the inverter, enter the run command again.

7: Emergency stop

If an emergency stop command is entered during the running process of the inverter, the inverter will decelerate as per the deceleration time set through F05.27 [Deceleration Time of Emergency stop by Terminal] until stop.

After entering the emergency stop command, the inverter cannot restart until it shuts down completely. If F07.10 [stop Mode] is set as free stop, the inverter will stop as per the free mode.

When the emergency stop terminal remains activated, the inverter will remain stop and reject any Start command.

When the emergency stop terminal runs in the 2-wire control mode, for whether the original run command resumes after the emergency stop terminal command is deactivated, refer to F07.03 [Start Protection Selection].

When the keyboard, communication, option card and terminals run in the 3-wire control mode, the original run command will not resume after the emergency stop terminal command is deactivated. To start the inverter, please enter the run command again.

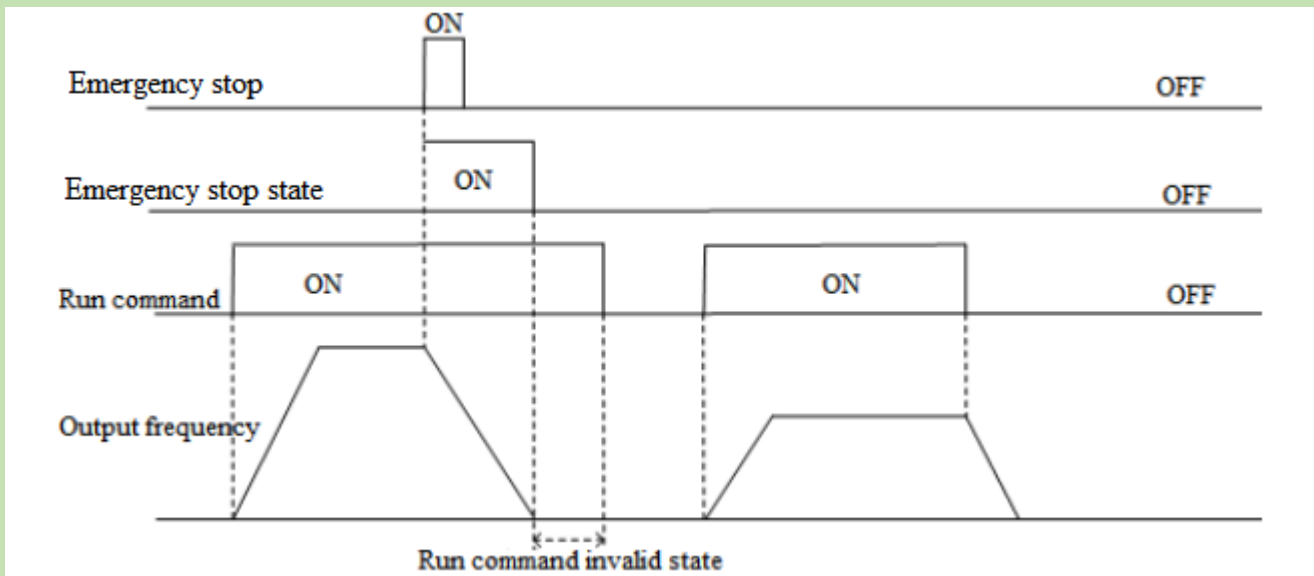

Schematic of Emergency Stop Command

Note: Sudden deceleration may lead to the overvoltage fault of the inverter. In case of an overvoltage fault, the inverter output will be cut off and the motor will run freely and out of control. Therefore, before the emergency stop, set a proper deceleration time through F05.27 [Terminal Emergency stop Deceleration Time], or activate the regenerative braking function.

8: Fault reset

In case of a fault alarm of the inverter, the fault can be reset through the fault reset terminal. When the fault reset terminal runs in the 2-wire control mode, for whether the original run command resumes after the fault is reset, refer to the set point of parameter F07.03 [Start Protection Selection].

9: External fault input

Input the fault signal of external equipment through the external fault input terminal to facilitate the inverter to provide fault monitoring and protection for the external equipment. After receiving the external fault input signal, the inverter will block the output immediately, and the motor will run freely, displaying the fault code E. EF.

10: Frequency UP

11: Frequency DW

Increase or decrease the frequency by controlling the frequency UP/DW terminal. The terminal UP/DW control is available only when parameter F01.02 [Frequency Setting Source Channel A] is set as "7".

Set the memory and reset mode after UP/DW frequency adjustment through F05.25 [Terminal UP/DW Control Selection]. Refer to F05.25 [Terminal UP/DW Control Selection] for details.

Set the acceleration/deceleration rate of the terminal UP/DW control frequency through F05.26 [Acceleration/Deceleration Rate of Terminal UP/DW Control Frequency]. Refer to F05.26 [Acceleration/Deceleration Rate of Terminal UP/DW Control Frequency] for details.

12: Frequency UP/DW reset

Reset the frequency UP/DW through the "frequency UP/DW reset" terminal at any time.

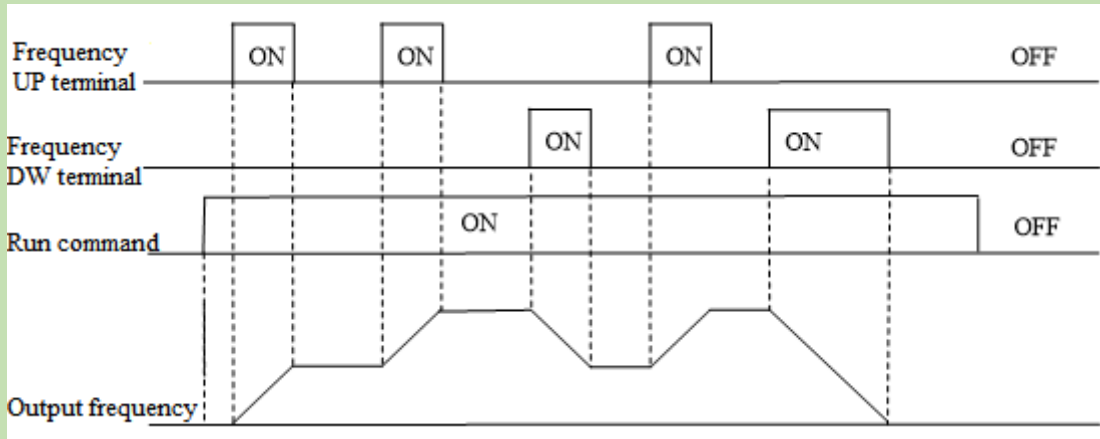

Schematic of Terminal UP/DW Frequency

13: Changeover from Channel A to Channel B**14: Changing the frequency channel combination to A****15: Changing the frequency channel combination to B**

Switch the set frequency channel combination through the terminal.

16: Multi-speed terminal 1**17: Multi-speed terminal 2****18: Multi-speed terminal 3****19: Multi-speed terminal 4**

The input terminal of the multi-speed command can provide 15 stages of speed for selection through code combination. The Multi-speed command is second to the jog command in priority.

20: PID control cancel

When the PID control cancel terminal is activated, it disables the process PID, and force the PID output and internal state to reset; when it is deactivated, PID calculates from the beginning.

21: PID control halt

When the PID control halt terminal is activated, it halts the process PID, and the PID output and internal state remain at the current level; when it is deactivated, PID continues to calculate based on the current value.

22: PID characteristic changeover

When this terminal is activated, the PID feedback characteristic set by the ones place of parameter F13.07 [PID Control Selection] will change; when it is deactivated, the PID output characteristic restores to the PID feedback characteristic set by the ones place of F13.07 [PID Control Selection].

23: PID parameter changeover

This terminal is only activated when F13.17 [PID Parameter Changeover Condition] is set as "1". The PID adjustment proportion, integral and differential parameters are subject to F13.11 - F13.13 [Proportion, Integral, Differential Parameter 1] when the terminal is deactivated and F13.14 - F13.16 [Proportion, Integral, Differential Parameter 1] when the terminal is activated.

24: PID setting changeover 1**25: PID setting changeover 2****26: PID setting changeover 3**

When F13.00 [PID Controller Signal Source] is set as "8: selects by terminal", switch the channel of the PID controller signal source through this set of terminals. Refer to F13.00 [PID Controller Signal Source] for details.

27: PID feedback changeover 1**28: PID feedback changeover 2****29: PID feedback changeover 3**

When F13.03 [PID Controller Feedback Signal Source] is set as "8: selects by terminal", switch the channel of the

PID controller feedback signal source through this set of terminals. Refer to F13.03 [PID Controller Feedback Signal Source] for details.

30: Program run (PLC) halt

When F01.02 [Frequency Setting Source Channel A] is set as "9: PLC setting" and the signal is activated, the program will halt and the inverter will run at the current frequency; when the signal is deactivated, the program and inverter will resume the pre-stop state. Refer to group F14 [Multi-Speed and PLC Functions] for detailed PLC parameters.

31: Program run (PLC) reboot

When F01.02 [Frequency Setting Source Channel A] is set as "9: PLC setting" and the signal is activated, the program will reboot and run from the first stage during stop and program running. Refer to group F14 [Multi-Speed and PLC Functions] for detailed PLC parameters.

32: Acceleration/deceleration time selection terminal 1

33: Acceleration/deceleration time selection terminal 2

The input terminal of the acceleration/deceleration time selection command can provide 4 stages of acceleration/deceleration selection through code combination. When the parameter is not set or the terminal is deactivated, the acceleration/deceleration time is set as "1: activated" by default. Refer to F01.24 - F01.29 [Acceleration/Deceleration Time 2, 3 and 4] for details.

34: Acceleration/deceleration halt

When this terminal is activated during inverter running, the inverter will halt the acceleration/deceleration and maintain the current speed.

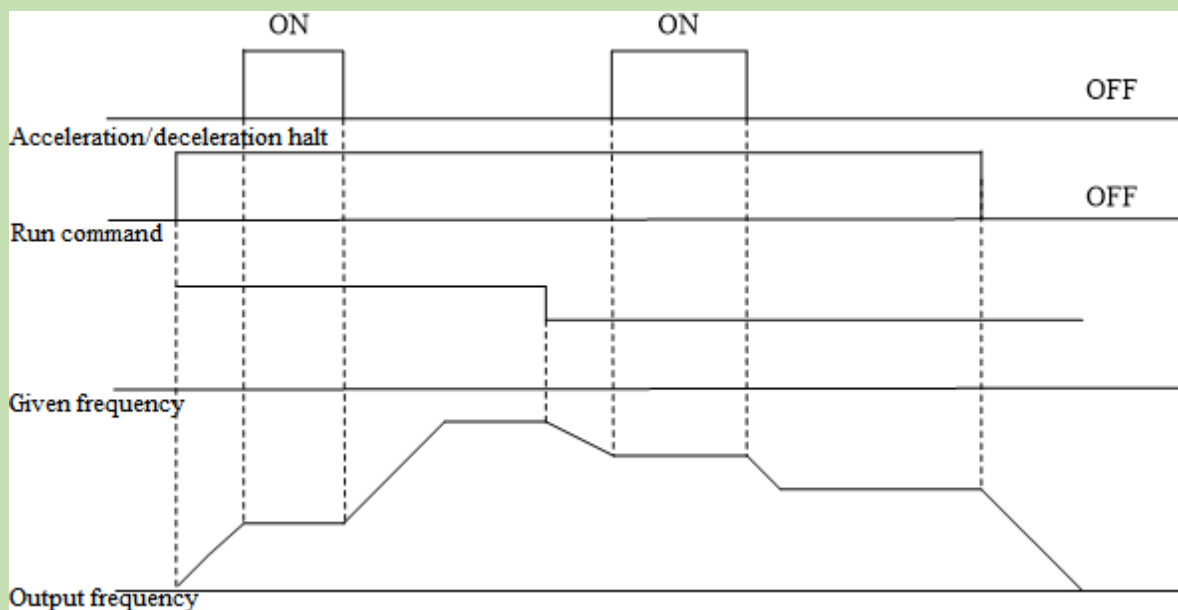

Schematic of Acceleration/Deceleration Halt

35: Swing frequency on

Under swing frequency control, if the input mode is set as manual and this terminal is Valid, the swing frequency control will be Valid and the inverter will run at the swing frequency. Refer to F08.3x [Swing Frequency Control Parameter Group] for details.

36: Swing frequency halt

Under swing frequency control, when this terminal is Valid, the inverter will maintain the current output frequency. The inverter will resume the swing frequency running after the terminal command is Invalid. Refer to F08.3x [Swing Frequency Control Parameter Group] for details.

37: Swing frequency reset

Under swing frequency control, when an effective edge is generated for this terminal, the inverter will run at the original swing frequency first and then restart running at the swing frequency. Refer to F08.3x [Swing Frequency Control Parameter Group] for details.

38: Keypad self-test

When this input terminal is Valid, the Keypad will enter the self-test interface.

39: Test frequency selection

Change the characteristic of terminal X5 on the control board or terminal X10 on the extension card to high-speed pulse port as the PUL input port.

40: Timer trigger terminal

Start the timer port for counting, and the timing is triggered when this terminal is activated. Refer to parameters F08.07 [Timer Time Unit] and F08.08 [Timer Set Point] for details.

41: Timer reset terminal

The timer will reset when this terminal is activated. Refer to parameters F08.07 [Timer Time Unit] and F08.08 [Timer Set Point] for details.

42: Counter clock input terminal

This is a clock input terminal with the counter function. Refer to parameters F08.02 [Counter Maximum Value] and F08.03 [Counter Set Point] for details.

43: Counter reset terminal

The counter will reset when this terminal is activated. Refer to parameters F08.02 [Counter Maximum Value] and F08.03 [Counter Set Point] for details.

44: DC braking command

This command can enable the DC braking when the inverter is stop. Refer to F07.23 [DC Braking Current] for DC braking current set point. Disable the DC braking by entering the run command or jog command. When the inverter is stop, activate this terminal to brake the inverter with the pre-start DC braking; when the inverter is running, activate the terminal to brake the inverter with the stop DC braking.

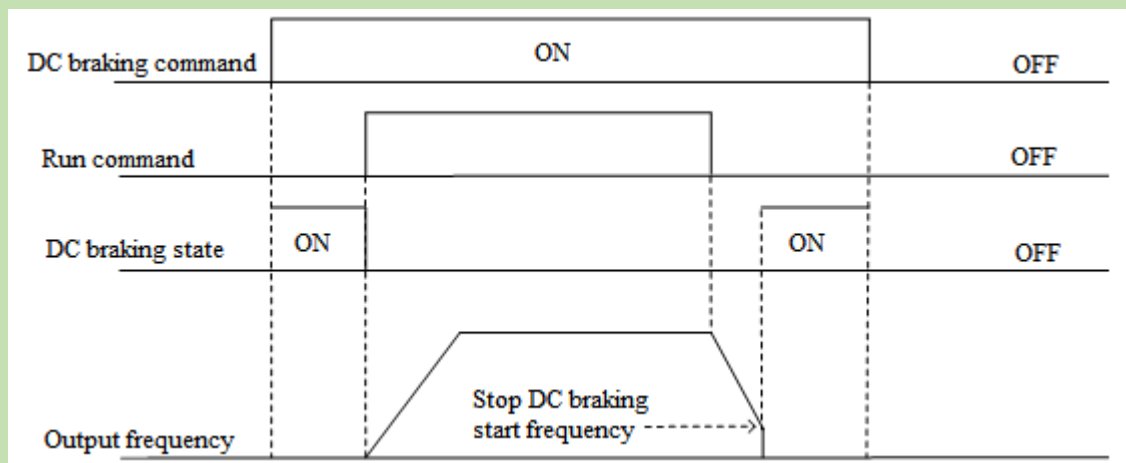

Schematic of DC Braking Command

45: Pre-excitation command terminal

This function can be activated only under the vector control of an asynchronous motor, and can enable the pre-excitation when the inverter is stop. Disable the pre-excitation by entering the run command or jog command.

46-47: Reserved

48: Changeover of the command channel to Keypad

49: Changeover of the command channel to terminal

50: Changeover of the command channel to communication

51: Changeover of the command channel to extension card

There are 4 command channel terminals for the changeover (in the order of priority): Keypad, terminal, communication and extension card.

Note: When two command channel terminals are activated at the same time, keyboard is selected by default.

52: Running disabled

When this terminal is activated, the run command is deactivated during stop, and the inverter will free stop during running.

53: Forward disabled

When this terminal is activated, the forward run command is deactivated during stop, and the inverter will free stop during forward running.

54: Reverse disabled

When this terminal is activated, the reverse run command is deactivated during stop, and the inverter will free stop during reverse running.

55-59: Reserved

60: Speed/torque control changeover

This function is activated only under the vector control. When this terminal is activated, the motor is switched from speed control to torque control.

61: Reserved

62: Torque mode frequency upper limit restriction as per the jog frequency

When this terminal is activated, the torque control forward/reverse speed limit is not determined by F03.54 - F04.57, but by F07.30 [Jog Frequency Setting].

63-87: Reserved

88: Roll diameter reset

When this terminal is activated, the roll diameter under tension control will reset to 0.

89: Initial roll diameter selection terminal 1

Under tension control, when F16.47 [Initial Roll Diameter Source] is set as "0: selection by terminal", the initial roll diameter is jointly determined by this function and "90: initial roll diameter selection terminal 2". Refer to the function codes F16.48 - F16.50 [Initial Roll Diameter] for details.

90: Initial roll diameter selection terminal 2

Under tension control, when F16.47 [Initial Roll Diameter Source] is set as "0: selection by terminal", the initial roll diameter is jointly determined by this function and "89: initial roll diameter selection terminal 1". Refer to the function codes F16.48 - F16.50 [Initial Roll Diameter] for details.

91: Linear speed selection terminal

Under tension control, when F16.56 [Linear Speed Input Source] is set as "0: F16.60/F16.61 terminal selection", the linear speed is F16.60 [Linear Speed Set Point 1] when the terminal is Invalid and F16.61 [Linear Speed Set Point 2] when the terminal is Valid.

92: Tension channel changeover

During stop, switch the set tension channel through this terminal. The tension is applied through the tension channel set by the LED"0" by default when this terminal is Invalid and through the tension channel set by the LED"00" when this terminal is Valid. Refer to the function code F16.03 [Tension Setting Selection] for details.

93: Reserved

94: Winding/unwinding changeover

Under tension control, switch between the winding/unwinding mode through this terminal when F16.02 [Winding Mode Setting] is set as "2: selection by terminal". The inverter runs in the winding/unwinding mode when the terminal is Invalid/Valid.

95: Pre-drive terminal

When this terminal is Valid/Invalid, the pre-drive under tension control is disabled/enabled.

Group F05.1x: Terminals X1~X5 Detection Delay

◇ **F05.10~F05.11: Terminal X1 Detection Delay**

Parameter Code (Address)	Name	Description	Default (Range)
F05.10 (0x050A) RUN	X1 valid detection delay	V/F SVC FVC PMVF PMSVC PMFVC The delay time taken by terminal X1 from invalid to valid.	0.010s (0.000s~6.000s)
F05.11 (0x050B) RUN	X1 invalid detection delay	V/F SVC FVC PMVF PMSVC PMFVC The delay time taken by terminal X1 from valid to invalid.	0.010s (0.000s~6.000s)

Note:

- Increase the terminal X1 detection delay to enhance the filter effect on the input terminal signal.
- The output terminal X1 corresponding to the monitor record takes the value after the delay of F05.10 [X1 Activation Detection Delay] and F05.11 [X1 Deactivation Detection Delay].
- The output terminal X1 corresponding to the fault record takes the value after the delay of F05.10 [X1 Activation Detection Delay] and F05.11 [X1 Deactivation Detection Delay].
- F05.12 [X2 Activation Detection Delay] - F05.19 [X5 Deactivation Detection Delay] are same as F05.10 [X1 Activation Detection Delay] and F05.11 [X1 Deactivation Detection Delay].

◇ **F05.12~F05.13: Terminal X2 Detection Delay**

Parameter Code (Address)	Name	Description	Default (Range)
F05.12 (0x050C) RUN	X2 valid detection delay	V/F SVC FVC PMVF PMSVC PMFVC The delay time taken by terminal X2 from invalid to valid.	0.010s (0.000s~6.000s)
F05.13 (0x050D) RUN	X2 invalid detection delay	V/F SVC FVC PMVF PMSVC PMFVC The delay time taken by terminal X2 from valid to invalid.	0.010s (0.000s~6.000s)

Note:

- Increase the terminal X2 detection delay to enhance the filter effect on input terminal signal.

◇ **F05.14~F05.15: Terminal X3 Detection Delay**

Parameter Code (Address)	Name	Description	Default (Range)
F05.14 (0x050E) RUN	X3 valid detection delay	V/F SVC FVC PMVF PMSVC PMFVC The delay time taken by terminal X3 from invalid to valid.	0.010s (0.000s~6.000s)
F05.15 (0x050F) RUN	X3 invalid detection delay	V/F SVC FVC PMVF PMSVC PMFVC The delay time taken by terminal X3 from valid to invalid.	0.010s (0.000s~6.000s)

Note:

- Increase the terminal X3 detection delay to enhance the filter effect on the input terminal signal.

◇ F05.16~F05.17: Terminal X4 Detection Delay

Parameter Code (Address)	Name	Description	Default (Range)
F05.16 (0x0510) RUN	X4 valid detection delay	V/F SVC FVC PMVF PMSVC PMFVC The delay time taken by terminal X4 from invalid to valid.	0.010s (0.000s~6.000s)
F05.17 (0x0511) RUN	X4 invalid detection delay	V/F SVC FVC PMVF PMSVC PMFVC The delay time taken by terminal X4 from valid to invalid.	0.010s (0.000s~6.000s)

Note:

- Increase the terminal X4 detection delay to enhance the filter effect on the input terminal signal.

◇ F05.18~F05.19: Terminal X5 Detection Delay

Parameter Code (Address)	Name	Description	Default (Range)
F05.18 (0x0512) RUN	X5 valid detection delay	V/F SVC FVC PMVF PMSVC PMFVC The delay time taken by terminal X5 from invalid to valid.	0.010s (0.000s~6.000s)
F05.19 (0x0513) RUN	X5 invalid detection delay	V/F SVC FVC PMVF PMSVC PMFVC The delay time taken by terminal X5 from valid to invalid.	0.010s (0.000s~6.000s)

Note:

- Increase the terminal X5 detection delay to enhance the filter effect on the input terminal signal.

Group F05.2x: Digital Input Terminal Action Selection

◇ F05.20: Terminal's Running Control Mode

Parameter Code (Address)	Name	Description	Default (Range)
F05.20 (0x0514) STOP	Terminal control mode	V/F SVC FVC PMVF PMSVC PMFVC Set the mode of terminal to control running.	0 (0~3)

0: 2-wire control 1

The running and direction are jointly controlled. This is the commonly used 2-wire control mode. By Default, the motor forward/reverse running is determined by terminal X1 (forward run)/X2 (reverse run) command, which is shown as follows:

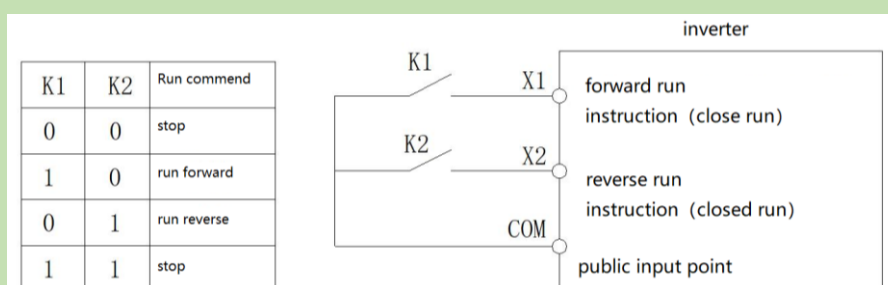

Schematic diagram of two-wire system control 1

1: 2-wire control 2

The running and direction are controlled in a separation way. When using this mode, the running is enabled by the forward run terminal X1. The direction is determined by the reverse run terminal X2, which is shown as follows:

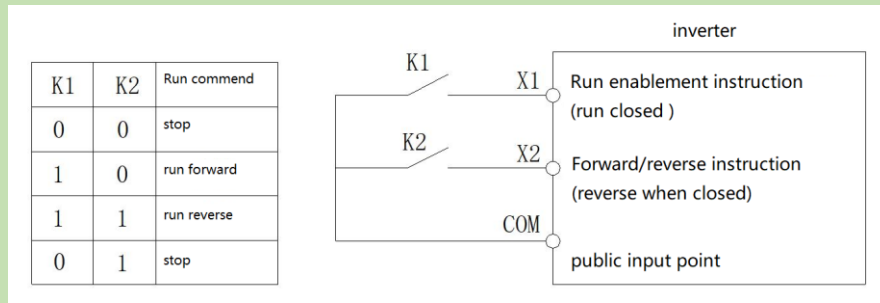

Schematic diagram of two-wire system control 2

2: 3-wire control 1

Under this mode, the 3-wire control terminal (Xi) is a running disable terminal. The run command is produced by the forward run terminal X1, and the direction is controlled by the reverse run terminal X2. The 3-wire control terminal (Xi) is an Valid input terminal.

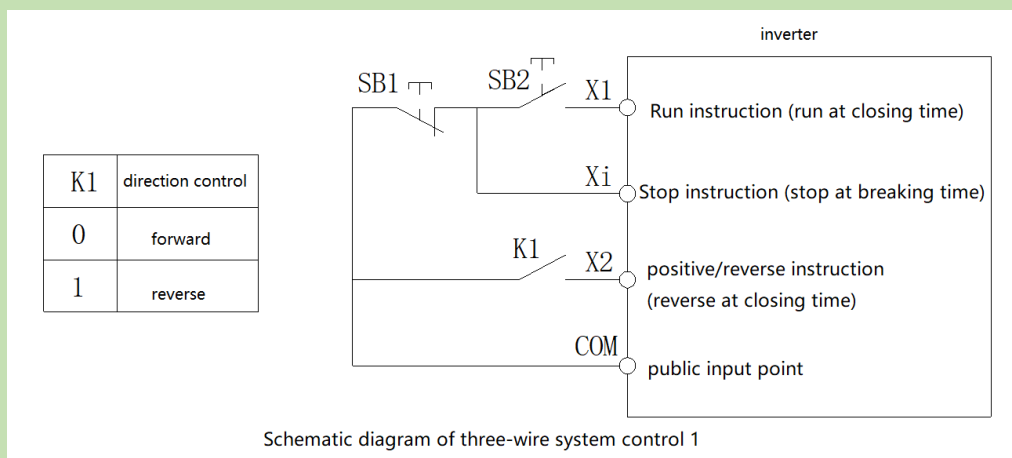

Schematic diagram of three-wire system control 1

3: 3-wire control 2

Under this mode, the 3-wire control terminal (Xi) is a running disable terminal. The run command is produced by the forward run terminal X1 or the reverse run terminal X2, and the direction is controlled by both of them.

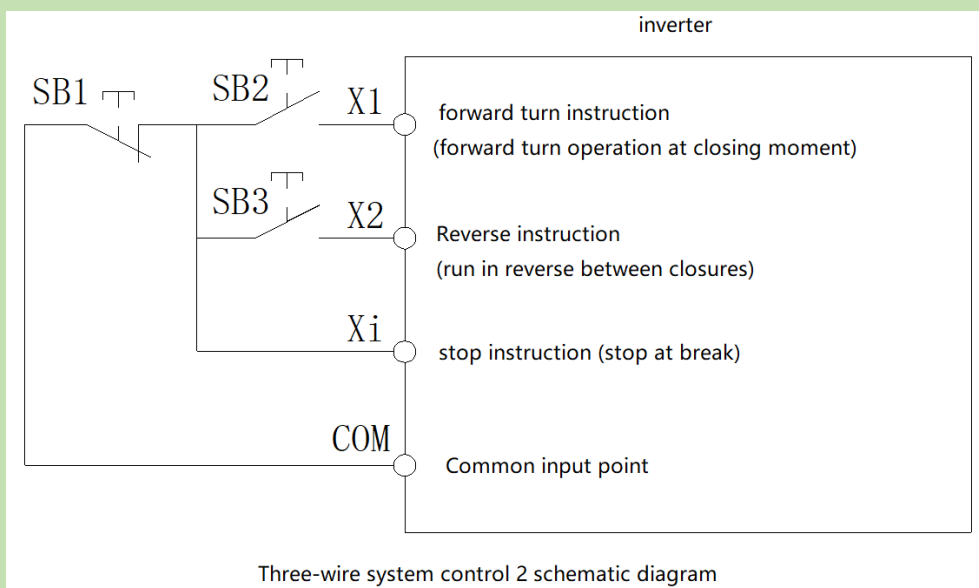

Three-wire system control 2 schematic diagram

Note: SB1: stop button; SB2: forward run button; SB3: reverse run button; "Xi": multi-functional input terminal set as "3" [3-wire control (Xi)].

Note:

- When the setting frequency is lower than the Start frequency, the inverter will stand by, with the running indicator light on.

◇ **F05.22: Characteristic Selection of Terminals X1 - X4**

Parameter Code (Address)	Name	Description	Default (Range)
F05.22 (0x0516) RUN	Terminal X1-X4 characteristic selection	V/F SVC FVC PMVF PMSVC PMFVC Set terminals X1 - X4 as valid when closed or open.	0000 (0000~1111)

Note: By default, the terminals are Valid when closed. If they are set as Valid when open, note that the open terminals will output closed-loop signals for a while when the inverter is powered on.

LED"0": Terminal X1

0: Valid when closed

1: Valid when open

LED"00": Terminal X2

0: Valid when closed

1: Valid when open

LED"000": Terminal X3

0: Valid when closed

1: Valid when open

LED"0000": Terminal X4

0: Valid when closed

1: Valid when open

◇ **F05.23: Characteristic Selection of Terminals X5 - X8**

Parameter Code (Address)	Name	Description	Default (Range)
F05.23 (0x0517) RUN	Terminal X5 - X8 characteristic selection	V/F SVC FVC PMVF PMSVC PMFVC Set terminals X5 - X8 as Valid when closed or open.	0000 (0000~1111)

Note: By default, the terminals are Valid when closed. If they are set as Valid when open, note that the open terminals will output closed-loop signals for a while when the inverter is powered on.

LED"0": Terminal X5

0: Valid when closed

1: Valid when open

LED"00": Terminal X6

0: Valid when closed

1: Valid when open

LED"000": Terminal X7

0: Valid when closed

1: Valid when open

LED"0000": Terminal X8

0: Valid when closed

1: Valid when open

◇ **F05.24: Characteristic Selection of Terminals X9 - X10**

Parameter Code (Address)	Name	Description	Default (Range)
F05.24 (0x0518) RUN	Terminal X9 - X10 characteristic selection	V/F SVC FVC PMVF PMSVC PMFVC Set terminals X9 - X10 as Valid when closed or open.	0000 (0000~1111)

Note: By default, the terminals are valid when closed. If they are set as valid when open, note that the open terminals will output closed-loop signals for a while when the inverter is powered on.

LED"0": Terminal X9

0: Valid when closed

1: Valid when open

LED"00": Terminal X10

0: Valid when closed

1: Valid when open

LED"000": Reserved

LED"0000": Reserved

◇ F05.25: Terminal Frequency Adjustment Mode

Parameter Code (Address)	Name	Description	Default (Range)
F05.25 (0x0519) STOP	Terminal's frequency adjustment mode	V/F SVC FVC PMVF PMSVC PMFVC Set the mode of terminal to adjust frequency UP/DW.	0 (0~2)

Note: This parameter is available when the multi-functional input terminal is set as "10: frequency UP" or "11: frequency DW".

0: Store during power-off/stop

When the terminal switches between frequency UP/DW, the inverter will store the frequency record after power-off or stop. When powered on again, the inverter will increase/decrease frequency according to the frequency before stop.

1: Reset during power-off, and store during stop

When the terminal switches between frequency UP/DW, the inverter will store the frequency record after stop. When turned on again, the inverter will increase/decrease frequency according to the frequency before stop. The inverter does not store the frequency record after power-off, and will run from the frequency of 0.00 Hz.

2: Valid during running, reset during stop

When the terminal switches between frequency UP/DW, the inverter will not store the frequency record after stop or power-off. When turned on again, the inverter will increase/decrease frequency from 0.00 Hz.

◇ F05.26: Acceleration/Deceleration Rate of Terminal UP/DW Control Frequency

Parameter Code (Address)	Name	Description	Default (Range)
F05.26 (0x051A) RUN	Acceleration/deceleration rate of the terminal UP/DW control frequency	V/F SVC FVC PMVF PMSVC PMFVC Set the acceleration/deceleration rate of the terminal UP/DW control frequency.	0.50Hz/s (0.01Hz/s~50.00Hz/s)

Note: The acceleration/deceleration rate will increase when the terminal is always Valid.

◇ F05.27: Deceleration Time of Emergency stop by Terminal

Parameter Code (Address)	Name	Description	Default (Range)
F05.27 (0x051B) RUN	Deceleration time of emergency stop by terminal	V/F SVC FVC PMVF PMSVC PMFVC Set the deceleration time of emergency stop by the terminal command.	1.00s (0.01s~650.00s)

Note: This parameter is available when the multi-functional input terminal is set as "7: emergency stop", the stop mode is set as deceleration, and the emergency stop terminal is Valid.

When the multi-functional input terminal is set as "7: emergency stop", the stop mode is set as free stop, and the emergency stop terminal is Valid, the inverter will free stop.

Group F05.3x: Pulse Frequency Input (PUL) Terminal

◇ F05.30: Pulse Frequency Input Signal Selection

Parameter Code (Address)	Name	Description	Default (Range)
F05.30 (0x051E) STOP	Pulse frequency input signal selection	V/F SVC FVC PMVF PMSVC PMFVC Select the mode according to the terminal input signal.	0 (0~2)

0: Terminal X5 is selected for the frequency input with the maximum frequency of 5.000 kHz.

In this mode, parameters F05.31, F05.33 and C00.19 have three decimal places.

1: Extension terminal X10 is selected for the frequency input with the maximum frequency of 100.00 kHz.

In this mode, parameters F05.31, F05.33 and C00.19 have two decimal places.

2: Terminal X5 is selected for the frequency input with the maximum frequency of 100.00 kHz.

In this mode, parameters F05.31, F05.33 and C00.19 have two decimal places.

Note:

- When F05.30 is set as "2", you need to select a customized control board (this is not supported by a universal machine).
- The pulse frequency signal shall have a 50% duty cycle.

◇ F05.31 - F05.34: Linear Processing of PUL Input

Parameter Code (Address)	Name	Description	Default (Range)
F05.31 (0x051F) RUN	Minimum frequency of PUL input	V/F SVC FVC PMVF PMSVC PMFVC Set the minimum frequency value. Any frequency signal below the value will be processed as this value.	0.000kHz (0.000kHz~50.000kHz, F05.30=0) (0.00kHz~100.00kHz, F05.30=1, 2)
F05.32 (0x0520) RUN	Minimum PUL input frequency setting	V/F SVC FVC PMVF PMSVC PMFVC Set the percentage of the set point for the minimum PUL input frequency.	0.00% (0.00%~100.00%)

F05.33 (0x0521) RUN	Maximum frequency of PUL input	V/F SVC FVC PMVF PMSVC PMFVC Set the maximum frequency value. Any frequency signal above the value will be processed as this value.	5.000kHz (0.00kHz~50.000kHz, F05.30=0) (0.00kHz~100.00kHz, F05.30=1, 2)
F05.34 (0x0522) RUN	Maximum PUL input frequency setting	V/F SVC FVC PMVF PMSVC PMFVC Set the percentage of the set point for the maximum PUL input frequency.	100.00% (0.00%~100.00%)

The linear processing of the PUL input frequency is shown as follows:

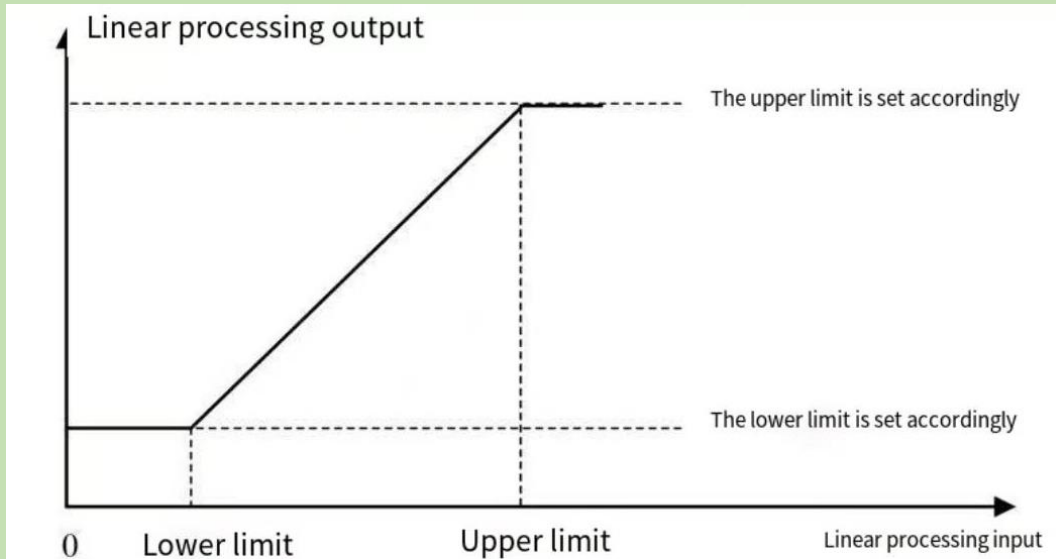

Schematic of Linear Processing of PUL Input Frequency

Note:

- The decimal places of parameters F05.31 and F05.33 are determined by the set point of F05.30.
- The output value of linearly processed PUL is within F05.32 - F05.34. If F01.02 is set as "5: frequency setting Channel A = PUL setting", 100.00% and 0.00% correspond to the maximum frequency and 0.00 Hz, respectively, and the frequency within 0.00% - 100.00% will be linearly processed.

Application selection of PUL input:

Table 11.8 Application Selection of PUL Input

Parameter Code	Name	Set Point
F01.02	Frequency setting Channel A.	5: PUL setting
F01.03	Frequency setting Channel B.	5: PUL setting
F01.08	Run command bound with the set frequency channel.	6: PUL setting
F01.11	Upper frequency limit source selection.	5: PUL setting
F03.41	Torque command setting.	5: PUL setting
F03.54	Torque control forward speed limit selection.	5: PUL setting
F03.55	Torque control reverse speed limit selection.	5: PUL setting
F13.00	Sets the signal source of PID controller.	5: PUL setting
F13.02	Sets the feedback signal source of PID controller.	5: PUL setting

❖ **F05.35: PUL Filter Time**

Parameter Code (Address)	Name	Description	Default (Range)
F05.35 (0x0523) RUN	PUL filter time	V/F SVC FVC PMVF PMSVC PMFVC Set the filter time for input pulse signals.	0.100s (0.000s~9.000s)

Note:

- The longer the filter time, the stronger the anti-interference capability, but the slower the reaction speed.

◇ **F05.36: PUL Cutoff Frequency**

Parameter Code (Address)	Name	Description	Default (Range)
F05.36 (0x0524) RUN	PUL cutoff frequency	V/F SVC FVC PMVF PMSVC PMFVC Set the minimum pulse frequency identified by the PUL port. Any pulse frequency below this value will not be identified by the inverter, but processed as "0 Hz".	0.010kHz (0.000kHz~1.000kHz)

Note:

- The lower the set point, the lower the pulse frequency received by the PUL port. However, when pulse frequency disappears at the PUL port, the inverter will take longer time to identify the pulse as "0 Hz".
- The PUL input signal will go through the cutoff frequency judgment, PUL linear processing and filter processing.

Group F05.4x: Analog input (AI) Characteristic Selection

There are two lines of AI in the inverter, and their input sources are voltage (0 V- 10.0 V) and current (0 mA - 20 mA), respectively. Select the input source according to the signal source through the DIP switch on the control board. The DIP switch is switched to voltage input by Default.

◇ **F05.41: AI1 Input Signal Type**

Parameter Code (Address)	Name	Description	Default (Range)
F05.41 (0x0529) RUN	AI1 signal type	V/F SVC FVC PMVF PMSVC PMFVC Set the AI1 input signal type. 0: Voltage 0 V~10.00 V 1: Current 0 mA~20.00 mA	0 (0~1)

◇ **F05.42: AI2 Input Signal Type**

Parameter Code (Address)	Name	Description	Default (Range)
F05.42 (0x052A) RUN	AI2 signal type	V/F SVC FVC PMVF PMSVC PMFVC Set the AI2 input signal type. 0: Voltage 0 V - 10.00 V 1: Current 0 mA - 20.00 mA	0 (0~1)

◇ **F05.43: AI Curve Selection**

Parameter Code (Address)	Name	Description	Default (Range)
F05.43 (0x052B) RUN	AI curve selection	V/F SVC FVC PMVF PMSVC PMFVC Set the AI curve.	0000 (0000~0022)

LED"0": AI1 curve selection

0: Straight line two-point straight line, by Default.

1: Curve 1 multi-point curve.

2: Curve 2 multi-point curve.

LED"00": AI2 curve selection

0: Straight line two-point straight line, by Default.

1: Curve 1 multi-point curve.

2: Curve 2 multi-point curve.

Group F05.5x: AI Linear Processing

AI1 is processed as follows: the input signal sampled will be filtered within the time set through F05.54 [AI1 Filter Time], and go through linear processing or curve processing, which is selected through F05.43 [AI Curve Selection] (linear processing by default). AI2 is processed in the same way as AI1.

◇ **F05.50 - F05.54: AI1 Linear Processing**

Parameter Code (Address)	Name	Description	Default (Range)
F05.50 (0x0532) RUN	AI1 lower limit	V/F SVC FVC PMVF PMSVC PMFVC Set the lower limit of the AI1 sampling per-unit value. Any per-unit value below this value will be processed as this value.	0.0% (0.0%~100.0%)
F05.51 (0x0533) RUN	AI1 lower limit setting	V/F SVC FVC PMVF PMSVC PMFVC Set the percentage of the set point for the AI1 lower limit.	0.00% (-100.00%~100.00%)
F05.52 (0x0534) RUN	AI1 upper limit	V/F SVC FVC PMVF PMSVC PMFVC Set the upper limit of the AI1 sampling per-unit value. Any per-unit value above this value will be processed as this value.	100.0% (0.0%~100.0%)
F05.53 (0x0535) RUN	AI1 upper limit setting	V/F SVC FVC PMVF PMSVC PMFVC Set the percentage of the set point for the AI1 upper limit.	100.00% (-100.00%~100.00%)
F05.54 (0x0536) RUN	AI1 filter time	V/F SVC FVC PMVF PMSVC PMFVC Set the filter time for AI1 input signals. AI1 input signal will be filtered and then linearly processed.	0.100s (0.000s~6.000s)

Note:

- Switch between voltage input (0.0 V - 10.0 V) and current input (0 mA - 20 mA) of the AI1 input through the DIP switch on the control board.
- C00.16 displays the per-unit value of the AI1 input signal sampled by the inverter, with the range of 0.0% - 100.0%.
- The AI1 input application value is that after curve processing.
- AI1 input signal is the per-unit value after sampled by the inverter.

AI1 Input Signal	Inverter Sampling Per-Unit Value
0V~10V	0.0%~100.0%
0mA~20mA	0.0%~100.0%

The linear processing of AI1 is shown as follows:

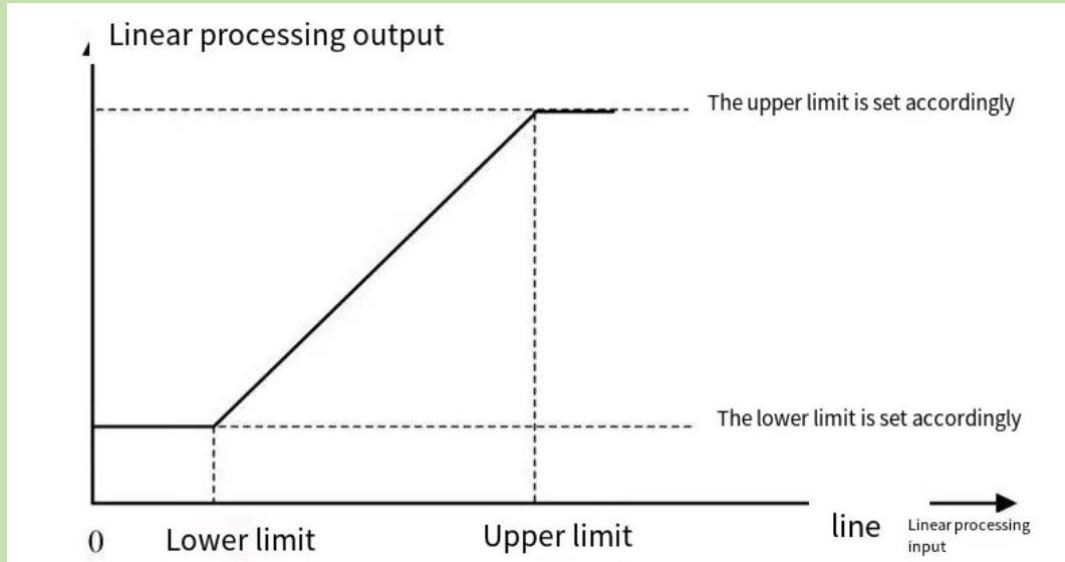

Schematic of AI Linear Processing

Table 11.9 Application Selection of AI1 Input

Parameter Code	Name	Set Point
F01.03	Frequency setting Channel A.	2: AI1 setting
F01.05	Frequency setting Channel B.	2: AI1 setting
F01.08	Run command bound with the set frequency channel.	3: AI1 setting
F01.11	Upper frequency limit source selection.	2: AI1 setting
F03.41	Torque command setting.	2: AI1 setting
F03.54	Torque control forward speed limit selection.	2: AI1 setting
F03.55	Torque control reverse speed limit selection.	2: AI1 setting
F13.00	Set the signal source of PID controller.	2: AI1 setting
F13.02	Set the feedback signal source of PID controller.	2: AI1 setting

◇ F05.55~F05.59: AI2 Linear Processing

Parameter Code (Address)	Name	Description	Default (Range)
F05.55 (0x0537) RUN	AI2 lower limit	V/F SVC FVC PMVF PMSVC PMFVC Set the lower limit of AI2 sampling per-unit value. Any per unit below this value will be processed as this limit.	0.0% (0.0%~100.0%)
F05.56 (0x0538) RUN	AI2 lower limit setting	V/F SVC FVC PMVF PMSVC PMFVC Set the percentage of the set point for the AI2 lower limit.	0.00% (-100.00%~100.00%)
F05.57 (0x0539) RUN	AI2 upper limit	V/F SVC FVC PMVF PMSVC PMFVC Set the upper limit of AI2 sampling per-unit value. Any per unit above this value will be processed as this limit.	100.0% (0.0%~100.0%)

F05.58 (0x053A) RUN	AI2 upper limit setting	V/F SVC FVC PMVF PMSVC PMFVC Set the percentage of the set point for the AI1 upper limit.	100.00% (-100.00%~100.00%)
F05.59 (0x053B) RUN	AI2 filter time	V/F SVC FVC PMVF PMSVC PMFVC Set the filter time for AI2 input signals. AI2 input signal will be filtered and then linearly processed.	0.100s (0.000s~6.000s)

Note:

- Switch between voltage input (0.0V~10.0V) and current input (0mA~20mA) of AI2 input through the DIP switch on the control board.
- C00.17 displays the per-unit value of AI2 input signal sampled by the inverter, with the range of 0.0% ~ 100.0%.
- The AI2 input application value is that after curve processing.
- AI2 input signal is the per-unit value of the signal sampled by the inverter.

AI2 Input Signal	Inverter Sampling Per-Unit Value
0V~10V	0.0%~100.0%
0mA~20mA	0.0%~100.0%

Table 11.10 Application Selection of AI2 Input

Parameter Code	Name	Set Point
F01.03	Frequency setting Channel A.	3: AI2 setting
F01.05	Frequency setting Channel B.	3: AI2 setting
F01.08	Run command bound with the set frequency channel.	4: AI2 setting
F01.11	Upper frequency limit source selection.	3: AI2 setting
F03.41	Torque command setting.	3: AI2 setting
F03.54	Torque control forward speed limit selection.	3: AI2 setting
F03.55	Torque control reverse speed limit selection.	3: AI2 setting
F13.00	Set the signal source of PID controller.	3: AI2 setting
F13.02	Set the feedback signal source of PID controller.	3: AI2 setting

Group F05.6x: AI Curve 1 Processing

The set points of F05.60, F05.62, F05.64 and F05.66 of curve 1 must be set in increasing order.

The set points of F05.70, F05.72, F05.74 and F05.76 of curve 2 must be set in increasing order.

You cannot select curve 1 or curve 2 simultaneously for AI1 and AI2.

Curve 1 and curve 2 can be divided into three straight lines by two inflection points with different slopes to display the corresponding relations more flexibly, as shown in the diagram below:

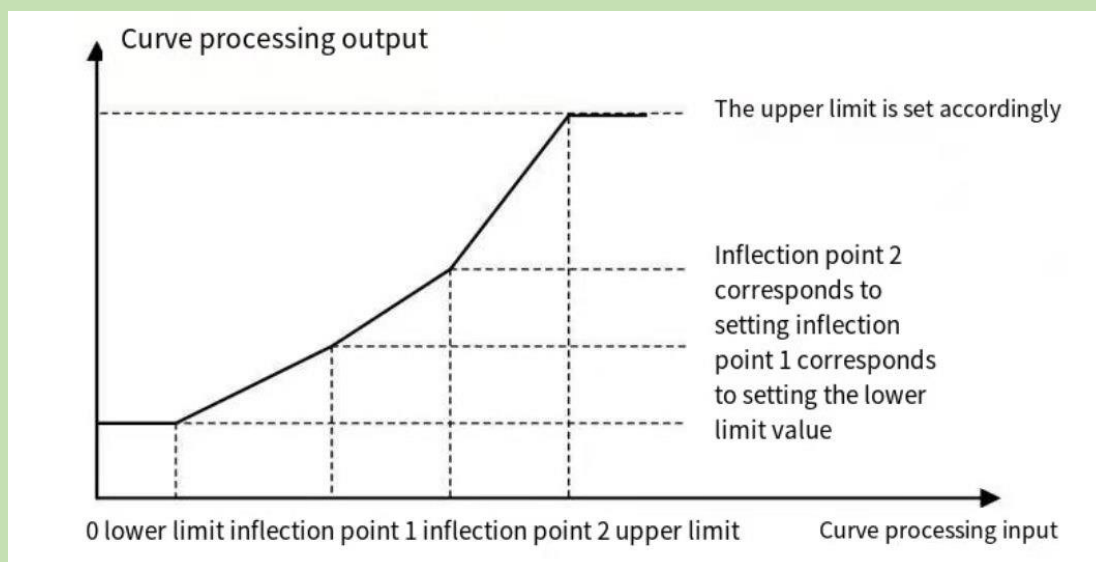

◇ F05.60~F05.67: AI Curve 1 Processing

Parameter Code (Address)	Name	Description	Default (Range)
F05.60 (0x053C) RUN	Curve 1 lower limit	V/F SVC FVC PMVF PMSVC PMFVC Any AI value below this limit will be processed as this value.	0.0% (0.0%~100.0%)
F05.61 (0x053D) RUN	Curve 1 lower limit setting	V/F SVC FVC PMVF PMSVC PMFVC Set the percentage of the set point for the curve 1 lower limit.	0.00% (-100.00%~100.00%)
F05.62 (0x053E) RUN	Inflection point 1 of curve 1	V/F SVC FVC PMVF PMSVC PMFVC Set the value of inflection point 1 of curve 1.	30.0% (0.0%~100.0%)
F05.63 (0x053F) RUN	Setting of inflection point 1 of curve 1	V/F SVC FVC PMVF PMSVC PMFVC Set the percentage of the set point for inflection point 1 of curve 1.	30.00% (-100.00%~100.00%)
F05.64 (0x0540) RUN	Inflection point 2 of curve 1	V/F SVC FVC PMVF PMSVC PMFVC Set the value of inflection point 2 of curve 1.	60.0% (0.0%~100.0%)
F05.65 (0x0541) RUN	Setting of Inflection Point 2 of Curve 1	V/F SVC FVC PMVF PMSVC PMFVC Set the percentage of the set point for inflection point 2 of curve 1.	60.00% (-100.00%~100.00%)
F05.66 (0x0542) RUN	Curve 1 upper limit	V/F SVC FVC PMVF PMSVC PMFVC Any AI value above this limit will be processed as this value.	100.0% (0.0%~100.0%)
F05.67 (0x0543) RUN	Curve 1 upper limit setting	V/F SVC FVC PMVF PMSVC PMFVC Set the percentage of the set point for the curve 1 upper limit.	100.00% (-100.00%~100.00%)

Group F05.7x: AI Curve 2 Processing

◇ F05.70~F05.77: AI Curve 2 Processing

Parameter Code (Address)	Name	Description	Default (Range)
F05.70 (0x0546) RUN	Curve 2 lower limit	V/F SVC FVC PMVF PMSVC PMFVC Any AI value below this limit will be processed as this value.	0.0% (0.0%~100.0%)
F05.71 (0x0547) RUN	Curve 2 lower limit setting	V/F SVC FVC PMVF PMSVC PMFVC Set the percentage of the set point for the curve 2 lower limit.	0.00% (-100.00%~100.00%)
F05.72 (0x0548) RUN	Inflection point 1 of curve 2	V/F SVC FVC PMVF PMSVC PMFVC Set the value of inflection point 1 of curve 2.	30.0% (0.0%~100.0%)
F05.73 (0x0549) RUN	Setting of inflection point 1 of curve 2	V/F SVC FVC PMVF PMSVC PMFVC Set the percentage of the set point for inflection point 1 of curve 2.	30.00% (-100.00%~100.00%)
F05.74 (0x054A) RUN	Inflection point 2 of curve 2	V/F SVC FVC PMVF PMSVC PMFVC Set the value of inflection point 2 of curve 2.	60.0% (0.0%~100.0%)
F05.75 (0x054B) RUN	Setting of inflection point 2 of curve 2	V/F SVC FVC PMVF PMSVC PMFVC Set the percentage of the set point for inflection point 2 of curve 2.	60.00% (-100.00%~100.00%)
F05.76 (0x054C) RUN	Curve 1 upper limit	V/F SVC FVC PMVF PMSVC PMFVC Any AI value above this limit will be processed as this value.	100.0% (0.0%~100.0%)
F05.77 (0x054D) RUN	Curve 2 upper limit setting	V/F SVC FVC PMVF PMSVC PMFVC Set the percentage of the set point for the curve 2 upper limit.	100.00% (-100.00%~100.00%)

Group F05.8x: AI as Digital Input Terminals

Judge high and low levels of AI1 and AI2 according to the input voltage, and use high and low levels to analog digital input terminals. The function selection of AI is the same as that of terminals X1~X10.

◇ F05.80: Characteristic Selection of AI as Digital Input Terminals

Parameter Code (Address)	Name	Description	Default (Range)
F05.80 (0x0550) RUN	Characteristic selection of AI as digital input terminals	V/F SVC FVC PMVF PMSVC PMFVC Set the characteristics of AI as digital input terminals.	00000 (00000~00011)

LED"0": AI1

0: Low level is valid.

1: High level is valid.

LED"00": AI2

0: Low level is valid.

1: High level is valid.

◇ **F05.81: Function Selection of AI1 as a Digital Input Terminal**

Parameter Code (Address)	Name	Description	Default (Range)
F05.81 (0x0551) STOP	Function selection of AI1 as a digital input terminal	V/F SVC FVC PMVF PMSVC PMFVC Set the function of AI1 as a digital input terminal.	0 (0~95)

Note:

- The function selection range of AI1 as a digital input is the same as that of terminals X1 - X10.

◇ **F05.82~F05.83: High/Low Level Setting for AI1**

Parameter Code (Address)	Name	Description	Default (Range)
F05.82 (0x0552) RUN	High level setting for AI1	V/F SVC FVC PMVF PMSVC PMFVC When the sampling per-unit value of AI1 input is higher than this set point, it is the high level.	70.00% (0.00%~100.00%)
F05.83 (0x0553) RUN	Low level setting for AI1	V/F SVC FVC PMVF PMSVC PMFVC When the sampling per-unit value of AI1 input is lower than this set point, it is the low level.	30.00% (0.00%~100.00%)

Note:

- The set point of F05.82 shall be higher than that of F05.83 to distinguish between high and low levels.
- When the AI12 input value is within F05.82~F05.83, a hysteresis judgment will be made according to the previous state to distinguish between high and low levels.

◇ **F05.84: Function Selection of AI2 as a Digital Input terminal**

Parameter Code (Address)	Name	Description	Default (Range)
F05.84 (0x0554) STOP	Function selection of AI2 as a digital input terminal	V/F SVC FVC PMVF PMSVC PMFVC Set the function of AI2 as a digital input terminal.	0 (0~95)

Note:

- The function selection range of AI2 as a digital input is the same as terminals X1~X10.

◇ **F05.85~F05.86: High/Low Level Setting for AI2**

Parameter Code (Address)	Name	Description	Default (Range)
F05.85 (0x0555) RUN	High level setting for AI2	V/F SVC FVC PMVF PMSVC PMFVC When the sampling per unit of AI2 input is higher than this set point, it is the high level.	70.00% (0.00%~100.00%)
F05.86 (0x0556) RUN	Low level setting for AI2	V/F SVC FVC PMVF PMSVC PMFVC When the sampling per unit of AI2 input is lower than this set point, it is the low level.	30.00% (0.00%~100.00%)

Note:

- The set point of F05.85 shall be higher than that of F05.86 to distinguish between high and low levels.
- When the AI2 input value is within F05.85- F05.86, make a hysteresis judgment according to the previous state

to distinguish between high and low levels.

6.8 Group F06: Output Terminals

Parameter group F06 is used to set the analog monitoring of the inverter, so as to select monitoring items, adjust gain and bias, and select high/low level for output signals.

Group F06.0x: Analog Output (AO) Frequency

Parameter group F06.0x is used to set the analog monitoring of inverter, so as to select monitoring items, adjust gain and bias, and select high/low level for output signals.

There is 1 line of AO in the inverter. Select among three forms of signal output (voltage, current and frequency) through the DIP switch. Expand 1 line of AO through the optional extension card.

The calibration of instrument connected to multi-functional AO terminals.

Calibrate the instrument connected to the terminal through F06.02, F06.03, F06.04, F06.05 and F06.06.

Parameter	Name	Set Range	Default
F06.00	AO mode selection	0: 0V~10V 1: 4.00mA~20.00mA 2: 0.00mA~20.00mA 3: FM frequency pulse output	0
F06.01	AO quantity selection	0~19	0
F06.02	AO gain	0.0%~300.0%	100.0%
F06.03	AO bias	-10.0%~10.0%	0.0%
F06.04	AO filter	0.000s~6.000s	0.010s
F06.05	AO as lower limit of FM frequency output	0.00kHz~100.00kHz	0.20kHz
F06.06	AO as upper limit of FM frequency output	0.00kHz~100.00kHz	50.00kHz

The effects of gain and bias are shown as follows.

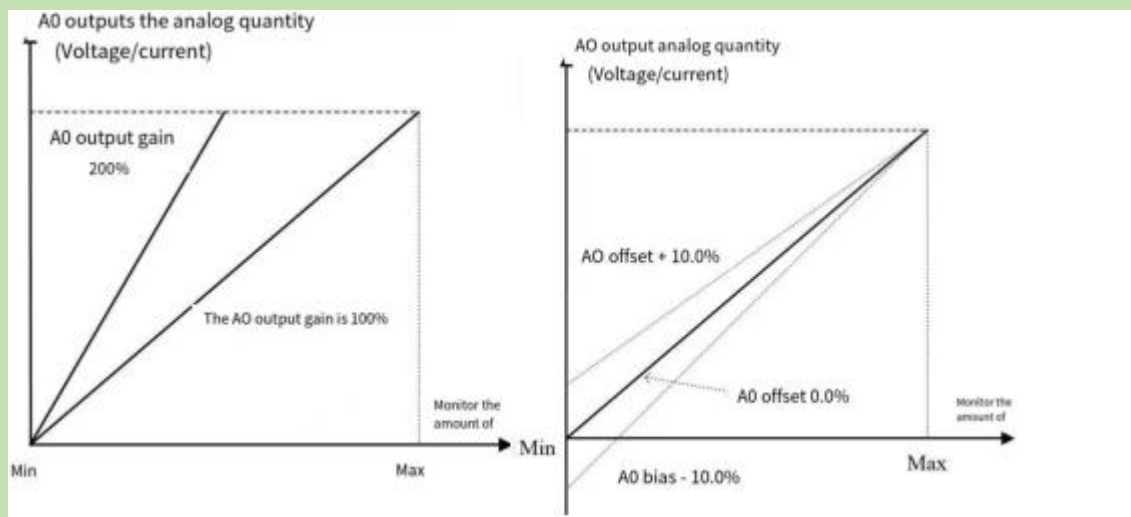

Schematic of AO, Gain and Bias

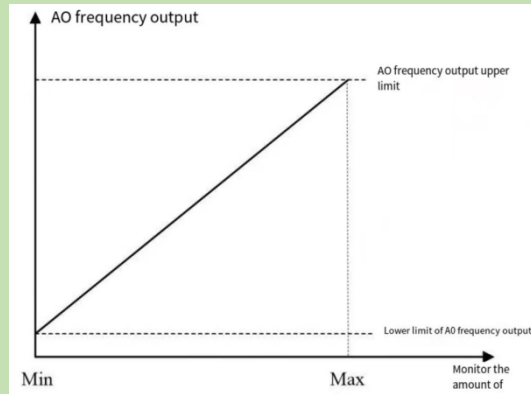

Schematic of AO Pulse Frequency

◇ F06.00: AO Mode Selection

Parameter Code (Address)	Name	Description	Default (Range)
F06.00 (0x0600) RUN	AO mode selection	V/F SVC FVC PMVF PMSVC PMFVC Set the form of AO signals. 0: 0 V~10 V 1: 4.00 mA~20.00 mA 2: 0.00 mA~20.00 mA 3: FM frequency pulse output	0 (0~3)

Note:

- To select different modes for F06.00, flip the DIP switch on the control board to the corresponding position.

AO Mode	Position of the DIP Switch on the Control Board
0: 0 V~10 V	Flip AO-U to ON position.
1: 4.00 mA~20.00 mA	Flip AO-I to ON position.
2: 0.00 mA~20.00 mA	Flip AO-I to ON position.
3: FM frequency pulse output	Flip AO-F to ON position.

◇ F06.01: AO Quantity Selection

Parameter Code (Address)	Name	Description	Default (Range)
F06.01 (0x0601) RUN	AO quantity selection	V/F SVC FVC PMVF PMSVC PMFVC Set the AO quantity.	0 (0~19)

Set point and monitoring volume

Set Point	Name	Value Corresponding to 0.00%	Value Corresponding to 100.00%
0	Set frequency	0.00Hz	Maximum frequency.
1	Output Frequency	0.00Hz	Maximum frequency.
2	Output Current	0.00A	Twice the motor rated current.
3	Input Voltage	0.0V	Twice the rated voltage of the inverter.
4	Output voltage	0.0V	Motor rated voltage.
5	Mechanical Speed	0rpm	Speed corresponding to the maximum frequency.

6	Set Torque	0.00% of torque	200% of torque.
7	Output Torque	0.00% of torque	200% of torque.
8	PID Set Value	0.00% of PID setting	100% of PID setting.
9	PID Feedback Value	0.00% of PID feedback	100% of PID feedback.
10	Output Power	0 kW	Twice the motor rated output power.
11	Bus Voltage	0 V	Twice the inverter rated DC voltage.
12	AI1 input value	AI1 input lower limit	AI1 input upper limit.
13	AI2 input value	AI2 input lower limit	AI2 input upper limit.
14	Reserved		
15	PUL input value	PUL input lower limit	PUL input upper limit.
16	Module Temperature 1	0°C	100°C.
17	Module Temperature 2	0°C	100°C.
18	RS485 communication setting	0	1000.
19	Virtual terminal vY1	Output invalid	Output valid.

Note:

- The rated DC voltage is the inverter rated voltage multiplies 1.414.

◇ **F06.02: AO Gain**

Parameter Code (Address)	Name	Description	Default (Range)
F06.02 (0x0602) RUN	AO gain	V/F SVC FVC PMVF PMSVC PMFVC Set the AO gain.	100.0% (0.0%~300.0%)

◇ **F06.03: AO Bias**

Parameter Code (Address)	Name	Description	Default (Range)
F06.03 (0x0603) RUN	AO bias	V/F SVC FVC PMVF PMSVC PMFVC Set the bias of AO signals.	0.0% (-10.0%~10.0%)

◇ **F06.04: AO Filter**

Parameter Code (Address)	Name	Description	Default (Range)
F06.04 (0x0604) RUN	AO filter	V/F SVC FVC PMVF PMSVC PMFVC Sets the filter time of analog output signal.	0.010s (0.000s~6.000s)

◇ F06.05: Setting AO as the FM Output Lower Limit

Parameter Code (Address)	Name	Description	Default (Range)
F06.05 (0x0605) RUN	Setting AO as the FM output lower limit	V/F SVC FVC PMVF PMSVC PMFVC Set AO as the lower limit of the frequency output.	0.20kHz (0.00kHz~100.00kHz)

◇ F06.06: Setting AO as the FM Output Upper Limit

Parameter Code (Address)	Name	Description	Default (Range)
F06.06 (0x0606) RUN	Setting AO as the FM output upper limit	V/F SVC FVC PMVF PMSVC PMFVC Set AO as the upper limit of the frequency output.	50.00kHz (0.00kHz~100.00kHz)

Group F06.1x: Expanded AO

The expanded AO parameter should be used with an option card (IO extension card).

◇ F06.10: Expanded AO Mode Selection

Parameter Code (Address)	Name	Description	Default (Range)
F06.10 (0x060A) RUN	Expanded AO mode selection	V/F SVC FVC PMVF PMSVC PMFVC Set the form of AO signals. 0: 0~10 V mode 1: 4.00~20.00 mA mode 2: 0.00~20.00 mA mode	0 (0~2)

◇ F06.11: Expanded AO Quantity Selection

Parameter Code (Address)	Name	Description	Default (Range)
F06.11 (0x060B) RUN	Expanded AO quantity selection	V/F SVC FVC PMVF PMSVC PMFVC Set the AO quantity. The same as F06.01.	1 (0~19)

◇ F06.12: Expanded AO Gain

Parameter Code (Address)	Name	Description	Default (Range)
F06.12 (0x060C) RUN	Expanded AO gain	V/F SVC FVC PMVF PMSVC PMFVC Set the AO gain.	100.0% (0.0%~300.0%)

◇ **F06.13: Expanded AO Bias**

Parameter Code (Address)	Name	Description	Default (Range)
F06.13 (0x060D) RUN	Expanded bias AO	V/F SVC FVC PMVF PMSVC PMFVC Set the bias of AO signals.	0.0% (-10.0%~10.0%)

◇ **F06.14: Expanded AO Filter**

Parameter Code (Address)	Name	Description	Default (Range)
F06.14 (0x060E) RUN	Expanded filter AO	V/F SVC FVC PMVF PMSVC PMFVC Sets the filter time of analog output signal.	0.010s (0.000s~6.000s)

Group F06.2x~F06.3x: Multi-functional Output Terminals

The inverter includes one digital output and one relay output, and additional one digital output and one relay output can be expanded through an option card.

Code	Name	Default	Function
F06.21	Output terminal Y.	1	Running.
F06.22	Relay 1 output (TA-TB-TC).	4	Failing.
F06.23	extension output terminal Y1.	0	No output.
F06.24	extension relay 2 output (TA-TB-TC).	0	No output.

Please refer to the table below to set the functions of F06.0x [Function Selection of Multi-functional Output Terminals].

Set Point	Function	Reference Description
0	No output.	Inactive terminal.
1	Inverter running	Judge the output according to the running state of the inverter.
2	Inverter reverse running	
3	Inverter forward running	
4	Fault trip alert 2 (no alert during fault self-recovery)	
5	Fault trip alert 2 (no alert during fault self-recovery)	
6	External fault stop	
7	Inverter undervoltage	Reserved
8	Inverter running preparation completed	Reserved
9	Output frequency detection test 1 (FDT1)	Reserved
10	Output frequency detection test 2 (FDT2)	Reserved
11	Set frequency reached	Reserved
12	Zero-speed running	Reserved

13	Upper frequency limit reached	Reserved
14	Lower frequency limit reached	Reserved
15	Program run cycle completed	Reserved
16	Program run phase completed	Reserved
17	PID feedback upper limit reached	Refer to the description of parameter F13.27.
18	PID feedback lower limit unreached	Refer to the description of parameter F13.28.
19	PID feedback sensor wire broken	Refer to the description of parameter F13.25.
20	Meter length reached	Reserved
21	Timer's set time reached	Reserved
22	Counter's maximum reached	Reserved
23	Counter's set point reached	Reserved
24	Dynamic braking	For the initial voltage of dynamic brake, refer to the description of parameter F10.15.
25	Reserved	
26	Emergency stopping	
27	Overload warning output 1	Refer to the description of parameter F10.32.
28	Underload warning output 2	Refer to the description of parameter F10.32.
29	Inverter warning	
30	Output controlled by communication address 0x3018	Refer to the table below.
31	Inverter overheat warning	Refer to the description of parameter F10.25.
32-36	Reserved	
37	Comparator 1	Refer to F06.4x monitoring parameter comparator output 1
38	Comparator 2	Refer to F06.4x monitoring parameter comparator output 2
39	Reserved	
40-47	Use of industry application extension.	
48-63	Use of option card.	

Function selection of Modbus RS485 communication to control multi-functional output

Set values of BIT0 - BIT3 (corresponding to output terminals of the controller) in communication address 0x3018. The specific corresponding relationship is as follows:

Communication Address	Name
0x3018	BIT0: Output terminal Y.
	BIT1: Relay 1 output (TA-TB-TC).
	BIT2: extension output terminal Y1.
	BIT3: extension relay 2 output (TA-TB-TC).

◇ F06.20: Polarity Selection of Multi-functional Output Terminal

Parameter Code (Address)	Name	Description	Default (Range)
F06.20 (0x0614) RUN	Function selection of output terminal Y	V/F SVC FVC PMVF PMSVC PMFVC Set the function of multi-functional output terminal Y.	0000 (0000~1111)

LED"0": Y terminal

0: Positive polarity, output terminal Y is at low level when Valid, and normally open in an equivalent circuit.

1: Negative polarity, output terminal Y does not output when Valid, and normally open in an equivalent circuit.

LED"00": Relay 1 output terminal

0: Positive polarity, TA-TC is normally open, while TB-TC is normally close.

1: Negative polarity, TA-TC is normally close, while TB-TC is normally open.

LED"000": extension terminal Y

0: Positive polarity, output terminal Y is at low level when Valid, and normally open in an equivalent circuit.

1: Negative polarity, output terminal Y does not output when Valid, and normally open in an equivalent circuit.

LED"0000": Relay 2 output terminal

0: Positive polarity, TA 1-TC 1 is normally open, while TB 1-TC 1 is normally closed.

1: Negative polarity, TA 1-TC 1 is normally closed, while TB 1-TC 1 is normally open.

◇ F06.21: Function Selection of Output Terminal Y

Parameter Code (Address)	Name	Description	Default (Range)
F06.21 (0x0615) RUN	Function selection of output terminal Y	V/F SVC FVC PMVF PMSVC PMFVC Set the function of multi-functional output terminal Y.	1 (0~63)

◇ F06.22: Function Selection of Relay 1

Parameter Code (Address)	Name	Description	Default (Range)
F06.22 (0x0616) RUN	Function selection of relay 1	V/F SVC FVC PMVF PMSVC PMFVC Set the function of the multi-functional output terminal of the relay.	4 (0~63)

Note: When the function of the relay terminal is selected as invalid, TB-TC is normally closed and TA-TC is normally open.

◇ F06.23: Function Selection of Extension Output Terminal Y

Parameter Code (Address)	Name	Description	Default (Range)
F06.23 (0x0617) RUN	Function selection of extension output terminal Y	V/F SVC FVC PMVF PMSVC PMFVC Set the function of multi-functional extension output terminal Y.	0 (0~63)

◇ F06.24: Function Selection of Extension Relay 2

Parameter Code (Address)	Name	Description	Default (Range)
F06.24 (0x0618) RUN	Function selection of extension relay 2	V/F SVC FVC PMVF PMSVC PMFVC Sets the function of multi-functional extension output relay 2.	0 (0~63)

Multi-functional output set point

0: No output

It indicates that the terminal is Invalid. If the terminal function is idle, it is recommended to set it to 0 to prevent malfunction.

1: Inverter running

When the inverter is running, the output terminal will output an activation signal.

2: Inverter reverse running

When the inverter is operating reversely, the output terminal will output an activation signal.

3: Inverter forward running

When the inverter is running forward, the output terminal will output an activation signal.

4: Fault trip alert 1 (alert during fault self-recovery)

The output terminal will output signals during a fault of the inverter, including the fault self-recovery period.

5: Fault trip alert 2 (no alert during fault self-recovery)

The output terminal will output signals during a fault of the inverter, excluding the fault self-recovery period.

6: External fault stop

When the multi-functional input terminal inputs an external fault signal and the inverter reports the external fault E.EF, the output terminal will output an activation signal.

7: Inverter under-voltage

The output terminal will output an activation signal during under-voltage of the inverter.

8: Inverter running preparation completed

When this signal is Valid, it indicates that the inverter has no fault, the bus voltage is normal, the running disabling terminals such as emergency stop are Invalid, and the inverter can run after accepting the Start command.

9: Output frequency detection test 1 (FDT1)

When the output frequency of the inverter exceeds the set point of F06.40 [Frequency Detection Value 1], the output terminal will output an activation signal. When the output frequency is lower than the detection level, the output terminal will output a deactivation signal after the hysteresis frequency set by F06.41 [Frequency Detection Range 1]. Refer to parameters F06.40 [Frequency Detection Value 1] and F06.41 [Frequency Detection Range 1] for detailed description.

10: Output frequency detection test 2 (FDT2)

When the output frequency of inverter exceeds the set point of F06.42 [Frequency Detection Value 2], the output terminal will output an activation signal. When the output frequency is lower than the detection level, the output terminal will output a deactivation signal after the hysteresis frequency set by F06.43 [Frequency Detection Range 2]. Refer to parameters F06.42 [Frequency Detection Value 2] and F06.43 [Frequency Detection Range 2] for detailed description.

11: Set frequency reached

When the output frequency of the inverter approaches or reaches the set frequency range (the range is determined by parameter F06.44 [Detection Range for the Set Frequency Reached]), the output terminal will output an activation signal, otherwise it will output a deactivation signal. Refer to F06.44 [Detection Range for the Set Frequency Reached] for detailed description.

12: Zero-speed running

When the inverter is running with output of 0.00 Hz, the output terminal will output an activation signal.

13: Upper frequency limit reached

When the inverter is running at the upper limit frequency, the output terminal will output an activation signal.

14: Lower frequency limit reached

When the inverter is running at the lower limit frequency, the output terminal will output an activation signal.

15: Program run cycle completed

When the program ends a cycle, the output terminal will output an activation signal of 500 ms.

16: The program run phase completed

When the program ends a phase, the output terminal will output an activation signal of 500 ms.

17: PID feedback upper limit reached

When the PID feedback is detected to reach F13.27 [disconnection Alarm Upper Limit] and the feedback signal keeps exceeding the limit after F13.26 [Feedback disconnection Detection Time], the output terminal will output an activation signal.

18: PID feedback lower limit unreached

When the PID feedback is detected to reach F13.28 [disconnection Alarm Lower Limit] and the feedback signal keeps exceeding the limit after F13.26 [Feedback disconnection Detection Time], the output terminal will output an activation signal.

19: PID feedback sensor wire broken

When the PID feedback sensor is detected to have a broken wire, the output terminal will output an activation signal. Refer to parameters F13.26 - F13.28 [Feedback disconnection Detection Time], [disconnection Alarm Upper Limit], and [disconnection Alarm Lower Limit].

20: Reserved**21: Timer's set time reached**

When the set time of internal timer of inverter is reached, the output terminal will output a valid pulse signal with a width of 1 s. Refer to parameters F08.07 [Timer Time Unit] and F08.08 [Timer Set Point].

22: Counter's maximum reached

When the counter's maximum value is reached, the output terminal will output an activation signal with a width equal to the external clock cycle, and the counter will be reset. Refer to parameter F08.02 [Counter Maximum Value].

23: Counter's set point reached

When the counter's set point is reached, the output terminal will output an activation signal. Then the counter will continue to count until it is reset after reaching the maximum value, the output activation signal is canceled. Refer to parameter F08.03 [Counter Set Point].

24: Dynamic braking

When the inverter meets the dynamic brake conditions, the output terminal will output an activation signal. Refer to parameter F10.14 [Dynamic Brake Enabling] for more details.

25: Reserved**26: Emergency stopping**

When the inverter stops for emergency, the output terminal will output an activation signal.

27: Overload warning detection 1

When the inverter is running under the V/F control mode, the motor output current will be used as the load warning judgment value; when the inverter is running under the vector control mode, the motor output torque will be used as the load warning judgment value. Then the inverter will compare the load warning judgment value with the load warning detection level to determine whether to output an activation signal. Refer to parameters F10.32 - F10.36 [Load Warning Detection Setting], [Load Warning Detection Level 1], [Load Warning Detection Time 1], [Load Warning Detection Level 2], and [Load Warning Detection Time 2].

28: Under-load warning detection 2

When the inverter is running under the V/F control mode, the motor output current will be used as the load warning judgment value; when the inverter is running under the vector control mode, the motor output torque will be used as the load warning judgment value. Then the inverter will compare the load warning judgment value with the load warning detection level to determine whether to output an activation signal. Refer to parameters F10.32 - F10.36 [Load Warning Detection Setting], [Load Warning Detection Level 1], [Load Warning Detection Time 1], [Load Warning Detection Level 2], and [Load Warning Detection Time 2].

29: Reserved

30: RS485 communication setting

After setting through RS485 communication (0x3018/0x2018), BIT0 corresponds to Y output, BIT1 corresponds to relay 1 output, and BIT2 corresponds to rely 2 output.

31: Inverter overheat warning

When the temperature of inverter reaches F10.25 [Inverter Overheat oH1 Warning Detection Level], the output terminal will output an activation signal.

33-36: Reserved

37: Comparator 1

When the value of the monitor item set by F06.50 [Comparator 1 Monitor Selection] is between F06.51 [Comparator 1 Upper Limit] and F06.52 [Comparator 1 Lower Limit], the output terminal will output an activation signal.

38: Comparator 2

When the value of the monitor item set by F06.55 [Comparator 2 Monitor Selection] is between F06.56 [Comparator 2 Upper Limit] and F06.57 [Comparator 2 Lower Limit], the output terminal will output an activation signal.

39-63: Reserved

◇ F06.25 - F06.32: Multi-functional output terminal delay time

Parameter Code (Address)	Name	Description	Default (Range)
F06.25 (0x0619) RUN	Terminal Y ON delay time	V/F SVC FVC PMVF PMSVC PMFVC Set the delay time for terminal Y to switch from OFF to ON.	0.010s (0.000s~60.000s)
F06.26 (0x061A) RUN	Relay 1 terminal ON delay time	V/F SVC FVC PMVF PMSVC PMFVC Set the delay time for terminal Y to switch from OFF to ON.	0.010s (0.000s~60.000s)
F06.27 (0x061B) RUN	extension terminal Y ON delay time	V/F SVC FVC PMVF PMSVC PMFVC Set the delay time for terminal Y to switch from OFF to ON.	0.010s (0.000s~60.000s)
F06.28 (0x061C) RUN	Relay 2 terminal ON delay time	V/F SVC FVC PMVF PMSVC PMFVC Set the delay time for terminal Y to switch from OFF to ON.	0.010s (0.000s~60.000s)
F06.29 (0x061D) RUN	Terminal Y OFF delay time	V/F SVC FVC PMVF PMSVC PMFVC Set the delay time for terminal Y to switch from ON to OFF.	0.010s (0.000s~60.000s)
F06.30 (0x061E) RUN	Relay 1 terminal OFF delay time	V/F SVC FVC PMVF PMSVC PMFVC Set the delay time for terminal Y to switch from ON to OFF.	0.010s (0.000s~60.000s)
F06.31 (0x061F) RUN	extension terminal Y OFF delay time	V/F SVC FVC PMVF PMSVC PMFVC Set the delay time for terminal Y to switch from ON to OFF.	0.010s (0.000s~60.000s)
F06.32 (0x0620) RUN	extension relay 2 terminal OFF delay time	V/F SVC FVC PMVF PMSVC PMFVC Set the delay time for terminal Y to switch from ON to OFF.	0.010s (0.000s~60.000s)

Group F06.4x: Frequency Detection

Outputs frequency consistency and frequency reached signals to a multi-functional output terminal.

There are two groups of frequency detection judgment parameters in the inverter.

The output frequency detection is shown as follows:

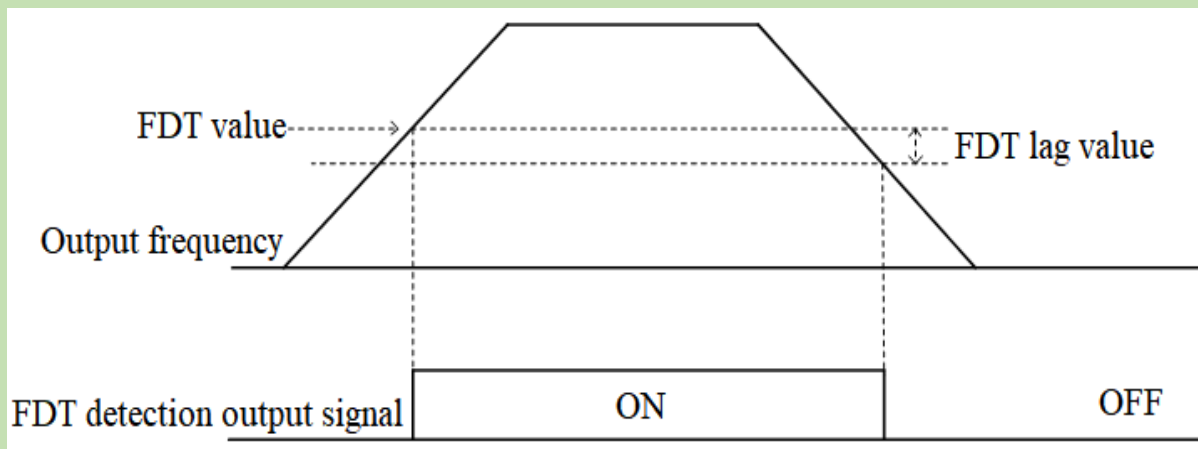

Schematic of Frequency Detection

◇ F06.40: Frequency Detection Value 1

Parameter Code (Address)	Name	Description	Default (Range)
F06.40 (0x0628) RUN	Frequency detection value 1	V/F SVC FVC PMVF PMSVC PMFVC Set frequency detection value 1.	2.00Hz (0.00Hz~F01.10)

Note:

- The frequency detection value is compared with the running frequency.

◇ F06.41: Frequency Detection Range 1

Parameter Code (Address)	Name	Description	Default (Range)
F06.41 (0x0629) RUN	Frequency detection range 1	V/F SVC FVC PMVF PMSVC PMFVC Set frequency detection range 1.	1.00Hz (0.00Hz~F01.10)

◇ F06.42: Frequency Detection Value 2

Parameter Code (Address)	Name	Description	Default (Range)
F06.42 (0x062A) RUN	Frequency detection value 2	V/F SVC FVC PMVF PMSVC PMFVC Set frequency detection value 2.	2.00Hz (0.00Hz~F01.10)

Note:

- The frequency detection value is compared with the running frequency.

◇ F06.43: Frequency Detection Range 2

Parameter Code (Address)	Name	Description	Default (Range)

F06.43 (0x062B) RUN	Frequency detection range 2	V/F SVC FVC PMVF PMSVC PMFVC Set frequency detection range 2.	1.00Hz (0.00Hz~F01.10)
---------------------------	--------------------------------	---	---------------------------

◇ **F06.44: Detection Range for the Set Frequency Reached**

Parameter Code (Address)	Name	Description	Default (Range)
F06.44 (0x062C) RUN	Detection range for the given frequency reached	V/F SVC FVC PMVF PMSVC PMFVC Set the detection range for the set frequency reached.	2.00Hz (0.00Hz~F01.10)

The output for the set frequency reached is shown as follows:

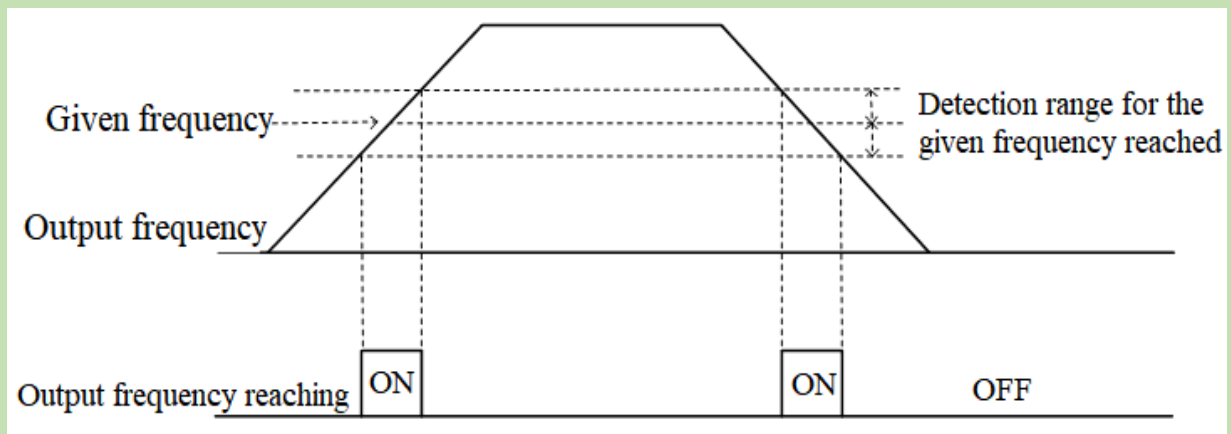

Schematic of Frequency Reaching Detection

Note:

- The frequency detection value is compared with the target frequency.

Group F06.5x: Monitoring Parameter Comparator Output

This group of parameters sets any monitoring parameter for comparator judgment, and selects multi-functional output terminal, warning or alert according to the judgment result, to meet the needs for the comparing the output of various monitoring variables.

F06.50 - F06.54: Comparator 1 (CP1)

Parameter Code (Address)	Name	Description	Default (Range)
F06.50 (0x0632) RUN	Comparator 1 monitor selection	V/F SVC FVC PMVF PMSVC PMFVC Select the parameter for comparator 1 to monitor. Ones and LED"00"s: Set yy in monitoring parameter number Cxx.yy Hundreds and LED"0000"s: Set xx in monitoring parameter number Cxx.yy	0001 (0000~0763)
F06.51 (0x0633) RUN	Comparator 1 upper limit	V/F SVC FVC PMVF PMSVC PMFVC Set the upper limit of comparator 1. The unit and the decimal place are determined by F06.50.	(Determined by F06.50)
F06.52 (0x0634) RUN	Comparator 1 lower limit	V/F SVC FVC PMVF PMSVC PMFVC Set the lower limit of comparator 1. The unit and the decimal place are determined by F06.50.	(Determined by F06.50)

F06.53 (0x0635) RUN	Comparator 1 bias	V/F SVC FVC PMVF PMSVC PMFVC Set the bias of comparator 1. The unit and the decimal place are determined by F06.50.	(Determined by F06.50)
F06.54 (0x0636) RUN	Comparator 1 action selection	V/F SVC FVC PMVF PMSVC PMFVC Select the action of comparator 1. 0: Continue running (digital terminal output only) 1: Alarm and free stop, E. CP1 2: Send a warning and keep running, A. CP1 3: Forced stop	0 (0~3)

Note:

- Comparator 1 action selection = 3:forced stop, the inverter internal gives the stop command, and shuts down by the set stop mode.

◇ **F06.55 - F06.59: Comparator 2 (CP2)**

Parameter Code (Address)	Name	Description	Default (Range)
F06.55 (0x0637) RUN	Comparator 2 monitor selection	V/F SVC FVC PMVF PMSVC PMFVC Select the parameter for comparator 2 to monitor. Ones and LED"00"s: Set yy in monitoring parameter number Cxx.yy Hundreds and LED"0000"s: Set xx in monitoring parameter number Cxx.yy	0002 (0000~0763)
F06.56 (0x0638) RUN	Comparator 2 upper limit	V/F SVC FVC PMVF PMSVC PMFVC Set the upper limit of comparator 2. The units and the decimal place are determined by F06.55.	(Determined by F06.55)
F06.57 (0x0639) RUN	Comparator 2 lower limit	V/F SVC FVC PMVF PMSVC PMFVC Set the lower limit of comparator 2. The units and the decimal place are determined by F06.55.	(Determined by F06.55)
F06.58 (0x063A) RUN	Comparator 2 bias	V/F SVC FVC PMVF PMSVC PMFVC Set the bias of comparator 2. The units and the decimal place are determined by F06.55.	(Determined by F06.55)
F06.59 (0x063B) RUN	Comparator 2 action selection	V/F SVC FVC PMVF PMSVC PMFVC Set the action of comparator 2. 0: Continue running (digital terminal output only) 1: Alarm and free stop, E. CP2 2: Send a warning and keep running, A. CP2 3: Forced stop	0 (0~3)

Note:

- Comparator 2 action selection = 3: forced stop, the inverter internal gives the stop command, and shuts down by the set stop mode.

Group F06.6x: Virtual Input and Output Terminals

The virtual input and output function can achieve the following functions:

- Without external wiring connection, inputting the output result of the multi-functional output terminal to the multi-functional input terminal;
- Without external wiring connection, inputting the output of the multi-functional analog output terminal to the multi-functional analog input terminal.

Warning: Safety precautions for restarting the machine: Before the inverter trial operation, be sure to verify the setting points of parameters for the virtual input/output function. Without verification, unexpected actions of the inverter may cause personal accidents.

The virtual input/output function is based on the virtual wiring of the input/output terminals inside the inverter. Therefore, even if there is no physical wiring on the input/output terminals, the operation of the inverter may be different from the factory settings.

Note:

For more details about the virtual digital input set points, refer to F05.00 - F05.09 "set point of multi-functional contact input".

For more details about the virtual digital output set points, refer to F06.21 - F06.24 "set point of multi-functional output".

The output delay setting of virtual terminals vY1 - vY4 is the same as that of relay Refer to **[F06.25 - F06.32] for detailed description.**

The virtual terminals are characterized by the combination of vX_i and vY_i. To use the output signal of terminal Y as the input signal of terminal X, connect the internal vX_i to vY_i virtually, so as save the actual terminals X and Y for other use.

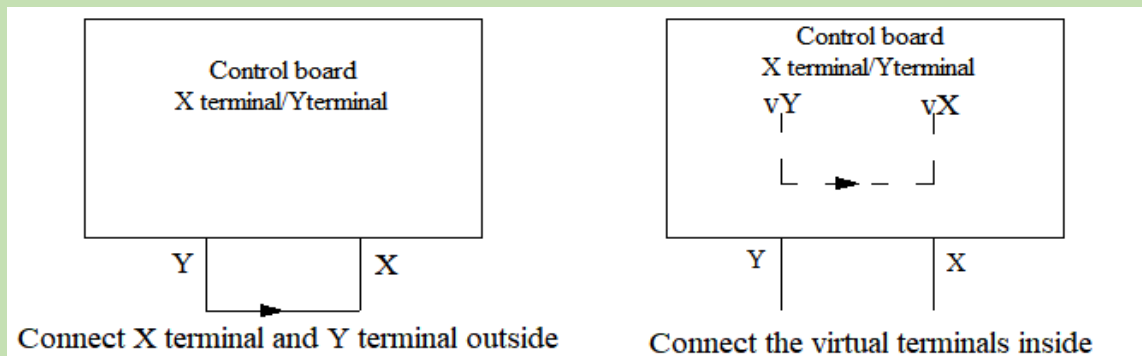

The following examples illustrate the applications of virtual vX and vY:

Example 1: In some situations, the inverter is required to run as soon as the initialization is completed after power-on, and generally a terminal X is used as the input. However, if you use the virtual terminal, you can save the actual terminal X for other input use. The specific operation method is as follows:

Set F01.01 = 1, terminal control as the run command source;

Set F05.20 = 0, 2-wire control 1;

Set F06.60 = 1, terminal input forward running;

Set F06.64 = 0000, the activation state of vX1 is determined by vY1;

Set F06.66 = 8, inverter output after it is ready to run.

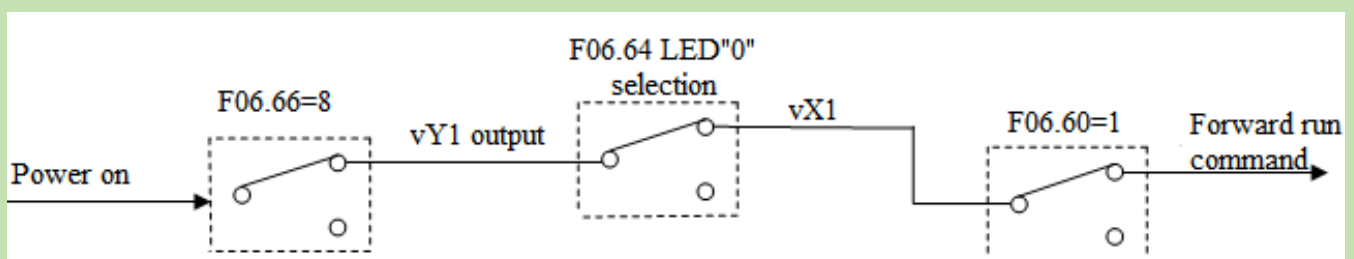

Schematic of Power-on Automatic Running Controlled by Virtual Terminal

◇ **F06.60 - F06.63: Virtual Digital Quantity Input Setting**

Parameter Code (Address)	Name	Description	Default (Range)
F06.60 (0x063C) STOP	Function selection of virtual terminal vX1	V/F SVC FVC PMVF PMSVC PMFVC Refer to "Set Point of Multi-Functional Input" in F05.0x.	0 (0~95)
F06.61 (0x063D) STOP	Function selection of virtual terminal vX2	V/F SVC FVC PMVF PMSVC PMFVC Refer to "Set Point of Multi-Functional Input" in F05.0x.	0 (0~95)
F06.62 (0x063E) STOP	Function selection of virtual terminal vX3	V/F SVC FVC PMVF PMSVC PMFVC Refer to "Set Point of Multi-Functional Input" in F05.0x.	0 (0~95)
F06.63 (0x063F) STOP	Function selection of virtual terminal vX4	V/F SVC FVC PMVF PMSVC PMFVC Refer to "Set Point of Multi-Functional Input" in F05.0x.	0 (0~95)

Note:

- For more details about the virtual digital input set point, refer to "Set Point of Multi-Functional Input" in F05.0x.

◇ **F06.64: Activation State Source of Terminal vX**

Parameter Code (Address)	Name	Description	Default (Range)
F06.64 (0x0640) RUN	Activation state source of terminal vX	V/F SVC FVC PMVF PMSVC PMFVC Set the activation state source of terminal vX.	0000 (0000~2222)

The input states of virtual terminals vX1 - vX4 can be set in three ways, which are selected through **[F06.64]**:

When the states of vX1 - vX4 are selected to be connected to virtual terminals vY1 - vY4 internally, whether vX1 - vX4 are Valid depends on whether vY1 - vY4 outputs are Valid. vX1 - vY1, vX2 - vY2, vX3 - vY3, vX4 - vY4 are bounded one to one.

When the states of vX1 - vX4 are selected to be connected to physical terminals X1 - X4, whether vX1 - vX4 are Valid depends on whether X1 - X4 outputs are Valid.

When the states of vX1 - vX4 are selected to be set by function code, to activate terminals vX1 - vX4, set the state of the corresponding input terminals through the function code **[F06.65]** respectively.

LED"0": virtual vX1

- 0: Internally connected to virtual vY1
- 1: Connected to physical terminal X1
- 2: Whether the function code setting is Valid

LED"00": Virtual vX2

- 0: Internally connected to virtual vY2
- 1: Connected to physical terminal X2
- 2: Whether the function code setting is Valid

LED"000": Virtual vX3

- 0: Internally connected to virtual vY3

1: Connected to physical terminal X3

2: Whether the function code setting is Valid

LED"0000": Virtual vX4

0: Internally connected to virtual vY4

1: Connected to physical terminal X4

2: Whether the function code setting is Valid

◇ F06.65: Activation State of Function Code Setting for Virtual Terminal vX

Parameter Code (Address)	Name	Description	Default (Range)
F06.65 (0x0641) RUN	Activation state of function code setting for virtual terminal vX	V/F SVC FVC PMVF PMSVC PMFVC Set whether the function code setting for virtual terminal vX is Valid.	0000 (0000~1111)

LED"0": Virtual vX1

0: Invalid

1: Valid

LED"00": Virtual vX2

0: Invalid

1: Valid

LED"000": Virtual vX3

0: Invalid

1: Valid

LED"0000": Virtual vX4

0: Invalid

1: Valid

◇ F06.66 - F06.69: Virtual Digital Quantity Output Setting

Parameter Code (Address)	Name	Description	Default (Range)
F06.66 (0x0642) RUN	Virtual vY1 output selection	V/F SVC FVC PMVF PMSVC PMFVC Refer to "Set Point of Multi-Functional Output" in F06.2x.	0 (0~63)
F06.67 (0x0643) RUN	Virtual vY2 output selection	V/F SVC FVC PMVF PMSVC PMFVC Refer to "Set Point of Multi-Functional Output" in F06.2x.	0 (0~63)
F06.68 (0x0644) RUN	Virtual vY3 output selection	V/F SVC FVC PMVF PMSVC PMFVC Refer to "Set Point of Multi-Functional Output" in F06.2x.	0 (0~63)
F06.69 (0x0645) RUN	Virtual vY4 output selection	V/F SVC FVC PMVF PMSVC PMFVC Refer to "Set Point of Multi-Functional Output" in F06.2x.	0 (0~63)

Note:

- For more details about the set point of virtual digital quantity output, refer to "Set Point of Multi-Functional Output" in F06.2x.

◇ **F06.66 - F06.69: Virtual Digital Quantity Output Setting**

Parameter Code (Address)	Name	Description	Default (Range)
F06.70 (0x0646) RUN	vY1 output ON delay time	V/F SVC FVC PMVF PMSVC PMFVC Set the delay time taken by terminal vY1 from OFF to ON.	0.010s (0.000s~60.000s)
F06.71 (0x0647) RUN	vY2 output ON delay time	V/F SVC FVC PMVF PMSVC PMFVC Set the delay time taken by terminal vY2 from OFF to ON.	0.010s (0.000s~60.000s)
F06.72 (0x0648) RUN	vY3 output ON delay time	V/F SVC FVC PMVF PMSVC PMFVC Set the delay time taken by terminal vY3 from OFF to ON.	0.010s (0.000s~60.000s)
F06.73 (0x0649) RUN	vY4 output ON delay time	V/F SVC FVC PMVF PMSVC PMFVC Set the delay time taken by terminal vY4 from OFF to ON.	0.010s (0.000s~60.000s)
F06.74 (0x064A) RUN	vY1 output OFF delay time	V/F SVC FVC PMVF PMSVC PMFVC Set the delay time taken by terminal vY1 from ON to OFF.	0.010s (0.000s~60.000s)
F06.75 (0x064B) RUN	vY2 output OFF delay time	V/F SVC FVC PMVF PMSVC PMFVC Set the delay time taken by terminal vY2 from ON to OFF.	0.010s (0.000s~60.000s)
F06.76 (0x064C) RUN	vY3 output OFF delay time	V/F SVC FVC PMVF PMSVC PMFVC Set the delay time taken by terminal vY3 from ON to OFF.	0.010s (0.000s~60.000s)
F06.77 (0x064D) RUN	vY4 output OFF delay time	V/F SVC FVC PMVF PMSVC PMFVC Set the delay time taken by terminal vY4 from ON to OFF.	0.010s (0.000s~60.000s)

Note:

- For more details about the delay of virtual digital quantity output, refer to "Set Point of Multi-Functional Output" in F06.2x.

6.9 Group F07: Running Control

Group F07.0x: Start Control

The inverter can be started up by three modes: Start frequency mode, DC brake mode and speed tracking mode.

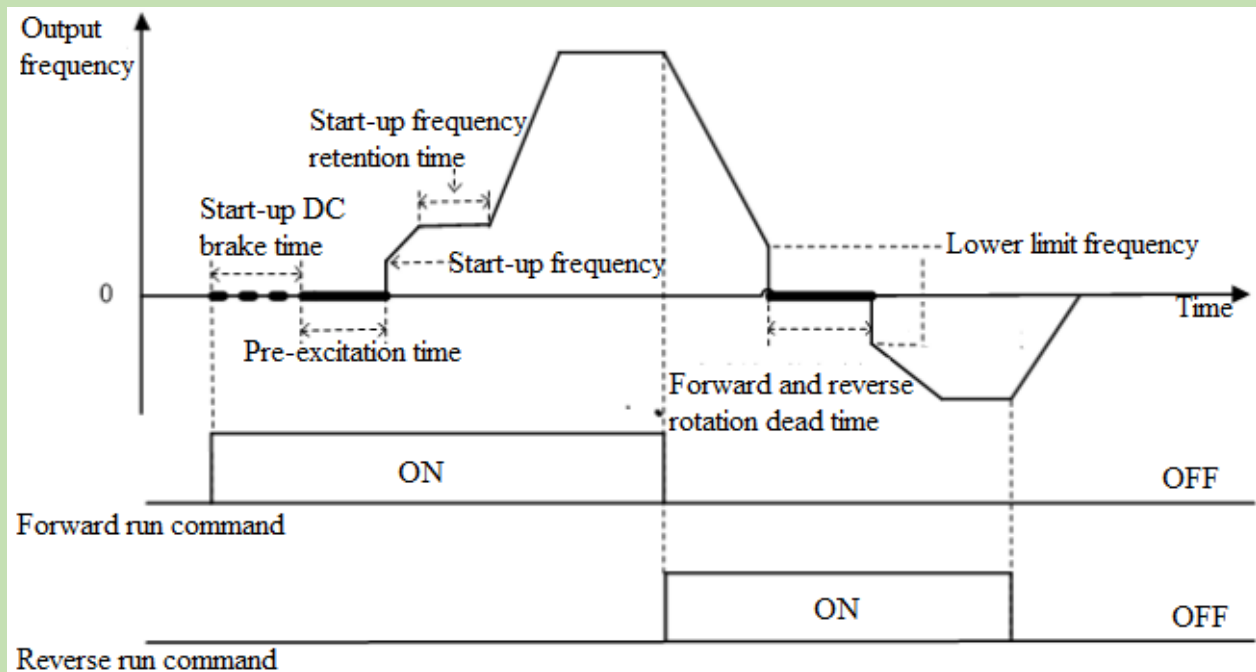

Schematic of Forward Start and Switching between Forward and Reverse Running

◇ F07.00: Start Modes

Parameter Code (Address)	Name	Description	Default (Range)
F07.00 (0x0700) STOP	Start mode	V/F SVC FVC PMVF PMSVC PMFVC Set the Start mode of the inverter.	0 (0~2)

0: Start by Start frequency

In this mode, the output frequency starts from F07.02 [Start Frequency] and changes with the set acceleration time.

1: Apply DC brake first and then start up as per the Start frequency

In this mode, the inverter will apply DC brake as per F07.20 [Start DC Brake Current] and F07.21 [DC Brake Time on Startup], and then start up as per the Start frequency. This mode applies to the scene that requires the motor speed is zero or low on startup. The inverter will apply a brake force to the motor, and then start up.

2: Start up after speed tracking and direction judgment

First detect the speed and direction of the motor, and then start up the inverter as per the detected speed. This mode applies to the scene that requires to start up the inverter after stop due to large inertia load.

Note:

- When the set frequency on startup is lower than F07.02 [Start Frequency], the inverter will stand by, with the running indicator on.

◇ F07.01: Start Pre-Excitation Time

Parameter Code (Address)	Name	Description	Default (Range)
F07.01 (0x0701) STOP	Start pre-excitation time	V/F SVC FVC PMVF PMSVC PMFV Establish a magnetic field before the motor starts, and set the pre-excitation time through this parameter.	0.00s (0.00s~60.00s)

Under the vector control of asynchronous motor, pre-excitation before startup can effectively improve the Start performance of the motor and reduce the Start current and time.

Note:

- This parameter is 0.00 s by default. The actual Start pre-excitation time is calculated automatically based on the motor parameters.
- When setting this parameter to a non 0.00 s, the Start pre-excitation time is the set point.

◇ F07.02: Start Frequency

Parameter Code (Address)	Name	Description	Default (Range)
F07.02 (0x0702) STOP	Start frequency	V/F SVC FVC PMVF PMSVC PMFVC On startup, the inverter will use this set point as the initial output frequency.	0.50Hz (0.00Hz~F01.12)

To ensure the motor output torque on startup, please set a proper output frequency. Over-current suppression or over-current fault will occur if this parameter is set too high.

Note:

- When the setting frequency is lower than the Start frequency, the inverter will stand by, with the running indicator light on.
- When the control mode is changed, the Default of F07.02 [Start Frequency] will be changed as follows.

Parameter	Control Mode	Defaults of F07.02 Start Frequency under Different Control Modes
F01.00	0: Asynchronous motor V/F control (V/F)	0.50Hz
	1: Asynchronous motor sensorless vector control (SVC)	0.50Hz
	2: Asynchronous motor flux vector control (FVC)	0.00Hz
	10: Synchronous motor V/F control (PMV/F)	0.50Hz
	11: Synchronous motor sensorless vector control (PMSVC)	0.50Hz
	12: Synchronous motor flux vector control (PMFVC)	0.00Hz

◇ F07.03: Start Protection Selection

Parameter Code (Address)	Name	Description	Default (Range)
F07.03 (0x0703) STOP	Start protection selection	V/F SVC FVC PMVF PMSVC PMFVC Select whether the set run command is Valid on startup.	0111 (0000~1111)

For convenience, the inverter states are divided into three: fault state, undervoltage state and standby state. The fault state and the undervoltage state are called abnormal states.

LED"0": Terminal Start protection in case of abnormal exit

0: OFF

1: ON

This function can be Valid only when the control mode is set as terminal control.

LED"00": Jogging terminal Start protection in case of abnormal exit

0: OFF

1: ON

LED"000": Start protection when the command channel is changed to terminal

0: OFF

1: ON

LED"0000": Reserved

Note:

- The Start protection is enabled by default when the free stop, emergency stop or forced stop command is Valid.
- After the terminal Start protection is Valid, the terminal run command should be eliminated first, and then the Start protection can be Valid after setting again.
- After the Start protection is Valid, if a run command is inputted, the inverter will not run and display the warning A.run3.

◇ F07.05: Rotation Direction Selection

Parameter Code (Address)	Name	Description	Default (Range)
F07.05 (0x0705) STOP	Rotation direction selection	V/F SVC FVC PMVF PMSVC PMFVC Select the direction of motor rotation.	0000 (0000~1121)

LED"0": Reverse running direction

0: Direction unchanged

If the actual direction of the motor is the same as the required direction, the motor will not change its direction;

1: Reverse direction

If the actual direction is contrary to the required direction, the motor direction will change it direction;

LED"00": Running direction disabled

Selects the activation state of the motor direction control.

0: Both forward and reserve commands are allowed

The inverter accepts both forward and reserve commands to control motor running;

1: Only forward command is allowed

The inverter only accepts forward commands to control motor running, and will not accept a reverse command.

2: Only reverse command is allowed

The inverter only accepts reverse commands to control motor operation, and will not accept a forward command.

LED"000": Frequency-based direction control selection

Selects whether the negative frequency is allowed to change the inverter running direction when the frequency setting point is negative.

0: Frequency-based direction control is Invalid

when the calculation result is negative, the inverter will output frequency of 0.00 Hz;

1: Frequency--based direction control is Valid

when the calculation result is negative, the inverter will

change the current running direction and output corresponding frequency.

Note:

- If the inverter is initialized through F00.03 [Initialization], the set point of this parameter will remain the same.
- If the parameters are downloaded through F00.04 [Download Parameters to the Inverter], the set point of this parameter at LED"0" will remain the same.
- When you need to set multiple inverters in a system with the same functional parameters by parameter copying, it is recommended not to calibrate the direction of the motor by reversing the running direction, but switch the three-phase output to two-phase output.

◇ F07.06 - F07.07: Restart Action upon Power Failure

Parameter Code (Address)	Name	Description	Default (Range)
F07.06 (0x0706) STOP	Selection of restart action upon power failure	V/F SVC FVC PMVF PMSVC PMFVC Select the function of restart action upon power failure.	0 (0~2)
F07.07 (0x0707) STOP	Waiting time for restart after power failure	V/F SVC FVC PMVF PMSVC PMFVC Set the standby time for restart action after power failure.	0.50s (0.00s~60.00s)

Selection of restart action upon power failure

0: Invalid After power failure, the inverter will not run again until it receives a run command.

1: Speed tracking startup If the inverter is running before the power failure, after the power is restored and after the time specified in F07.07 [Waiting Time for Restart after Power Failure], the inverter will automatically start up by speed tracking.

2: Start according to the Start mode

Waiting time for restart after power failure

The waiting time for restart after power failure should be set based on the working recovery time of other equipment related to the inverter after power supply is restored.

Note:

- During the waiting time for restart after power failure, the inverter does not accept any run command, but if you input a stop command during this time, the inverter will release the restart state.

Group F07.1x: Stop and Zero-Frequency Control

◇ F07.10: Stop Mode

Parameter Code (Address)	Name	Description	Default (Range)
F07.10 (0x070A) RUN	stop mode	V/F SVC FVC PMVF PMSVC PMFVC Select the stop mode of the inverter when the run release command or the input stop command is Valid.	0 (0~1)

Note: stop commands include the run release command and input stop command.

0: Deceleration stop

When the stop command is inputted, the motor will decelerate until stop.

The motor will decelerate until stop according to the Valid deceleration time. The factory set deceleration time is F01.21 [Deceleration Time 1]. The actual deceleration time varies with load conditions such as mechanical loss and inertia.

During the deceleration time, when the output frequency reaches or is lower than the set point of F07.22 [DC Brake Start Frequency], the inverter will enter the DC brake judgment during stop.

1: Free stop

When inputting the stop command, cut off the output of the inverter. Then the motor will free stop.

The motor will free stop at the deceleration rate formed by the load conditions such as mechanical loss and inertia.

When the deceleration mode is set as free stop, all the stop commands will be processed as free stop.

Note:

- After stop, the inverter will not respond to any run command during the time set by F07.12 [Minimum Time between stop and Restart].

◇ F07.11: Stop Detection Frequency

Parameter Code (Address)	Name	Description	Default (Range)
F07.11 (0x070B) RUN	stop detection frequency	V/F SVC FVC PMVF PMSVC PMFVC Set the frequency for judging whether the inverter enters the deceleration stop from the running state when the stop command is inputted. If the output frequency is less than the set point, the inverter will block output immediately and enter the stop state.	0.50Hz (0.00~F01.12)

When the inverter receives the stop command under the deceleration stop mode, if the DC brake function is valid, and the output frequency is less than F07.22 [DC Brake Start Frequency], the inverter will enter the stop DC brake state. If the output frequency is less than this set point, and the DC brake function is Invalid, the inverter will block output immediately and enter the stop state.

Note:

- Under F07.10 = 1 [stop mode = free stop], neither stop detection frequency judgment nor DC brake action is carried out.

◇ F07.12: Minimum Time between stop and Restart

Parameter Code (Address)	Name	Description	Default (Range)
F07.12 (0x070C) STOP	Minimum time between stop and restart	V/F SVC FVC PMVF PMSVC PMFVC Set the minimum time between the inverter switching from the running state to the stop state and accepting the run command.	0.000s (0.000s~60.000s)

The function is used when it is disallowed to frequently switch between startup and stop commands.

Note:

- During the minimum time between stop and restart, the inverter will not respond to any run command.

◇ F07.15: Selection of Action below Lower Frequency Limit

Parameter Code (Address)	Name	Description	Default (Range)
F07.15 (0x070F) RUN	Selection of action below lower frequency limit	V/F SVC FVC PMVF PMSVC PMFVC Set the action when the output frequency is below the lower limit frequency during running.	2 (0~3)

0: Run according to the frequency command

The inverter runs normally.

1: Enter the halt state and block the output.

When the set frequency and output frequency are less than or equal to the lower frequency limit, the inverter will block the output and enter the halt state, and the motor will free stop.

After entering the halt state, when the set frequency is greater than the lower frequency limit, the inverter will exit the halt state and enter the normal Start control.

2: Run at the lower frequency limit

When the set frequency and output frequency are less than or equal to the lower frequency limit, the inverter will output as per the lower frequency limit.

3: Run at zero speed

When the set frequency and output frequency are less than or equal to the lower frequency limit, the inverter will decelerate to zero frequency and enter zero-speed control (under FVC) or zero-speed torque function control (under SVC or V/F control).

After entering the zero-speed control, when the set frequency is greater than lower limit frequency, the inverter will exit the zero-speed control and enter the normal Start control.

Note:

- This function is active when there is a run command and the output frequency is less than the lower frequency limit, such as the forward/reverse over-zero state. It is inactive in the process of stop deceleration.
- When F07.10 = 1 [stop mode = free stop] and the stop command is Valid, the inverter will not make this function judgment.

◇ **F07.16 - F07.17 Zero-Speed Torque Retention**

Parameter Code (Address)	Name	Description	Default (Range)
F07.16 (0x0710) RUN	Zero-speed torque retention current	V/F SVC FVC PMVF PMSVC PMFVC 100.0% corresponds to the motor rated current, and the upper limit of the zero-speed torque current is the rated current of the inverter.	60.0% (0.0%~150.0%)
F07.17 (0x0711) RUN	Zero-Speed torque retention time	V/F SVC FVC PMVF PMSVC PMFVC Set the time of zero-speed torque retention function. The zero-speed torque is free of time limit when this parameter is set as 6000.0 s.	0.0s (0.0s~6000.0s)

Zero-speed torque retention current:

100.0% corresponds to the motor rated current, but the upper limit of the zero-speed torque current is the rated current of the inverter.

When the output frequency decelerates to F07.02 [Start Frequency], the inverter will enter zero-speed torque control state.

The value of zero-speed torque retention current will affect the magnetic field strength of the fixed motor shaft. Increasing the current value will increase the heat produced by the motor. Please set the minimum current value for the fixed motor shaft.

Zero-speed torque retention time:

Sets the time of zero-speed torque retention function. When the output frequency is less than F07.02 [Start Frequency], the inverter will start to count up the time.

Conditions for activating the zero-speed torque function:

Condition	Name
Control Mode	Vector control or V/F control mode.
Running state	Normal running state, non-stop deceleration.

Output frequency threshold	Less than F07.02 [Start Frequency], entering zero-speed running state.
----------------------------	--

◇ F07.18: Forward and Reverse Rotation Dead Time

Parameter Code (Address)	Name	Description	Default (Range)
F07.18 (0x0712) STOP	Forward and reverse rotation dead time	V/F SVC FVC PMVF PMSVC PMFVC Set the zero-frequency retention time in the case of switching between forward and reverse rotations.	0.0s (0.0s~120.0s)

When the inverter switches between forward and reverse commands, reaches the zero frequency and enters the forward and reverse rotation dead zone state, it will start to count up the time. After the inverter exits the forward and reverse dead zone state, the timer will be reset.

To exit the forward and reverse rotation dead zone state:

Exit Mode	Post-Exit Control Mode
Forward and reverse rotation dead time up	Enter normal Start control.
Reverse command	Enter normal Start control.
stop command	Enter stop control.

In forward and reverse rotation dead zone state:

Control Mode	Achieving Mode
SVC, V/F	When the zero-speed torque is active, the inverter will enter the zero-speed torque control state.
SVC, V/F	When the zero-speed torque is inactive, the output frequency and voltage will be zero.
FVC	Enter the zero-speed control.

Note:

- This function is used in the scene where needs to wait for a certain time at zero-speed for relevant process preparation.
- The forward and reverse rotation dead zone state does not conflict with the zero-speed torque retention function, and both of them count up the time from zero frequency.

Group F07.2x: DC Braking and Speed Tracking

◇ F07.20 - F07.21: Start DC Brake

Parameter Code (Address)	Name	Description	Default (Range)
F07.20 (0x0714) STOP	Start DC braking current	V/F SVC FVC PMVF PMSVC PMFVC 100.0% corresponds to the motor rated current, and the upper limit of braking current is the rated current of the inverter.	60.0% (0.0%~150.0%)
F07.21 (0x0715) STOP	DC braking time on startup	V/F SVC FVC PMVF PMSVC PMFVC Sets the retention time of DC braking on startup.	0.0s (0.0s~60.0s)

Note: This function can be valid when F07.00 = 1 [Start mode = applying DC braking first and then start up as per the Start frequency].

After the run command is valid, if the pre-excitation function is invalid, the inverter will enter the Start DC braking state; if the pre-excitation function is valid, the inverter will enter the Start DC braking state after the completing the

pre-excitation.

Start DC braking current

100.0% corresponds to the motor rated current, but the upper limit of Start DC braking current is the rated current of the inverter.

The DC braking current will affect the magnetic field strength of the fixed motor shaft. Increasing the current value will increase the heat produced by the motor. Please set the minimum current value for the fixed motor shaft.

DC braking time on startup:

After the run command is valid, if the pre-excitation function is invalid, the inverter will start to count up the time; if the pre-excitation function is valid, the inverter will start to count up the time after the completing the pre-excitation.

Note:

- To start the motor which is running freely, use the Start DC braking to stop the motor before starting it, or use the speed tracking to start the motor.

✧ F07.22 - F07.24: Shut-down DC Brake

Parameter Code (Address)	Name	Description	Default (Range)
F07.22 (0x0716) STOP	DC braking start frequency	V/F SVC FVC PMVF PMSVC PMFVC Set the threshold for the inverter to enter the stop DC braking.	1.00Hz (0.00Hz~50.00Hz)
F07.23 (0x0717) STOP	Stop DC braking current	V/F SVC FVC PMVF PMSVC PMFVC 100.0% corresponds to the motor rated current, and the upper limit of braking current is the rated current of the inverter.	60.0% (0.0%~150.0%)
F07.24 (0x0718) STOP	Stop DC braking time	V/F SVC FVC PMVF PMSVC PMFVC Set the retention time of DC braking during stop.	0.0s (0.0s~60.0s)

Note: Stop DC braking can be valid when F07.10 = 0[stop mode = deceleration stop].

Under the stop command, when the output frequency is less than F07.22 [DC Braking Start Frequency], the inverter will enter the stop DC braking state.

The inverter will enter the stop state after completing the stop DC braking.

If the inverter receives the run command in the process of stop DC braking, it will exit the stop DC braking state and enter the normal Start control.

Stop DC brake current

100.0% corresponds to the motor rated current, but the upper limit of stop DC braking current is the rated current of the inverter.

The DC braking current will affect the magnetic field strength of the fixed motor shaft. Increasing the current value will increase the heat produced by the motor. Please set the minimum current value for the fixed motor shaft.

DC braking time during stop:

The inverter will start to count up the time after entering the stop DC braking state; it will reset the time after exiting the stop DC braking state, and restart to count up the time at next time.

◇ **F07.25~F07.28: Speed Tracking**

Parameter Code (Address)	Name	Description	Default (Range)
F07.25 (0x0719) STOP	Speed tracking mode	V/F SVC FVC PMVF PMSVC PMFVC Set the speed tracking mode.	0000 (0000~1111)
F07.26 (0x071A)STOP	Speed tracking time	V/F SVC FVC PMVF PMSVC PMFVC Set the speed tracking time.	0.5s (0.0s~60.0s)
F07.27 (0x071B) STOP	Speed tracking stop delay	V/F SVC FVC PMVF PMSVC PMFVC Set the speed tracking stop delay.	1.00s (0.00s~60.00s)
F07.28 (0x071C) STOP	Speed tracking current	V/F SVC FVC PMVF PMSVC PMFVC Set the upper limit of speed tracking current.	120.0% (0.0%~400.0%)

Speed tracking mode:**LED"0": Search mode**

0: Search from maximum frequency

1: Search from stop frequency

LED"00": Reverse search selection

0: OFF

1: ON

LED"000": Search source

0: Software search

1: Hardware search

LED"0000": Reserved**Note:**

- This function valid when F07.00 = 2 [Start mode = speed tracking startup].
- After the reverse search is enabled, the motor may search for the reverse. Do not enable this function when reverse running is disallowed.

Speed tracking time:

During the inverter speed tracking startup, the shorter time the inverter takes to increase the output voltage to the normal voltage at the current speed, the faster the tracking process will be, but the higher impact current the tracking process produces. When the time is zero, the tracking speed is automatically controlled by the internal of the inverter.

Speed tracking stop delay:

After the output is cut off, the inverter will output voltage again to start the motor after a period of delay time, so as to minimize the impact current on startup. When the time is zero, the delay is automatically controlled by the internal of the inverter.

Group F07.3x: Jogging

◇ F07.30: Jogging Frequency

Parameter Code (Address)	Name	Description	Default (Range)
F07.30 (0x071E) RUN	Jogging frequency	V/F SVC FVC PMVF PMSVC PMFVC Set the frequency for jogging.	5.00Hz (0.00Hz~F01.10)

Note:

- Jogging command has a higher priority. If the jogging command is valid during running, the inverter will enter the jogging control directly.
- The set upper limit is subject to F01.10 [Maximum Frequency].

◇ F07.31 - F07.32 Jogging Acceleration/Deceleration Time

Parameter Code (Address)	Name	Description	Default (Range)
F07.31 (0x071F) RUN	Jogging acceleration time	V/F SVC FVC PMVF PMSVC PMFVC Set the time for the jogging output frequency to accelerate from 0 to the frequency selected by F01.20.	10.00s (0.01s~650.00s)
F07.32 (0x0720) RUN	Jogging deceleration time	V/F SVC FVC PMVF PMSVC PMFVC Set the time for the jogging output frequency to decelerate from the frequency selected by F01.20 to 0.	10.00s (0.01s~650.00s)

Note:

- F01.20 = 0, 1, 2 [Reference frequency for acceleration/deceleration time = maximum frequency, fixed frequency 50.00 Hz, set frequency].

◇ F07.33: Jogging S-curve Selection

Parameter Code (Address)	Name	Description	Default (Range)
F07.33 (0x0721) RUN	Jogging S-curve selection	V/F SVC FVC PMVF PMSVC PMFVC Sets whether the S-curve is Valid during jogging.	1 (0~1)

0: Invalid

1: Valid

Note:

- The time of jogging S-curve is the same as that of non-jogging S-curve. Both of them are F01.31 - F01.34.

◇ F07.34: Jogging Stop Mode

Parameter Code (Address)	Name	Description	Default (Range)
F07.34 (0x0722) RUN	Jogging stop mode	V/F SVC FVC PMVF PMSVC PMFVC Sets the jogging stop mode.	0 (0~1)

0: The same as the stop mode set by F07.10.

F07.10 = 0 [stop mode = deceleration stop];

F07.10 = 1 [stop mode = free stop].

1: Deceleration stop only

The stop mode is not affected by setting of F07.10, and is only deceleration stop.

Note:

- In the jogging deceleration stop only mode, the inverter neither enters the stop DC brake, nor enters the judgment of retention frequency during stop.
- The function of Start retention frequency is Invalid during jogging.
- The jogging frequency setting is not subject to the lower frequency limit.

Group F07.4x: Start and Stop Frequency Retention and Frequency Hopping

◇ F07.40~F07.43: Start and stop Frequency Retention

This function is used to retain the set output frequency temporarily on startup or stop.

This function can prevent the motor from stalling when starting or stopping under heavy load. Furthermore, this function also can avoid the shock caused by mechanical backlash at the beginning of acceleration and deceleration.

During acceleration, the inverter will automatically run at a low speed by the set output frequency and time to reduce the impact of backlash and then accelerate again. The same effect is achieved during deceleration.

For handling machinery, this function can be used to wait for the opening and closing delay of the electromagnetic brake on the mechanical or motor side according to the output frequency of the inverter.

Parameter Code (Address)	Name	Description	Default (Range)
F07.40 (0x0728) STOP	Start retention frequency	V/F SVC FVC PMVF PMSVC PMFVC Set the temporarily retained output frequency when the motor starts.	0.50Hz (0.00Hz~F01.12)
F07.41 (0x0729) STOP	Start frequency retention time	V/F SVC FVC PMVF PMSVC PMFVC Set the retention time of the temporary output frequency when the motor starts.	0.00s (0.00s~60.00s)

When the output frequency reaches the frequency set by F07.40 during the Start acceleration, the inverter will retain this frequency for the time set in F07.41, and then continue to accelerate.

Note:

- The function of Start retention frequency is Invalid during jogging.

Parameter Code (Address)	Name	Description	Default (Range)
F07.42 (0x072A) STOP	Stop retention frequency	V/F SVC FVC PMVF PMSVC PMFVC Set the temporarily retained output frequency when the motor starts.	0.50Hz (0.00Hz~F01.12)
F07.43 (0x072B) STOP	Stop frequency retention time	V/F SVC FVC PMVF PMSVC PMFVC Set the retention time of the temporary output frequency when the motor starts.	0.00s (0.00s~60.00s)

When the output frequency reaches the frequency set by F07.42 during the stop deceleration, the inverter will retain this frequency for the time set in F07.43, and then continue to decelerate.

Note:

- In the jogging deceleration stop only mode, the inverter neither enters the stop DC brake, nor enters the judgment of retention frequency during stop.
- ◇ **F07.44~F07.47: Hopping Frequency**

This function is used to set a dead zone for a specific frequency band. When a machine previously running at a constant speed is running at a variable speed, resonance may occur. To avoid the resonance caused by the natural vibration frequency of the mechanical system during running, it is necessary to hop specific frequency bands.

Hopping frequency can be set at 2 places at most. Set the central value of the frequency to hop through F07.44 and F07.46 [Hopping Frequency 1, 2], and set frequency amplitude through F07.45 and F07.47 [Hopping Frequency Amplitude 1, 2].

When the input frequency command is the same as or similar to the hopping frequency band, the inverter will change the frequency command automatically.

Make the motor accelerate or decelerate smoothly until the frequency command is beyond the range of the hopping frequency band. The acceleration/deceleration rate at this time is determined by the Valid set acceleration/deceleration time. When the frequency command is beyond of the range of the hopping frequency band, the inverter will change to run at a constant speed.

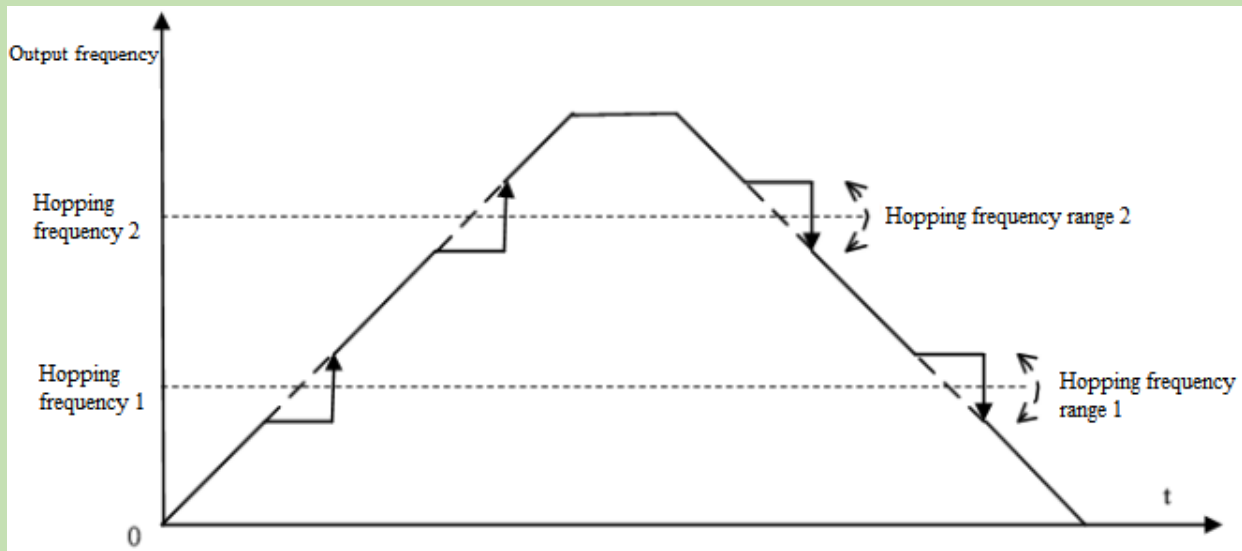

Schematic of Hopping Frequency Action

Parameter Code (Address)	Name	Description	Default (Range)
F07.44 (0x072C) RUN	Hopping frequency 1	V/F SVC FVC PMVF PMSVC PMFVC Set the central value of the specific frequency band to be hopped.	0.00Hz (0.00Hz~F01.10)
F07.45 (0x072D) RUN	Hopping frequency amplitude 1	V/F SVC FVC PMVF PMSVC PMFVC Set the amplitude of the specific frequency band to be hopped.	0.00Hz (0.00Hz~F01.10)

Note: When F07.44 [Hopping Frequency 1] is set to 0.00 Hz, hopping frequency 1 is Invalid.

Parameter Code (Address)	Name	Description	Default (Range)
F07.46 (0x072E) RUN	Hopping frequency 2	V/F SVC FVC PMVF PMSVC PMFVC Set the central value of the specific frequency band to be hopped.	0.00Hz (0.00Hz~F01.10)
F07.47 (0x072F) RUN	Hopping frequency amplitude 2	V/F SVC FVC PMVF PMSVC PMFVC Set the amplitude of the specific frequency band to be hopped.	0.00Hz (0.00Hz~F01.10)

Note:

➤ When F07.46 [Hopping Frequency 2] is set to 0.00 Hz, hopping frequency 2 is Invalid.

6.10 Group F08: Auxiliary Control 1

Group F08.0x: Counting and Timing

Counting

The relevant setting parameters for this function are shown as follows:

Parameter	Name	Default	Function
F05.0x	Multi-functional input terminal.	42	Counter signal input.
F05.0x	Multi-functional input terminal.	43	Count value reset.
F06.21~F06.24	Multi-functional output terminal.	22	Count value reaches maximum.
F06.21~F06.24	Multi-functional output terminal.	23	Count value reaches set point.
C00.22	Count value.		

◇ F08.00: Counter Input Source

Parameter Code (Address)	Name	Description	Default (Range)
F08.00 (0x0800) RUN	Counter input source	V/F SVC FVC PMVF PMSVC PMFVC Set the input source for the internal timer of the inverter.	0 (0~2)

0: Common multi-functional input terminals The frequency of input signal is less than 100 Hz.

1: Output terminal PUL The upper frequency limit of input signal is determined by the selection in F05.30.

2: Speed feedback card (PG card)

Note:

- When choosing different input sources, pay attention to the upper frequency limit of the signal.
- When F08.00 = 0, the input signal should be connected with the setting terminal of F05.0x = 42 [Multi-functional input terminal = counter input terminal].

◇ F08.01: Count Frequency Division

Parameter Code (Address)	Name	Description	Default (Range)
F08.01 (0x0801) RUN	Count frequency division	V/F SVC FVC PMVF PMSVC PMFVC Set the count frequency division value.	0 (0~6000)

The monitoring parameter C00.22 [Count value] is obtained by frequency division of the count signal.

Note:

- The values compared with F08.02 [Timer Maximum Value] and F08.03 [Timer Set Point] are both count values in C00.22.

◇ F08.02: Counter Maximum Value

Parameter Code (Address)	Name	Description	Default (Range)
F08.02 (0x0802) RUN	Counter maximum value	V/F SVC FVC PMVF PMSVC PMFVC Set the counter maximum value.	1000 (0~65000)

F06.21 - F06.24 = 22 [Multi-functional output terminal = Count value reaches maximum]. When the count value reaches the value set by F08.02, the corresponding output terminal will output an activation signal and reset the value of C00.22 to zero. The output signal width is equal to the clock period of the active signal of the external input terminal, that is, the output terminal will stop outputting the activation signal when the next count signal is inputted.

◇ F08.03: Counter Set Point

Parameter Code (Address)	Name	Description	Default (Range)
F08.03 (0x0803) RUN	Counter set point	V/F SVC FVC PMVF PMSVC PMFVC Set the counter set point.	500 (0~65000)

F06.21 - F06.24 = 23 [Multi-functional output terminal = Count value reaches the set point]. When the count value reaches the value set by F08.03, the corresponding output terminal will output an activation signal with a width of the value that the output signal exceeds the value specified in parameter F08.02, which causes the output terminal will not stop outputting the activation signal until the counter is reset.

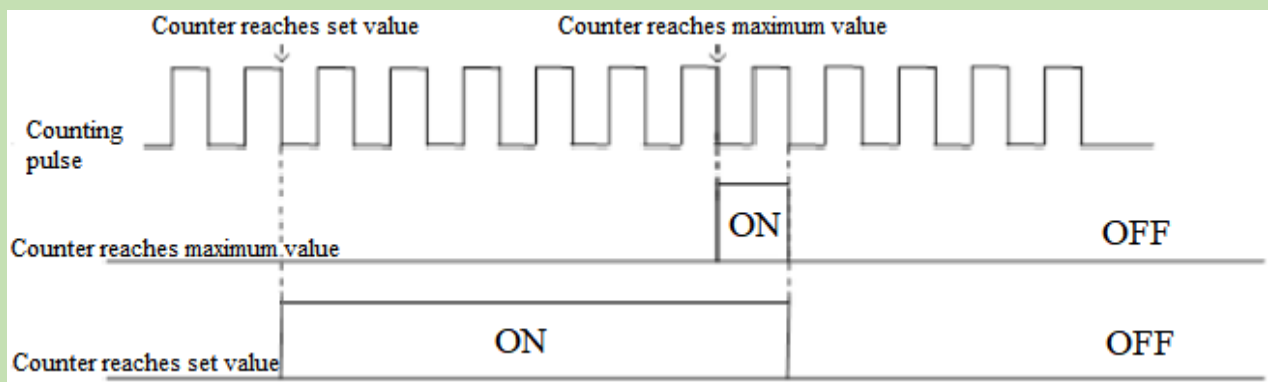

Schematic of Operations for Counter Maximum Value and Set Value

Note:

- The counter set point is required to be less than or equal to the timer maximum value.
- C00.22 count value can be reset by using the terminal set by F05.0x = 43 [Multi-functional input terminal = counter reset].

Fixed length control

F08.06 [Actual length] = C00.22/F08.04.

When F08.06 [Actual length] is longer than F08.05 [Set length], use output terminal to output an activation signal through F06.21 - F06.42 = 20 [Multi-functional output terminal = meter length reached], to perform stop control or next action start control.

◇ **F08.04: Number of Pulses per Meter**

Parameter Code (Address)	Name	Description	Default (Range)
F08.04 (0x0804) RUN	Number of pulses per meter	V/F SVC FVC PMVF PMSVC PMFVC Set the number of pulses per meter.	10.0 (0.1~6553.5)

◇ **F08.05: Set Length**

Parameter Code (Address)	Name	Description	Default (Range)
F08.05 (0x0805) STOP	Set length	V/F SVC FVC PMVF PMSVC PMFVC Set the set length.	1000m (0m~65535m)

Note:

➤ The range of set length should not exceed the calculated value of F08.02/F08.04.

◇ **F08.06: Actual Length**

Parameter Code (Address)	Name	Description	Default (Range)
F08.06 (0x0806) STOP	Actual length	V/F SVC FVC PMVF PMSVC PMFVC Set the actual length. This parameter is read only.	0m (0m~65535m)

Note: F08.06 [Actual Length] = C00.22/F08.04.

Timer

Timer starts to count up when the external trigger terminal receives the activation signal. After the set time is reached, the corresponding output terminal will output a pulse signal with a width of 1 s.

When the trigger terminal is Invalid, the timer will keep the current time value, and cumulate the time after the trigger terminal is Valid.

Timer reset terminal can reset the time at any time.

The relevant setting parameters for this function are shown as follows:

Parameter	Name	Default	Function
F05.0x	Multi-functional input terminal.	40	Timer triggered.
F05.0x	Multi-functional input terminal.	41	Timer reset.
F06.21~F06.24	Multi-functional output terminal.	21	Timer's set time reached.
C00.30	Timer's countup time.		

◇ **F08.07: Timer Time Unit**

Parameter Code (Address)	Name	Description	Default (Range)
--------------------------	------	-------------	-----------------

F08.07 (0x0807) STOP	Timer time unit	V/F SVC FVC PMVF PMSVC PMFVC Sets the timer time unit. 0: Second 1: Minute 2: Hour	0 (0~2)
----------------------------	-----------------	---	------------

◇ **F08.08: Timer Set Point**

Parameter Code (Address)	Name	Description	Default (Range)
F08.08 (0x0808) STOP	Timer set point	V/F SVC FVC PMVF PMSVC PMFVC Set the timer set point.	0 (0~65000)

Group F08.3x: Swing Frequency Control

Under swing frequency control, the inverter will make the output frequency change periodically as per the pre-set acceleration and deceleration time. This function is especially suitable for textile industry, or other systems that need to change the speed according to the different front and rear diameters of bobbin.

◇ **F08.30: Swing Frequency Control**

Parameter Code (Address)	Name	Description	Default (Range)
F08.30 (0x081E) STOP	Swing frequency control selection	V/F SVC FVC PMVF PMSVC PMFVC Select whether swing frequency control is valid. 0: OFF 1: ON	0 (0~1)

◇ **F08.31: Swing Frequency Amplitude Control Selection**

Parameter Code (Address)	Name	Description	Default (Range)
F08.31 (0x081F) STOP	Swing frequency amplitude control selection	V/F SVC FVC PMVF PMSVC PMFVC Select the control mode of swing frequency amplitude.	0000 (0000~0111)

LED"0": Start mode

0: Automatic

1: Manual setting by terminal

LED"00": Swing amplitude control

0: Relative to center frequency

1: Relative to maximum frequency

LED"000": Preset frequency enabling

0: Disabled

1: Enabled

LED"0000": Reserved

◇ **F08.32: Preset Swing Frequency**

Parameter Code (Address)	Name	Description	Default (Range)
F08.32 (0x0820)	Preset swing frequency	V/F SVC FVC PMVF PMSVC PMFVC Set the preset swing frequency.	0.00Hz (0.00Hz~F01.10)

◇ **F08.33: Preset Swing Frequency Waiting Time**

Parameter Code (Address)	Name	Description	Default (Range)
F08.33 (0x0821) STOP	Preset swing frequency waiting time	V/F SVC FVC PMVF PMSVC PMFVC Set the waiting time for the preset swing frequency.	0.0s (0.0s~3600.0s)

◇ **F08.34: Swing Frequency Amplitude**

Parameter Code (Address)	Name	Description	Default (Range)
F08.34 (0x0822) STOP	Swing frequency amplitude	V/F SVC FVC PMVF PMSVC PMFVC Set the swing frequency amplitude.	10.0% (0.0%~50.0%)

◇ **F08.35: Jump Frequency**

Parameter Code (Address)	Name	Description	Default (Range)
F08.35 (0x0823) STOP	Jump frequency	V/F SVC FVC PMVF PMSVC PMFVC Set the jump frequency.	10.0% (0.0%~50.0%)

◇ **F08.36: Triangular Wave Rise Time**

Parameter Code (Address)	Name	Description	Default (Range)
F08.36 (0x0824) STOP	Triangular wave rise time	V/F SVC FVC PMVF PMSVC PMFVC Set the rise time of triangular wave.	5.00s (0.0s~650.00s)

◇ **F08.37: Triangular Wave Drop Time**

Parameter Code (Address)	Name	Description	Default (Range)
F08.37 (0x0825) STOP	Triangular wave drop time	V/F SVC FVC PMVF PMSVC PMFVC Set the drop time of triangular wave.	5.00s (0.0s~650.00s)

Parameter Code (Address)	Name	Description	Default (Range)
F10.01 (0x0A01) RUN	Over-current suppression point	V/F SVC FVC PMVF PMSVC PMFVC Set the load current limiting level. 100% corresponds to the rated current of the inverter.	160.0% (0.0%~300.0%)

Sets the load current limiting level of the over-current suppression function. 100% corresponds to the rated current of the inverter. When the output current ratio is greater than this value, the over-current suppression function will be triggered.

Parameter Code (Address)	Name	Description	Default (Range)
F10.02 (0x0A02) RUN	Over-current suppression gain	V/F SVC FVC PMVF PMSVC PMFVC Set the response effect of over-current suppression. The higher the set point, the faster the response.	100.0% (0.0%~500.0%)

Sets the response speed of over-current suppression function.

Parameter Code (Address)	Name	Description	Default (Range)
F10.03 (0x0A03) STOP	Current protection setting 1	V/F SVC FVC PMVF PMSVC PMFVC Set whether the current-related protection function is enabled. LED"0": Cycle-by-cycle current limiting (CBC) 0: OFF 1: ON LED"00": OC protection interference suppression 0: Normal 1: Primary interference suppression 2: Secondary interference suppression LED"000": SC protection interference suppression 0: Normal 1: Primary interference suppression 2: Secondary interference suppression LED"0000": Reserved	0001 (0000~f221)

Sets whether the current-related protection function is enabled.

LED"0": Cycle-by-cycle current limiting (CBC)

Cycle-by-cycle current limiting function through hardware protection, to a certain extent can limit the rise of current to avoid the inverter from reporting overcurrent fault.

0: OFF

1: ON

LED"00": OC protection interference suppression

When this function is valid, the software judges the E. oC [Overcurrent fault], eliminates interference signals and only responds to real overcurrent signals. After the secondary interference suppression is enabled, all edge signal information will be filtered.

0: Normal

1: Primary interference suppression

2: Secondary interference suppression

Note: This function may delay the alarm time of overcurrent fault, please use it with caution.

LED"000": SC protection interference suppression

When the function is Valid, the software judges the E. SC [System fault], eliminates interference signals and only responds to real system fault signals. After the secondary interference suppression is enabled, all edge signal information will be filtered.

0: Normal

1: Primary interference suppression

2: Secondary interference suppression

Note: This function may delay the alarm time of system fault, please use it with caution.

LED"0000": Reserved◇ **F10.04 - F10.06: Current Imbalance Protection**

Parameter Code (Address)	Name	Description	Default (Range)
F10.04 (0x0A04) STOP	Current protection setting 2	V/F SVC FVC PMVF PMSVC PMFVC LED"0": Judgment for non-zero sum of three-phase current detection, output fault warning E. HAL. 0: OFF 1: ON LED"00": 3-phase current imbalance protection judgment, output fault warning E. oLF4. 0: OFF 1: ON	0001 (0000~0011)
F10.05 (0x0A05) STOP	Current imbalance judgment threshold	V/F SVC FVC PMVF PMSVC PMFVC Determines the existence of a current imbalance fault by comparing the ratio of the maximum phase to the minimum phase in the three-phase current with this set point. When the threshold is exceeded, the fault is reported after F10.06 filter time.	160% (0%~500%)
F10.06 (0x0A06) STOP	Current imbalance filter coefficient	V/F SVC FVC PMVF PMSVC PMFVC The parameter value should be increased at a site with strong current fluctuation.	2.0 (0.0~60.0)

Group F10.1x: Voltage Protection

Parameter Code (Address)	Name	Description	Default (Range)
F10.11 (0x0A0B) STOP	DC bus overvoltage suppression function	V/F SVC FVC PMVF PMSVC PMFVC Slows down or stops acceleration or deceleration to prevent overvoltage fault when the DC bus voltage is higher than the overvoltage suppression point. LED"0": overvoltage suppression function 0: OFF 1: ON LED"00": Over-excitation function 0: OFF 1: Valid only during deceleration 2: Valid during running	0011 (0000~0021)

LED"0": overvoltage suppression function

0: OFF

If the DC bus voltage is greater than the overvoltage suppression point, the output frequency is not adjusted, which may trigger E.OU [overvoltage fault].

1: ON

The overvoltage suppression function is active in operation, especially for eccentric load.

Note: The overvoltage suppression function is active in any control mode. When the regenerative load increases suddenly, even if the overvoltage suppression function is switched on, it is possible to report E. OU [overvoltage failure].

LED"00": Over-excitation function

0: OFF

Do not increase the excitation current during deceleration, and the over-excitation function is Invalid.

1: Valid only during deceleration

over-excitation deceleration increases the excitation current during deceleration. Setting the motor in the overexcited state to make the motor decelerate sharply by producing greater brake torque. This process is faster than the common deceleration stop.

2: Valid during running

Precautions for the use of over-excitation deceleration:

Do not use over-excitation deceleration function for the following purposes. It is recommended to connect the brake resistor.

- Frequent rapid deceleration
- Continuous regenerative load
- Low-inertia machines
- Machines that is disallowed for torque fluctuations

Parameter Code (Address)	Name	Description	Default (Range)
F10.12 (0x0A0C) STOP	DC bus overvoltage suppression point	V/F SVC FVC PMVF PMSVC PMFVC Set the DC bus voltage value that triggers the overvoltage suppression function.	T3: 750 V S2: 370 V (0 V - overvoltage point) T3 overvoltage point: 820 V S2 overvoltage point: 400 V

Note: The Default of this parameter depends on the inverter model.

When the DC bus voltage reaches or exceeds F10.12 [Bus overvoltage Suppression Point] during the running, the inverter will adjust the output frequency automatically to suppress the rise of bus voltage and avoid the inverter from jumping to E. ou [overvoltage fault]. The schematic of overvoltage suppression function is shown as follows.

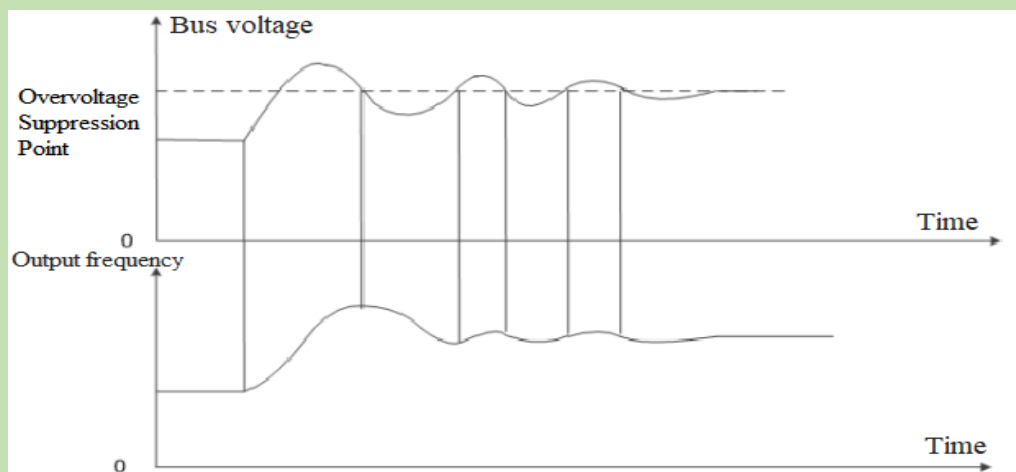

Schematic of Over-pressure Suppression Function

Parameter Code (Address)	Name	Description	Default (Range)
F10.13 (0x0A0D) RUN	DC bus overvoltage suppression gain	V/F SVC FVC PMVF PMSVC PMFVC Set the response effect of overvoltage suppression.	100.0% (0.0%~500.0%)

Adjust F10.13 [DC bus overvoltage Suppression Gain] to adjust the effect of over-pressure suppression function. When this parameter is set as 0, it indicates that the overvoltage suppression function is invalid.

Parameter Code (Address)	Name	Description	Default (Range)
F10.14 (0x0A0E) RUN	Dynamic brake enabling	V/F SVC FVC PMVF PMSVC PMFVC Set whether the dynamic brake function is enabled. 0: OFF 1: Enabled with overvoltage suppression disabled 2: Enabled with overvoltage suppression enabled	2 (0~2)

This parameter sets whether the dynamic brake function is enabled.

0: OFF

No matter how high the bus voltage, the inverter does not implement dynamic brake control for the motor.

1: Enable dynamic brake, and disable the overvoltage suppression function.

When the bus voltage exceeds the dynamic brake action voltage, the inverter will implement the dynamic brake control for the motor, and disable the overvoltage suppression function.

2: Enable dynamic brake and overvoltage suppression function at the same time.

When the bus voltage exceeds the dynamic brake action voltage, the inverter will implement dynamic brake control for the motor, and enable the overvoltage suppression function at the same time.

Note: In this parameter setting, the priority of turning on or turning off the overvoltage suppression function is above the F10.11 [Bus overvoltage Suppression Function].

Parameter Code (Address)	Name	Description	Default (Range)
F10.15 (0x0A0F) RUN	Dynamic brake action voltage	V/F SVC FVC PMVF PMSVC PMFVC Set the dynamic braking action voltage. The dynamic brake works when the bus voltage is higher than this value.	T3: 740 V S2: 360 V (0 V - overvoltage point) T3 overvoltage point: 820 V S2 overvoltage point: 400 V

When the DC bus voltage of the inverter increases and exceeds the F10.15 [Dynamic Braking Action Voltage], the inverter will start the dynamic brake action. For those models without built-in braking resistor, if you need to use dynamic brake function, please buy an optional brake resistor.

Note: When using the dynamic brake function, please disable the overvoltage suppression function and set F10.11 to 0. Otherwise, overvoltage suppression may inhibit the increase of bus voltage and fail to reach the dynamic brake action point.

Parameter Code (Address)	Name	Description	Default (Range)
F10.16 (0x0A10) STOP	DC bus under-voltage suppression function	V/F SVC FVC PMVF PMSVC PMFVC Limits the DC bus voltage decrease when the bus voltage is lower than the under-voltage suppression point by automatically adjusting the operating frequency to prevent under-voltage fault. 0: OFF 1: ON	0 (0~1)

Note: The overvoltage suppression function is active in any control mode.

When the DC bus voltage of the inverter reaches or is lower than F10.17 [DC Bus Under-voltage Suppression Point], the inverter will adjust output frequency automatically to suppress the reduction of DC bus voltage to ensure that the inverter does not trigger E. Lu2 [Under-voltage fault] due to low DC bus voltage.

0: OFF

1: ON

Parameter Code (Address)	Name	Description	Default (Range)
F10.17 (0x0A11) STOP	DC bus under-voltage suppression point	V/F SVC FVC PMVF PMSVC PMFVC Set the DC bus voltage value that triggers the under-voltage suppression function.	T3: 430 V S2: 240 V (0 V - overvoltage point) T3 overvoltage point: 820 V S2 overvoltage point: 400 V

Note: The Default of this parameter depends on the inverter model.

When the DC bus voltage of the inverter reaches or is lower than F10.17 [DC Bus Under-voltage Suppression Point], the inverter will adjust output frequency automatically to suppress the reduction of bus voltage to ensure that the inverter does not trigger E. Lu2 [Under-voltage fault] due to low DC bus voltage.

Parameter Code (Address)	Name	Description	Default (Range)
F10.18 (0x0A12) RUN	DC bus under-voltage suppression gain	V/F SVC FVC PMVF PMSVC PMFVC Sets the response effect of under-voltage suppression.	100.0% (0.0%~500.0%)

Adjust F10.18 [Bus Under-voltage Suppression Gain] to adjust the effect of under-voltage suppression function, When this parameter is set as 0, that indicates the under-voltage suppression function is turned off.

Parameter Code (Address)	Name	Description	Default (Range)
F10.19 (0x0A13) STOP	DC bus under-voltage protection point	V/F SVC FVC PMVF PMSVC PMFVC Sets the allowable lower limit of bus voltage. The inverter will report the under-voltage fault when the bus voltage is lower than this value.	T3: 320 V S2: 190 V (0 V - overvoltage point) T3 overvoltage point: 820 V S2 overvoltage point: 400 V

This parameter sets the lower voltage limit allowed by the DC bus voltage during the normal operation of the inverter. For some scenarios where the power grid is low, the under-voltage protection level can be appropriately reduced to ensure the normal operation of the inverter.

Note: When the grid voltage is too low, the output torque of the motor will reduce. For constant power load and constant torque load, when grid voltage is too low, the input and output current of the inverter will increase, thus reducing the operation reliability of the inverter.

Group F10.2x: Auxiliary Protection

Parameter Code (Address)	Name	Description	Default (Range)
F10.20 (0x0A14) STOP	Input and output phase loss protection selection	V/F SVC FVC PMVF PMSVC PMFVC Sets whether the input and output phase loss protection function is enabled. LED"0": Output phase loss protection function 0: OFF 1: ON LED"00": Input phase loss protection function 0: OFF 1: Enabled. The inverter reports alarm A. iLF and keep running when input phase loss is detected. 2: Enabled. The inverter reports alarm E. iLF and free stop when input phase loss is detected.	0021 (0000~1121)

Sets whether the input and output phase loss protection function is enabled.

LED"0": Output phase loss protection selection

0: OFF, output phase loss protection function is not active. This function cannot be turned off in the process of DC braking and vector pre-excitation.

1: ON, the function of output phase loss protection is active, when the output phase loss is detected, the fault E.oLF will be reported, the motor will free stop.

LED"00": Input phase loss protection selection

0: OFF, Input phase loss protection function is not active.

1: Enabled, when the input phase loss is detected, the fault A.iLF will be reported, the motor will keep running.

2: Enabled, when the input phase loss is detected, the fault E. iLF will be reported, the motor will free stop.

Parameter Code (Address)	Name	Description	Default (Range)
F10.21 (0x0A15) STOP	Input phase loss threshold	V/F SVC FVC PMVF PMSVC PMFVC Set the voltage detection percentage for the input phase loss detection function. 100% corresponds to the rated bus voltage.	10.0% (0.0%~30.0%)

Set the voltage detection percentage for the input phase loss detection function. 100% corresponds to the rated DC bus voltage.

Note: When the grid motor fluctuates greatly, the value can be increased appropriately to prevent false input phase loss warning.

Parameter Code (Address)	Name	Description	Default (Range)
F10.22 (0x0A16) STOP	Grounding short circuit protection selection	V/F SVC FVC PMVF PMSVC PMFVC Set whether the ground short circuit protection function for the inverter output and cooling fan is enabled. LED"0": Output short-to-ground protection function 0: Disabled 1: Detection upon power-on 2: Pre-running detection LED"00": Fan short-to-ground protection function 0: OFF 1: ON LED"000": Power short-to-ground protection function 0: OFF 1: ON	0111 (0000~0112)

Set whether the ground short circuit protection function for the inverter output and cooling fan is enabled.

LED"0": Output short-to-ground protection function

0: OFF, Output short-to-ground protection function is turned off.

1: Detection upon power-on, The output short-to-ground protection function is turned on, when the inverter outputs short circuit to ground is detected, the E. SG [Output short circuit to ground fault] will be reported.

2: Detection before operation, turn on the output short-to-ground protection function before operating at each time.

LED"00": Fan short-to-ground protection function

0: OFF, fan short-to-ground protection function is turned off.

1: ON, the fan short-to-ground protection function is turned on. When the fan short circuit to ground is detected, the E. FSG [Fan short circuit to ground fault] will be reported.

LED"000": Power short-to-ground protection function

0: OFF, power short-to-ground protection function is turned off.

1: ON, power short-to-ground protection function is turned on. When the power short circuit to ground is detected, the E. PoS [Power short circuit to ground fault] will be reported.

Note:

- When turning on the pre-running short-to-ground detection, the synchronous machine cannot be started in rotation.
- In the rotation process of the synchronous machine, the inverter will misreport short circuit to the ground fault after power-on.

Parameter Code (Address)	Name	Description	Default (Range)
--------------------------	------	-------------	-----------------

F10.23 (0x0A17) RUN	Fan ON/OFF control selection	V/F SVC FVC PMVF PMSVC PMFVC Set the running mode of the inverter's cooling fan. 0: The fan works after the inverter is powered on. 1: The fan runs according to the temperature after the inverter stop, and runs when the inverter is running. 2: After the inverter stop, the fan stops after the time set by F10.24, and runs according to the temperature.	1 (0~2)
---------------------------	---------------------------------	--	------------

Set the running mode of inverter cooling fan.

0: The fan runs after the inverter is powered on. Regardless of the module temperature, the fan will run after the inverter is powered on.

1: The fan runs according to the temperature after the inverter stop, and runs when the inverter is running. The fan runs according to the temperature when the inverter shuts down. If the temperature is above 50°C, the fan will run, otherwise it will stop after a delay time of 30 s. When the inverter is running, the fan will run after a delay time of 1 s.

2: After the inverter stop, the fan stops, and runs according to the temperature. The fan runs according to the temperature when the inverter is running. If the temperature is above 50°C, the fan will run immediately, otherwise it will stop after a delay time of 30 s. After the inverter stop, the fan will stop after a delay time of 30 s.

Note: Correct use of this function can effectively prolong the service life of the cooling fan.

Parameter Code (Address)	Name	Description	Default (Range)
F10.24 (0x0A18) STOP	Fan control delay time	V/F SVC FVC PMVF PMSVC PMFVC Set the time from releasing the deactivation command to stop of the cooling fan.	30.00s (0.00s~60.00s)

Sets the time from releasing the deactivation command to stopping of the cooling fan. After the inverter stops running, the fan will stop through this time.

Parameter Code (Address)	Name	Description	Default (Range)
F10.25 (0x0A19) RUN	Inverter overheat oH1 warning detection level	V/F SVC FVC PMVF PMSVC PMFVC Set the temperature value for overheat warning of the inverter. Overheat warning is Valid if the temperature is higher than this value.	80.0°C (0.0°C~100.0°C)

Sets the temperature value for overheat warning of inverter. A.OH1 [Overheat Warning] is Valid if the temperature of C00.12 radiator is higher than this value.

Parameter Code (Address)	Name	Description	Default (Range)
F10.26 (0x0A1A) RUN	Motor overheat protection selection (extension card)	V/F SVC FVC PMVF PMSVC PMFVC Set the motor overheat protection when an IO extension card is used. LED"0": Motor temperature sensor type 0: PT1000 1: KTY84	0x01 (0x00~0x01)

This parameter sets the motor overheat protection when an IO extension card is used.

LED"0": Motor temperature sensor type

0: PT1000, corresponding to the motor with PT1000 temperature sensor.

1:KTY84, corresponding to the motor with KTY84 temperature sensor.

Note: This function should be used with IO extension card, the type of motor temperature sensor should correspond with the motor temperature sensor.

F10.26 is active when the dip switch of IO extension card is set to KTY. The PT100 is active when the dip switch of IO extension card is set to PT100.

Parameter Code (Address)	Name	Description	Default (Range)
F10.27 (0x0A1B) RUN	Motor overheat alarm level (extension card)	V/F SVC FVC PMVF PMSVC PMFVC Set the temperature value of the motor for overheat fault. Overheat fault is reported if the temperature is higher than this value.	110.0°C (0.0°C~200.0°C)

Sets the temperature value of the motor for overheat fault, if the temperature is higher than this value, E.oH3 [Overheat fault] is reported if the temperature is higher than this value.

Parameter Code (Address)	Name	Description	Default (Range)
F10.28 (0x0A1C) RUN	Motor overheat warning level (extension card)	V/F SVC FVC PMVF PMSVC PMFVC Set the temperature value of the motor for overheat warning. Overheat warning is sent if the temperature is higher than this value.	90.0°C (0.0°C~F10.27)

Set the temperature value of the motor for overheat warning, if the temperature is higher than this value, A. oH3 [Overheat warning] is reported motor will continue to operate.

Group F10.3x: Load Detection Protection

Load detection judgment:

The load warning detection mode and the warning mode of the inverter should be used with two parameters of load detection level and load warning detection time.

Parameter Code (Address)	Name	Description	Default (Range)
F10.32 (0x0A20) STOP	Load warning detection setting	V/F SVC FVC PMVF PMSVC PMFVC Set the load warning detection mode and the warning mode of the inverter. LED"0": Load warning detection 1 setting 0: Do not detect 1: Detect overload 2: Detect overload only at constant speed 3: Detect underload 4: Detect underload only at constant speed LED"00": warning setting for load warning detection 1 0: Continue running and report A. LD1 1: free stop, and report E. LD1 LED"000": Load warning detection 2 setting 0: Do not detect 1: Detect overload 2: Detect overload only at constant speed 3: Detect underload 4: Detect underload only at constant speed LED"0000": Warning setting for load warning detection 2 0: Continue running and report A. LD2 1: Free stop, and report E. LD2	0000 (0000~1414)

Parameter Code (Address)	Name	Description	Default (Range)
F10.33 (0x0A21) STOP	Load warning detection level 1	V/F SVC FVC PMVF PMSVC PMFVC Set the detection value of load warning 1. Under V/F control, the value of 100% corresponds to the motor rated current. In the case of vector control, the value of 100% corresponds to the rated output torque of the motor	130.0% (0.0%~200.0%)
F10.34 (0x0A22) STOP	Load warning detection time 1	V/F SVC FVC PMVF PMSVC PMFVC Set the duration of detecting load warning 1. The load warning 1 will last for this time after the load reaches the detection level.	5.0s (0.0s~60.0s)

Set the related parameters of load warning 1.

When the inverter is running under the V/F control mode, 100.0% corresponds to the motor rated current. Under the vector control mode, motor output torque is used as load warning judgment value, and 100.0% corresponds to the rated output torque of the motor.

Load warning judgment value 1 in F10.34 [Load Warning Detection Time] should be compared with F10.33 [Load Warning Detection Level]. The motor will make corresponding action according to the set points in LED"0" and LED"00" of F10.32 [Load Warning Detection Setting].

When the function of terminal Y is selected as 27 [Overload warning detection] or 28 [Underload warning detection], the inverter will output warning signal through the terminal Y.

Parameter Code (Address)	Name	Description	Default (Range)
F10.35 (0x0A23) STOP	Load warning detection level 2	V/F SVC FVC PMVF PMSVC PMFVC Set the detection value of load warning 2. Under V/F control, the value of 100% corresponds to the motor rated current. In the case of vector control, the value of 100% corresponds to the rated output torque of the motor	30.0% (0.0%~200.0%)
F10.36 (0x0A24) STOP	Load warning detection time 2	V/F SVC FVC PMVF PMSVC PMFVC Set the duration of detecting load warning 2. The load warning 2 will last for this time after the load reaches the detection level.	5.0s (0.0s~60.0s)

Set the related parameters of load warning 2.

When the inverter is running under the V/F control mode, 100.0% corresponds to the motor rated current. Under the vector control mode, motor output torque is used as load warning judgment value, and 100.0% corresponds to the rated output torque of the motor.

Load warning judgment value 2 in F10.36 [Load Warning Detection Time] should be compared with F10.35 [Load Warning Detection Level]. The motor will make corresponding action according to the set points in LED"000" and LED"0000"s of F10.32 [Load Warning Detection Setting].

When the function of terminal Y is selected as 27 [Overload warning detection] or 28 [Underload warning detection], the inverter will output warning signal through the terminal Y.

Group F10.4x: Stall Protection

Parameter Code (Address)	Name	Description	Default (Range)
F10.40 (0x0A28) STOP	Protection against excessive speed deviation	V/F SVC FVC PMVF PMSVC PMFVC Set the warning detection when the deviation between the set speed and feedback speed of the motor is excessive. Select the warning detection mode and alarm mode. LED"0": Detection selection 0: Do not detect 1: Detect only at constant speed 2: Always detect LED"00": Alarm selection 0: Free stop and report fault 1: Alarm and keep running	0000 (0000~0012)

Set the warning detection mode and alarm mode when the deviation between the set speed and feedback speed of the motor is excessive, using it with F10.41 [Excessive Speed Deviation Detection Threshold] and F10.42 [Excessive Speed Deviation Detection Time].

LED"0": Detection selection

0: Do not detect, turn off the protection function for excessive speed deviation.

1: Detect only at constant speed, turn on the protection function for excessive speed deviation only when running at constant speed.

2: Always detect, turn on the protection function for excessive speed deviation when the motor is under the acceleration, deceleration and constant speed control.

LED"00": Fault selection

0: Free stop and report the fault alarm E.DEF

1: Continue running and report fault alarm A. DEF

Parameter Code (Address)	Name	Description	Default (Range)
F10.41 (0x0A29) STOP	Excessive speed deviation detection threshold	V/F SVC FVC PMVF PMSVC PMFVC Set the value for detecting excessive speed deviation. The value of 100% corresponds to F01.10 [Maximum frequency].	10.0% (0.0%~60.0%)
F10.42 (0x0A2A) STOP	Excessive speed deviation detection time	V/F SVC FVC PMVF PMSVC PMFVC Set the duration for detecting excessive speed deviation. If the deviation between the set speed and the feedback speed is greater than F10.41 and lasts for this time, the excessive speed deviation is detected and warning .	2.0s (0.0s~60.0s)

Note: The speed deviation detection threshold of 100% corresponds to F01.10 [Maximum Frequency].

When the deviation between the speed feedback value and the speed set point corresponding to the percentage value of F01.10 [Maximum Frequency] is greater than F10.41 [Excessive Speed Deviation Detection Threshold] within the set time of F10.42 [Excessive Speed Deviation Detection Time], the motor will respond according to F10.40 [Protection Against Excessive Speed Deviation].

Parameter Code (Address)	Name	Description	Default (Range)
F10.43 (0x0A2B) STOP	Speed Surge Protection	V/F SVC FVC PMVF PMSVC PMFVC Set the warning detection mode and alarm mode in the case of motor speed surge. LED"0": Detection selection 0: Do not detect 1: Detect only at constant speed 2: Always detect LED"00": Alarm selection 0: Free stop and report fault 1: Alarm and keep running	0002 (0000~0012)

Set the warning detection mode and alarm mode when the feedback speed of the motor is excessive, using it with F10.44 [Over-speed Detection Threshold] and F10.45 [Over-speed Detection Time].

LED"0": Detection selection

0: Do not detect, turn off the over-speed protection function.

1: Detect only at constant speed, turn on the protection function only when running at constant speed.

2: Always detect, turn on the over-speed protection function when the motor is under the acceleration, deceleration and constant speed control.

LED"00": Fault selection

0: Free stop and report the fault alarm E.SPD

1: Continue running and report fault alarm A. SPD

Parameter Code (Address)	Name	Description	Default (Range)
F10.44 (0x0A2C) STOP	Speed surge detection threshold	V/F SVC FVC PMVF PMSVC PMFVC Set the value for detecting speed surge. The value of 100% corresponds to F01.10 [Maximum frequency].	110.0% (0.0%~150.0%)

F10.45 (0x0A2D) STOP	Speed surge detection time	V/F SVC FVC PMVF PMSVC PMFVC Sets the duration for detecting speed surge. If the feedback speed is greater than F10.44 and lasts for this time, the speed surge is detected and warning .	0.100s (0.000s~2.000s)
----------------------------	-------------------------------	---	---------------------------

Note: The over-speed detection threshold of 100% corresponds to F01.10 [Maximum Frequency].

When the speed feedback value corresponding to the percentage value of F01.10 [Maximum Frequency] is greater than F10.44 [Over-speed Detection Threshold] within the setting time of F10.45 [Overs-peed Detection Time], the motor will make corresponding action according to F10.43 [Over-speed Protection Action].

Group F10.5x: Fault Recovery and Motor Overload

Fault Recovery F10.50~F10.52

When the inverter detects a temporary fault and does not want to stop the machine, the fault self-recovery function is used to reset the fault automatically. When the times of fault self-recovery exceeds the set point within the set time, the inverter will stop after detecting a fault. At this time, it is necessary to reset the fault manually after troubleshooting.

Dangerous! Do not use the fault self-recovery function when the winch lifting load or the fault cannot be automatically restored. Otherwise, that may result in personal injury accident.

Parameter Code (Address)	Name	Description	Default (Range)
F10.50 (0x0A32) STOP	Fault Self-Recovery Times Setting	V/F SVC FVC PMVF PMSVC PMFVC Set how many times fault self-recovery is allowed. Note: The value of 0 indicates that the fault self-recovery function is disabled, while any other value indicates that the function is enabled.	0 (0~10)

Note: When the parameter is set as 0, it indicates that the fault self-recovery function is disabled.

During the start of the fault self-recovery function, if the fault occurs in the process of shut-down deceleration, the fault self-recovery will not be performed.

During the start of the fault self-recovery function, if the undervoltage fault occurs during the operation, the inverter will jump to A. Lu1 warning and enter the stop state.

During the fault self-recovery, if the non-self-recovery fault occurs, the inverter will enter the fault state and not perform the self-recovery.

Parameter Code (Address)	Name	Description	Default (Range)
F10.51 (0x0A33) STOP	Fault self-recovery interval	V/F SVC FVC PMVF PMSVC PMFVC Set the waiting time between a fault of the inverter and the follow-up reset.	1.0s (0.0s~100.0s)

Sets the waiting time between a fault of the inverter and the follow-up reset. The Keypad will display the character of the fault in this time, but the running indicator light is still lighten.

Parameter Code (Address)	Name	Description	Default (Range)
F10.52 (0x0A34) READ	Times of Fault Recovery	V/F SVC FVC PMVF PMSVC PMFVC Indicates how many times fault self-recovery has been performed. This parameter is read only.	0

Indicates how many times fault self-recovery has been performed, it's convenient for user to confirm the usage state of the fault self-recovery function, this parameter is read only.

Note: Each time the fault self-recovery is executed, the value is increased by 1. When the value is equal to F10.50 [Fault Self-Recovery Times Setting], the fault will be detected if a self-recovery fault is triggered, and the fault recovery is no longer performed.

During the fault self-recovery, if the non-self-recovery fault results in the stop, the value will be reset to 0.

If the self-recovery fault occurs and other faults will not be triggered in 10 minutes, the value will be reset to 0.

Motor Overload Protection F10.55~F10.59

Parameter Code (Address)	Name	Description	Default (Range)
F10.55 (0x0A37) RUN	Motor Overload Model	V/F SVC FVC PMVF PMSVC PMFVC 0: Ordinary motor 1: Frequency conversion motor (50 Hz) 2: Frequency conversion motor (60 Hz) 3: Motor without cooling fan	0 (0~3)
F10.56 (0x0A38) STOP	Motor Insulation Class	V/F SVC FVC PMVF PMSVC PMFVC 0: Insulation class A 1: Insulation class E 2: Insulation class B 3: Insulation class F 4: Insulation class H 5: Special class S	3 (0~5)
F10.57 (0x0A39) STOP	Motor Working System	V/F SVC FVC PMVF PMSVC PMFVC 0-1: S1 working system (continuous working) 2: S2 working system 3-9: Corresponding to S3 - S9	0 (0~9)
F10.58 (0x0A3A) STOP	Motor Overload Start Threshold	V/F SVC FVC PMVF PMSVC PMFVC The starting threshold of motor overload. When the actual current is greater than this value, the overload increases on a cumulative basis.	105.0% (0.0%~130.0%)
F10.59 (0x0A3B) STOP	Motor Overload Current Coefficient	V/F SVC FVC PMVF PMSVC PMFVC Calculated motor overload current = actual current * motor overload current coefficient.	100.0% (0.0%~250.0%)

Long-term overload operation of the motor will lead to extreme overheat, the heat parameter and the heat loss parameter determines the motor temperature rise, if the motor overload protection and motor current show inverse time characteristic curve, this is related to motor operation frequency. When setting F10.59 = 100.0%, the overload protection curve is shown as follows.

The comparison of the overload curve of each level at 50 Hz

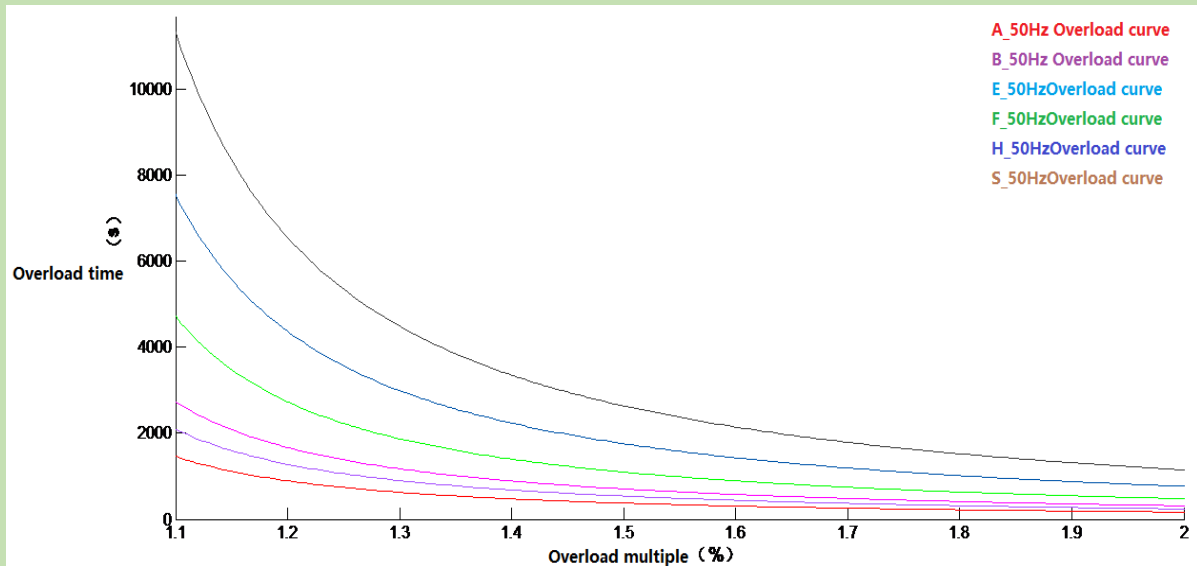

The overload time table of key points of each level at 50 Hz

Motor overload protection		(Calculated motor overload current/rated current) × 100%		
		110%	150%	200%
Time (min)		75	16	3.5
Insulation Class	F			

The overload protection curve under different frequency when the default is F level.

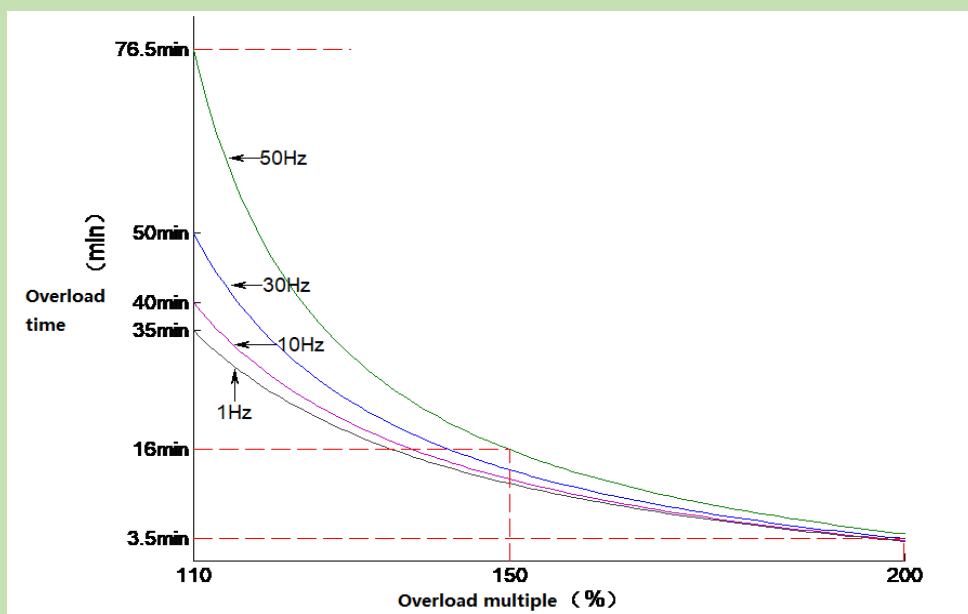

Note: Users need to set the industrial control according to the actual condition of the motor, and set the values of F10.55~F10.59 correctly, to effectively protect the motor.

When a inverter operates with multiple motors in parallel, the thermal relay protection function will not work, to protect

motors effectively, please install a thermal relay at incoming line end of each motor.

6.13 Group F11: Keypad Parameters

Group F11.0x: Button Operation

◇ F11.00: Button Lock Selection

Parameter Code (Address)	Name	Description	Default (Range)
F11.00 (0x0B00) RUN	Parameters and button lock selection	V/F SVC FVC PMVF PMSVC PMFVC	0 (0~3)

0: Not locked

Parameters and button lock function is not active.

1: Function parameter is locked

It is disabled to modify the set points of all the functional parameters (except for the specific function codes of up and down buttons, which can be modified by the up and down buttons). You cannot enter the parameter modification interface through the keypad, but can select the monitoring value by the shift keypad. All button functions on the keypad are not locked.

2: Function parameter and button lock

Lock the set points of all the function parameters. You can neither enter the parameter modification interface through the keypad, nor select the keypad monitoring value. Do not modify the parameter. Lock all buttons on the keypad except RUN/STOP/JOG/PRG.

3: Function parameter and button lock

Lock the set points of all the function parameters, and disable modifying parameters. At the same time, lock all the buttons on the keypad except PRG.

Note:

- How to unlock dual-line digital tube keypad: After pressing the PRG menu button, the first line of the keypad will display CodE. Then you can directly enter the user's password (F11.01-User Password) in the second line by pressing the SET button to unlock it.
- How to unlock single-line digital tube keypad: The single-line digital tube Keypad will display CodE after pressing the PRG menu button, then press the "SET" button, the digital tube will display flashing input cursor, enter the user password (F11.01-User Password) through the up and down buttons, and then press the SET button again to confirm, then you can unlock.
- The user password is a protective parameter set to protect the inverter parameters from tampering. After setting the password, keep it in mind to avoid the inconvenience when you want to change the parameters later.
- After unlocking, entering the monitoring interface will exit the unlock. If you want to return to the parameter interface, you need to enter the password again.

✧ **F11.00: Button Lock Password**

Parameter Code (Address)	Name	Description	Default (Range)
F11.01 (0x0B01) RUN	Button lock password	V/F SVC FVC PMVF PMSVC PMFVC Set the button lock password.	0 (0~65535)

✧ **F11.02: Keypad Multi-Functional Button Selection**

Parameter Code (Address)	Name	Description	Default (Range)
F11.02 (0x0B02) STOP	Keypad multi-function button selection	V/F SVC FVC PMVF PMSVC PMFVC	0 (0~7)

0: Invalid

1: Reverse running button

2: Forward jogging button

3: Reverse jogging button

4: Switching between the keypad command channel and the terminal command channel

5: Switching between the keypad command channel and the communication command channel

6: Switching between the terminal command channel and the communication command channel

7: Switching between keypad, terminal and communication command channels

✧ **F11.03: Keypad STOP Button Setting**

Parameter Code (Address)	Name	Description	Default (Range)
F11.03 (0x0B03) STOP	Keypad stop button setting	V/F SVC FVC PMVF PMSVC PMFVC	0 (0~2)

0: Non-Keypad control mode is disabled When the signal of the non-keypad control mode is valid, the STOP button cannot be used as a stop button to stop the inverter.

1: Non-Keypad control mode stop the inverter by the stop mode. When the signal of the non-keypad control mode is valid, the keypad STOP button can be used as a stop button to stop the inverter by the stop mode set by [F07.10].

It can be used as a stop button, and the stop mode is the mode set by [F07.10].

2: Non-Keypad control mode stop the inverter by free stop. When the signal of the non-keypad control mode is valid, the keypad STOP button cannot be used as a stop button to stop the inverter freely.

It can be used as a stop button, and the stop mode is free stop.

Note:

- If [F11.03] is selected as 1 or 2, press the keypad stop button to stop the motor under the terminal control or RS485 communication control, the inverter will be locked in the stop state. If you want to restart the inverter, you should sent the stop command from the selected run command channel, and the inverter cannot run until the locked state is released.

❖ **F11.04: Function of Up/Down Button (Knob) in Status Interface**

Parameter Code (Address)	Name	Description	Default (Range)
F11.04 (0x0B04) STOP	Function of up/down button (knob) in status interface	V/F SVC FVC PMVF PMSVC PMFVC	0011 (0000~0213)

LED"0": Keypad up/down button used for modification

0: Invalid

1: Adjust F01.09 frequency set by keypad. Modify the set point of parameter [F01.09] promptly by keypad up/down button.

2: Adjust F13.01 set by PID keypad. Modify the set point of parameter [F13.01] promptly by keypad up and down button.

3: Modify parameter number settings by keypad up and down buttons. Modify the set point of [Fxx.yy] corresponding to the parameter F11.05 promptly by keypad up and down button.

LED"00": Storage after power-off

0: Frequency is not stored after power-off

1: Frequency is stored after power-off

Selects whether the inverter saves the modified value to the corresponding parameter during power failure after the parameter is promptly modified by the keypad up and down button.

LED"000": Action limit

0: Adjustable during operation and stopping

1: Adjustable only during operation, and maintained during stopping

2: Adjustable during running; reset during stop

LED"0000": Reserved

Note:

- LED"00": Select whether the changed data is stored in an EEPROM.

✧ F11.05: Parameter Code Setting Quick Change with Up/Down Button

Parameter Code (Address)	Name	Description	Default (Range)
F11.05 (0x0B05) RUN	Parameter code setting quick change with up/down button	V/F SVC FVC PMVF PMSVC PMFVC	0109 (0000~2999)

Modifying parameter number settings by keypad up and down button

LED"0" and LED"00": Set yy in function parameter number Fxx.yy to 00-99.

LED"000" and LED"0000": Set xx in function parameter number Fxx.yy to 00-29.

Note:

- F11.04 is active when the LED"0" is 3. For example, when F11.05 = 0342, the up and down buttons of the keypad can be used to modify the point value of [F03.42] promptly.

✧ F11.06: Keypad Command Button Selection

Parameter Code (Address)	Name	Description	Default (Range)
F11.06 (0x0B06) STOP	Keypad command button selection	V/F SVC FVC PMVF PMSVC PMFVC	0000 (0000~2122)

LED"0": Internal and external keypad button commands

(Run commands, and stop/reset commands)

0: External commands takes precedence. When external commands are valid, internal ones are invalid

1: Internal commands takes precedence. When internal commands are valid, external ones are invalid

2: Both internal and external commands are valid, and the stop/reset command takes precedence

LED"00": Reserved

LED"000": Reserved

LED"0000": Keypad test (successful communication rate)

Group F11.1x: Status Interface Loop Monitoring

◇ F11.10: Function of Left/Right Buttons in Status Interface

Parameter Code (Address)	Name	Description	Default (Range)
F11.10 (0x0B0A) STOP	Function of left/right buttons in status interface	V/F SVC FVC PMVF PMSVC PMFVC	0011 (0000~0011)

LED"0": The left button is used to adjust the first line of monitoring 0: Invalid, 1: Valid

LED"00": The right button is used to adjust the second line of monitoring 0: Invalid, 1: Valid

Note:

- When it is invalid, the current loop parameter will be displayed, and the loop parameter 1 will be displayed after power-on again.
- When the left/right button is invalid, when pressing the left/right button, the monitoring will not switch. When the left/right button function selection is changed to active, the monitoring quantity changes immediately.

◇ F11.11: Loop Parameter 1 for the Keypad First Line

Parameter Code (Address)	Name	Description	Default (Range)
F11.11 (0x0B0B) RUN	Loop parameter 1 for the keypad first line	V/F SVC FVC PMVF PMSVC PMFVC Set the parameter display contents of single-line keypad and dual-line keypad.	0000 (0000~0763)

◇ F11.12: Loop Parameter 2 for the Keypad First Line

Parameter Code (Address)	Name	Description	Default (Range)
F11.12 (0x0B0C) RUN	Loop parameter 2 for the keypad first line	V/F SVC FVC PMVF PMSVC PMFVC Set the parameter display contents of single-line keypad and dual-line keypad.	0001 (0000~0x0763)

◇ F11.13 Loop Parameter 3 for the Keypad First Line

Parameter Code (Address)	Name	Description	Default (Range)
F11.13 (0x0B0D) RUN	Loop parameter 3 for the keypad first line	V/F SVC FVC PMVF PMSVC PMFVC Set the parameter display contents of single-line keypad and dual-line keypad.	0002 (0000~0763)

◇ **F11.14: Loop Parameter 4 for the Keypad First Line**

Parameter Code (Address)	Name	Description	Default (Range)
F11.14 (0x0B0E) RUN	Loop parameter 4 for the keypad first line	V/F SVC FVC PMVF PMSVC PMFVC Set the parameter display contents of single-line keypad and dual-line keypad.	0011 (0000~0763)

◇ **F11.15: Loop Parameter 1 for the Keypad Second Line**

Parameter Code (Address)	Name	Description	Default (Range)
F11.15 (0x0B0F) RUN	Loop parameter 1 for the keypad second line	V/F SVC FVC PMVF PMSVC PMFVC Set the parameter display contents of the dual-line keypad.	0002 (0000~0763)

◇ **F11.16: Loop Parameter 2 for the Keypad Second Line**

Parameter Code (Address)	Name	Description	Default (Range)
F11.16 (0x0B10) RUN	Loop parameter 2 for the keypad second line	V/F SVC FVC PMVF PMSVC PMFVC Set the parameter display contents of the dual-line keypad.	0004 (0000~0763)

◇ **F11.17: Loop Parameter 3 for the Keypad Second Line**

Parameter Code (Address)	Name	Description	Default (Range)
F11.17 (0x0B11) RUN	Loop parameter 3 for the keypad second line	V/F SVC FVC PMVF PMSVC PMFVC Set the parameter display contents of the dual-line keypad.	0010 (0000~0763)

◇ **F11.18: Loop Parameter 4 for the Keypad Second Line**

Parameter Code (Address)	Name	Description	Default (Range)
--------------------------	------	-------------	-----------------

F11.18 (0x0B12) RUN	Loop parameter 4 for the keypad second line	V/F SVC FVC PMVF PMSVC PMFVC Sets the parameter display contents of the dual-line keypad.	0012 (0000~0763)
---------------------------	---	---	---------------------

Keypad display parameters: Set the parameter display contents of the single-line keypad and dual-line keypad.

LED"0" and LED"00": Set yy in monitoring parameter number Cxx.yy to 00~63

LED"000" and LED"0000": Set xx in monitoring parameter number Cxx.yy to 00~07

Note:

- The parameters [F11.15~F11.18] only apply to dual-line keypads. The dual-line keypad switches the display parameters 1-4 on the second line of the keypad in order by the "▶" button.
- The single-line keypad switches the display parameters 1-4 on the second line of the keypad in order by long pressing the SET button (press "◀" key in the dual-line keypad). There is no memory function after switching the display content, and the content of display parameter 1 will be displayed by default after power-on.

Group F11.2x: Monitoring Parameter Control

◇ F11.20: Keypad Display Item Setting

Parameter Code (Address)	Name	Description	Default (Range)
F11.20 (0x0B14) RUN	Keypad display item setting	V/F SVC FVC PMVF PMSVC PMFVC	0002 (0000~111F)

LED"0": Output Frequency Display Selection

- 0: Target Frequency Display the target frequency currently controlling the motor
- 1: Operation frequency Display the output frequency of the inverter after calculation.
- 2~F: Operating frequency filtering. The larger the value, the deeper the filtering

LED"00": Reserved

- 0: Invalid
- 1: The active power to remove loss on the stator resistance

LED"000": Power display dimension

- 0: Power display percentage (%) Display the output power of 100%, 100.0% is the motor rated power
- 1: Power display in kilowatt (kW) Display the actual value of output frequency

LED"0000": Reserved

◇ F11.21: Speed Display Coefficient

Parameter Code (Address)	Name	Description	Default (Range)
-----------------------------	------	-------------	--------------------

F11.21 (0x0B15) RUN	Speed display coefficient	V/F SVC FVC PMVF PMSVC PMFVC Set the display parameter for mechanical speed of the keypad monitor, 100.0% corresponds to rated speed of motor.	100.0% (0.0%~500.0%)
---------------------------	------------------------------	--	-------------------------

Note:

- Correct C00.05 mechanical speed value

◇ **F11.22: Power Display Coefficient**

Parameter Code (Address)	Name	Description	Default (Range)
F11.22 (0x0B16) RUN	Power display coefficient	V/F SVC FVC PMVF PMSVC PMFVC Set the display parameter rate for output power of keypad monitoring.	100.0% (0.0%~500.0%)

Note:

- Correct C00.10 output power value

◇ **F11.23: Monitoring Parameter Group Display Selection**

Parameter Code (Address)	Name	Description	Default (Range)
F11.23 (0x0B17) RUN	Monitoring parameter group display selection	V/F SVC FVC PMVF PMSVC PMFVC LED"0": Monitoring parameter mapping 0: SI23(NEW) 1: AC70 LED"00": Group C05 display selection 0, 1: Parameters related to VF mode 2: Parameters related to VC mode LED"000": C00.40 - C00.63 display selection 0: Do not display 1: Display LED"0000": Communication fault code switching 0: Communication fault code table 1 (SI23 NEW) 1: Communication fault code table 2 (AC70) 2: Communication fault code table 3 (SI23 OLD)	0000 (0000~FFFF)

When then monitoring parameter mapping is AC70, the monitoring parameter address maps to 0x0Cxx (corresponding to AC70), to read the F12 parameter group at this time, the communication address should be changed to 0x1Cxx.

◇ F11.24: Monitoring Parameter Filtering Selection

Parameter Code (Address)	Name	Description	Default (Range)
F11.24 (0x0B18) RUN	Monitoring parameter filtering selection	V/F SVC FVC PMVF PMSVC PMFVC LED"0": Output current display filtering 0-F: The larger the value, the deeper the filtering LED"00": Reserved LED"000": Reserved LED"0000": Reserved	0002 (0000~000F)

◇ F11.25: Display during Motor Auto-tuning

Parameter Code (Address)	Name	Description	Default (Range)
F11.25 (0x0B19) STOP	Display during motor Auto-tuning	V/F SVC FVC PMVF PMSVC PMFVC 0: Show the status of Auto-tuning process 1: Do not the status of Auto-tuning process	0 (0~1)

◇ F11.27: Fault Self-Recovery Display Selection

Parameter Code (Address)	Name	Description	Default (Range)
F11.27 (0x0B1B) RUN	Fault self-recovery display selection	V/F SVC FVC PMVF PMSVC PMFVC LED"0": Display the fault upon fault self-recovery 0: Do not display 1: Display	0001 (0000~0001)

0: Do not display The keypad will not display the character of the fault in fault self-recovery interval, but the running indicator light is still lighten.

1:Display The keypad will display the character of the fault in fault self-recovery interval, but the running indicator light is still lighten.

Group F11.3x: Special Keypad Functions

◇ F11.31: Lower Voltage Limit of Keypad Potentiometer

Parameter Code (Address)	Name	Description	Default (Range)
--------------------------	------	-------------	-----------------

F11.31 (0x0B1F) RUN	Lower voltage limit of keypad potentiometer	V/F SVC FVC PMVF PMSVC PMFVC	0.50V (0.00V~3.00V)
---------------------------	---	------------------------------	------------------------

◇ **F11.32: Corresponding Value to Lower Limit of Keypad Potentiometer**

Parameter Code (Address)	Name	Description	Default (Range)
F11.32 (0x0B20) RUN	Corresponding value to lower limit of keypad potentiometer	V/F SVC FVC PMVF PMSVC PMFVC	0.00% (0.00%~100.00%)

◇ **F11.33: Upper Voltage Limit of Keypad Potentiometer**

Parameter Code (Address)	Name	Description	Default (Range)
F11.33 (0x0B21) RUN	Upper voltage limit of keypad potentiometer	V/F SVC FVC PMVF PMSVC PMFVC	2.80V (0.00V~3.00V)

◇ **F11.34: Value Corresponding to the Upper Limit of Keypad Potentiometer**

Parameter Code (Address)	Name	Description	Default (Range)
F11.34 (0x0B22) RUN	Corresponding value to upper limit of keypad potentiometer	V/F SVC FVC PMVF PMSVC PMFVC	100.00% (0.00%~100.00%)

Note: The parameters F11.30~F11.34 are only used to adjust the corresponding relations of optional outer single-line keypad potentiometer.

6.14 Group F12: Communication Parameters

Modbus communication is divided in two groups: This two groups of ports are independent on hardware.

Table 11.11 Modbus Communication Group

Modbus Communication Group	Interface	Master Parameters	Slave Parameters	Remarks
1	Terminals A+ and B-	F12.10-F12.19	F12.01-F12.09	

2	RJ45 (reticle)	F12.10-F12.19	F12.21-F12.29	This interface can be selected for Keypad communication. Models of 45 kW and above only support dual-line keypad communication.
---	----------------	---------------	---------------	---

The parameters F12.00 - F12.29 are used to set the inverter when using the Modbus communication. Modbus protocol can be used for serial communication with the programmable logic controller (PLC).

Group F12.0x: Modbus Slave Parameters

◇ F12.00: Master/Slave Selection

Parameter Code (Address)	Name	Description	Default (Range)
F12.00 (0x0C00) STOP	Master/Slave selection	V/F SVC FVC PMVF PMSVC PMFVC Set the inverter as the Modbus communication master or slave.	0 (0~1)

0: Slave When the inverter is used as a slave, the communication address is set by [F12.01]. At this time, the inverter accepts the command from the master on the communication network. According to the setting of parameter [F12.04], the inverter selects whether to respond to data during write operation.

1: Master When the inverter is used as a master, it will send the data of the master to the communication network through the broadcast command, and all slaves receive the commands from the master.

◇ F12.01: Modbus Communication Address

Parameter Code (Address)	Name	Description	Default (Range)
F12.01 (0x0C01) STOP	Modbus communication address	V/F SVC FVC PMVF PMSVC PMFVC Set the slave station address for communication of the inverter.	1 (1~247)

Note: If this parameter is set as 0, the inverter will not respond to the Modbus communication.

When the host computer (master station) communicates with the inverter through Modbus, the slave station need to be set for the inverter. Please set a value other than F12.01 = 0. The set slave station address should not conflict with other salve station equipment.

◇ F12.02: Communication Baud Rate Selection

Parameter Code (Address)	Name	Description	Default (Range)
F12.02 (0x0C02) STOP	Communication baud rate selection	V/F SVC FVC PMVF PMSVC PMFVC Set the baud rate of Modbus communication.	3 (0~6)

0:1200 bps

1:2400 bps

2:4800 bps

3:9600 bps

4:19200 bps

5:38400 bps

6:57600 bps

✧ **F12.03: Modbus Communication Data Format**

Parameter Code (Address)	Name	Description	Default (Range)
F12.03 (0x0C03) STOP	Modbus communication data format	V/F SVC FVC PMVF PMSVC PMFVC Selects the communication check used for Modbus communication.	0 (0~5)

Note: If the data format settings are different, communication may fail.

0: (N, 8, 1) No check, data bits: 8, stop bits: 1

1: (E, 8, 1) Even parity check, data bits: 8, stop bits: 1

2: (O, 8, 1) Odd parity check, data bits: 8, stop bits: 1

3: (N, 8, 2) No check, data bits: 8, stop bits: 2

4: (E, 8, 2) Even parity check, data bits: 8, stop bits: 2

5: (O, 8, 2) Odd parity check, data bits: 8, stop bits: 2

◇ F12.04: Modbus Communication Transmission Response Processing

Parameter Code (Address)	Name	Description	Default (Range)
F12.04 (0x0C04) RUN	Modbus communication transmission response processing	V/F SVC FVC PMVF PMSVC PMFVC Select the communication check used for Modbus communication.	0 (0~1)

This parameter selects whether the inverter will respond to the write command from the host computer. If the host computer needs the inverter to respond to the information, the inverter will occupy the communication bus at different times. The host computer needs to save enough time to respond to the information when performing communication control. If the host computer does not need the inverter to respond the information and only sends the command to the inverter, select the write operation without response to improve the utilization efficiency of communication bus. This parameter is active for write operations only and has no effect on read operations.

0: Write with response

1: Write without response

◇ F12.05: Modbus Communication Response Delay

Parameter Code (Address)	Name	Description	Default (Range)
F12.05 (0x0C05) RUN	Modbus communication response delay	V/F SVC FVC PMVF PMSVC PMFVC Set the response delay of Modbus master-slave communication.	0ms (0ms~5000ms)

This parameter defines the interval between sending the response data to the host computer after receiving the data when the inverter serve as the slave station of Modbus communication. If response delay is less than system processing time, the response delay is subject to the system processing time. If response delay is more than system processing time, the system need to wait the delay after processing the data, and will not send the data to host computer until the response delay time is up.

This parameter defines the inverter as the master station of Modbus communication, the delay is the transmission interval of the master, and the minimum internal limit is 2.5 characters.

◇ F12.06: Modbus Communication Timeout Fault Time

Parameter Code (Address)	Name	Description	Default (Range)
F12.06 (0x0C06) RUN	Modbus communication timeout fault time	V/F SVC FVC PMVF PMSVC PMFVC Set the Modbus communication timeout fault time.	1.0s (0.1s~100.0s)

Modbus communication timeout fault time: If the interval between one communication and the next communication exceeds the communication timeout time, that will be considered that the communication has disconnection fault, and determine the action against disconnection fault by [F12.07].

◇ **F12.07: Communication disconnection Processing**

Parameter Code (Address)	Name	Description	Default (Range)
F12.07 (0x0C07)RU N	Communication disconnection processing	V/F SVC FVC PMVF PMSVC PMFVC Select the stop mode of the motor when E. CE [Modbus communication fault] is detected.	0 (0~3)

Communication disconnection processing mode selection

0: Do not detect timeout fault

1: Alarm and free stop

2: Warning and keep running

3: Forced stop

Note:

- Forced stop command is set. The motor is forced to stop by decelerate mode, and it will no longer respond to running command before stop.

◇ **F12.08: Receiving Data (Address 0x3000) Zero Bias**

Parameter Code (Address)	Name	Description	Default (Range)
F12.08 (0x0C08) RUN	Receiving data (address 0x3000) zero bias	V/F SVC FVC PMVF PMSVC PMFVC Set the zero offset of 0x3000 communication address. When the final offset result is negative, it will be treated as zero.	0.00 (-100.00~100.00)

◇ **F12.09: Receive Data (Address 0x3000) Gain**

Parameter Code (Address)	Name	Description	Default (Range)
F12.09 (0x0C09) RUN	Receive data (address 0x3000) gain	V/F SVC FVC PMVF PMSVC PMFVC Set the 0x3000 communication address gain.	100.0% (0.0%~500.0%)

Group F12.1x: Modbus Master Parameters

◇ **F12.10: Master Loop Transmission Parameter Selection**

Parameter Code (Address)	Name	Description	Default (Range)
F12.10 (0x0C0A) RUN	Master loop transmission parameter selection	V/F SVC FVC PMVF PMSVC PMFVC Set the master loop transmission parameter.	0031 (0000~CCCC)

LED"0", LED"00",LED"000",LED"0000"

0: Invalid

1: Master run command

2: Master given frequency

3: Master output frequency

4: Master upper limit frequency

5: Master given torque

6: Master output torque

7: Reserved

8: Reserved

9: Master PID setting

A: Master PID feedback

B: Reserved

C: Active current component

✧ **F12.11: Custom Address Of Given Frequency**

Parameter Code (Address)	Name	Description	Default (Range)
F12.11 (0x0C0B) RUN	Custom address of given frequency	V/F SVC FVC PMVF PMSVC PMFVC Set the given frequency custom address.	0000 (0000~FFFF)

Note:

➤ 0 by default: Invalid. Other values indicate that this address priority is higher than the function code parameter address.

✧ **F12.12: Command Setting Custom Address Setting**

Parameter Code (Address)	Name	Description	Default (Range)
F12.12 (0x0C0C) RUN	Command setting custom address setting	V/F SVC FVC PMVF PMSVC PMFVC Set the command setting custom address.	0000 (0000~FFFF)

Note:

- 0 by default: Invalid. Other values indicate that this address priority is higher than the function code parameter address.

◇ **F12.13: Custom Address Of Forward Running Command**

Parameter Code (Address)	Name	Description	Default (Range)
F12.13 (0x0C0D) RUN	Custom address of forward running command	V/F SVC FVC PMVF PMSVC PMFVC Set the address of forward running command	0001 (0000~FFFF)

◇ **F12.14: Custom Address of Reverse Running Command**

Parameter Code (Address)	Name	Description	Default (Range)
F12.14 (0x0C0E) RUN	Custom address of reverse running command	V/F SVC FVC PMVF PMSVC PMFVC Set the address of reverse running command	0002 (0000~FFFF)

◇ **F12.15: Custom Address of Stop Command**

Parameter Code (Address)	Name	Description	Default (Range)
F12.15 (0x0C0F) RUN	Custom address of stop command	V/F SVC FVC PMVF PMSVC PMFVC Set the address of stop command.	0005 (0000~FFFF)

◇ **F12.16: Custom Address of Reset Command**

Parameter Code (Address)	Name	Description	Default (Range)
F12.16 (0x0C10) RUN	Custom address of reset command	V/F SVC FVC PMVF PMSVC PMFVC Set the address of reset command.	0007 (0000~FFFF)

◇ **F12.19: Selection of Commands Sent by Master**

Parameter Code (Address)	Name	Description	Default (Range)
F12.19 (0x0C13) RUN	Master sending command selection	V/F SVC FVC PMVF PMSVC PMFVC Master sending command selection. 0: Send run command; 1: Send running status	0 (0~1)

Group F12.2x: Special Modbus Functions◇ **F12.20: RJ45 Interface Communication Mode Selection**

Parameter Code (Address)	Name	Description	Default (Range)
F12.20 (0x0C14) STOP	RJ45 interface communication mode selection	V/F SVC FVC PMVF PMSVC PMFVC	0 (0~3)

0: Dual-line keypad communication

1: Modbus RS485 communication (only for slave)

1: Modbus slave (Related parameters are set by F12.2x)

2: Modbus master (transmission parameters are set by F12.1x)

3: Water tank host

Note:

- When RJ45 interface is Modbus RS485 communication, the communication command setting and frequency setting channel will correspond to the option card.
- Models of T3 45 kW and above only support dual-line keypad communication

◇ **F12.21: Slave Address of RJ45 Interface**

Parameter Code (Address)	Name	Description	Default (Range)
F12.21 (0x0C15) STOP	Slave address of RJ45 interface	V/F SVC FVC PMVF PMSVC PMFVC Set the slave address when RJ45 interface is Modbus communication.	1 (1~247)

◇ **F12.22: RJ45 Interface Communication Baud Rate**

Parameter Code (Address)	Name	Description	Default (Range)
F12.22 (0x0C16) STOP	RJ45 interface communication baud rate selection	V/F SVC FVC PMVF PMSVC PMFVC Set the baud rate when RJ45 interface is Modbus communication.	3 (0~5)

0: 1200 bps

1: 2400 bps

2: 4800 bps

3: 9600 bps

4: 19200 bps

5: 38400 bps

Note: On the scene where the communication line interference is large, it will affect the successful communication rate, so the baud rate can be gradually reduced to improve the success rate.

◇ **F12.23: RJ45 Interface Data Format**

Parameter Code (Address)	Name	Description	Default (Range)
F12.23 (0x0C17) STOP	RJ45 interface data format	V/F SVC FVC PMVF PMSVC PMFVC Set the data format when RJ45 interface is Modbus communication.	0 (0~5)

This parameter set the data format for RJ45 interface communication. If the data formats are different, the communication may fail.

0: (N, 8, 1) No check, data bits: 8, stop bits: 1

1: (E, 8, 1) Even parity check, data bits: 8, stop bits: 1

2: (O, 8, 1) Odd parity check, data bits: 8, stop bits: 1

3: (N, 8, 2) No check, data bits: 8, stop bits: 2

4: (E, 8, 2) Even parity check, data bits: 8, stop bits: 2

5: (O, 8, 2) Odd parity check, data bits: 8, stop bits: 2

◇ F12.24: RJ45 Interface Transmission Response Processing

Parameter Code (Address)	Name	Description	Default (Range)
F12.24 (0x0C18) RUN	RJ45 interface transmission response processing	V/F SVC FVC PMVF PMSVC PMFVC Set the transmission response processing when RJ45 interface is Modbus communication.	0 (0~1)

This parameter selects whether the inverter will respond to the write command from the host computer. If the host computer needs the inverter to respond to the information, the inverter will occupy the communication bus at different times. The host computer needs to save enough time to respond to the information when performing communication control. If the host computer does not need the inverter to respond the information and only sends the command to the inverter, select the write operation without response to improve the utilization efficiency of communication bus. This parameter is active for write operations only and has no effect on read operations.

0: Write with response

1: Write without response

◇ F12.25: RJ45 Interface Communication Response Delay

Parameter Code (Address)	Name	Description	Default (Range)
F12.25 (0x0C19) RUN	RJ45 interface communication response delay	V/F SVC FVC PMVF PMSVC PMFVC The response delay when RJ45 interface is Modbus communication.	0ms (0ms~500ms)

This parameter defines the interval between sending the response data to the host computer after receiving the data when the inverter serve as the slave station of Modbus communication. If response delay is less than system processing time, the response delay is subject to the system processing time. If response delay is more than system processing time, the system need to wait the delay after processing the data, and will not send the data to host computer until the response delay time is up.

◇ F12.26: RJ45 Interface Communication Timeout Fault Time

Parameter Code (Address)	Name	Description	Default (Range)
F12.26 (0x0C1A) RUN	RJ45 interface communication timeout fault time	V/F SVC FVC PMVF PMSVC PMFVC The communication timeout when RJ45 interface is Modbus communication.	1.0s (0.1s~100.0s)

If the interval between one communication and the next communication exceeds the communication timeout time, it will be considered that the communication has disconnection fault, and determine the action against disconnection fault by [F12.27].

◇ F12.27: RJ45 Interface Communication disconnection Processing

Parameter Code (Address)	Name	Description	Default (Range)
F12.27 (0x0C1B) RUN	RJ45 Interface Communication disconnection Processing	V/F SVC FVC PMVF PMSVC PMFVC Sets the disconnection processing mode when RJ45 interface is for Modbus communication.	0 (0~3)

Communication disconnection processing mode selection

0: Do not detect timeout fault

1: Alarm and free stop

2: Warning and keep running

3: Forced stop

Note:

- Forced stop command is set. The motor is forced to stop by decelerate mode, and it will no longer respond to running command before stop.

Group F12.3x: PROFIBUS-DP Communication

◇ F12.30: DP Card Address

Parameter Code (Address)	Name	Description	Default (Range)
F12.30 (0x0C1E) RUN	DP card address	V/F SVC FVC PMVF PMSVC PMFVC Set the address for DP communication to set the slave.	1 (1~247)

Note: Do not hot plug the DP card.

Parameter Code (Address)	Name	Description	Default (Range)
F12.31 (0x0C1F) RUN	DP baud rate	V/F SVC FVC PMVF PMSVC PMFVC Set baud rate according to DP communication.	0

Default value no debugging required

◇ F12.32: DP Communication disconnection Processing

Parameter Code (Address)	Name	Description	Default (Range)
F12.32 (0x0C20) STOP	DP master-slave communication fault action	V/F SVC FVC PMVF PMSVC PMFVC Select the action for DP master-slave communication fault.	0 (0~2)

0: Do not detect timeout fault

1: Alarm and free stop

2: Warning and keep running

Group F12.4x: CAN Communication

◇ F12.40: CAN Mode Selection

Parameter Code (Address)	Name	Description	Default (Range)
F12.40 (0x0C28) RUN	CAN mode selection	V/F SVC FVC PMVF PMSVC PMFVC	0 (0~1)

Select the CAN communication mode when the inverter performs CAN communication.

0: Slave station

1: Master station defined by VEICHI

Note: Do not hot plug the CAN card.

◇ F12.41: CAN Communication Slave Address

Parameter Code (Address)	Name	Description	Default (Range)
F12.41 (0x0C29)	CAN communication slave address	V/F SVC FVC PMVF PMSVC PMFVC	1 (1~247)

Note:

➤ When set the address, do not duplicate with other nodes, and set a value other than 0.

◇ F12.42: CAN Communication Baud Rate Selection

Parameter Code (Address)	Name	Description	Default (Range)
F12.42 (0x0C2A) RUN	CAN communication baud rate	V/F SVC FVC PMVF PMSVC PMFVC	3 (0~6)

CAN communication baud rate Sets the baud rate of CAN communication.

0: 20 kbps

1: 50 kbps

2: 100kbps

3: 125kbps

4: 250kbps

5: 500kbps

6: 1Mbps

◇ **F12.43: CAN Communication disconnection Processing**

Parameter Code (Address)	Name	Description	Default (Range)
F12.43 (0x0C2B) RUN	CAN Master-Slave Communication Fault Action	V/F SVC FVC PMVF PMSVC PMFVC CAN Master-Slave Communication Fault Action	0 (0~2)

0: Do not detect timeout fault

1: Alarm and free stop

2: Warning and keep running

Group F12.5x: Communication of Extension Ports EX-A and EX-B

◇ F12.50: Extension Port Communication disconnection Processing

Parameter Code (Address)	Name	Description	Default (Range)
F12.50 (0x0C32) RUN	Extension port communication disconnection processing	V/F SVC FVC PMVF PMSVC PMFVC	0000 (0000~0022)

LED"0": EX-A port disconnection action mode

0: Do not detect

1: Alarm and free stop

2: Warning and keep running

LED"00": EX-B port disconnection action mode

0: Do not detect

1: Alarm and free stop

2: Warning and keep running

Note: Do not hot plug the extension card connected to the extension ports.

◇ F12.51: Extension Port EX-A Parameter Updating

Parameter Code (Address)	Name	Description	Default (Range)
F12.51 (0x0C33) STOP	Extension port EX-A parameter updating	V/F SVC FVC PMVF PMSVC PMFVC	0 (0~2)

0: Do not update.

1: Update initial values on power-on.

2: The initial values are restored for extension port EX-A parameters

◇ F12.52: Extension Port EX-B Parameter Updating

Parameter Code (Address)	Name	Description	Default (Range)
-----------------------------	------	-------------	--------------------

F12.52 (0x0C34) STOP	Extension port EX-B parameter updating	V/F SVC FVC PMVF PMSVC PMFVC	0 (0~2)
----------------------------	--	-------------------------------------	------------

0: Do not update.

1: Update initial values on power-on.

2: The initial values are restored for extension port EX-B parameters

◇ **F12.53: Extension Port EX-A Monitor Frame Address Group 1**

Parameter Code (Address)	Name	Description	Default (Range)
F12.53 (0x0C35) RUN	Extension port EX-A monitor frame address group 1	V/F SVC FVC PMVF PMSVC PMFVC	0001 (0000~0763)

◇ **F12.54: Extension Port EX-A Monitor Frame Address Group 2**

Parameter Code (Address)	Name	Description	Default (Range)
F12.54 (0x0C36) RUN	Extension port EX-A monitor frame address group 2	V/F SVC FVC PMVF PMSVC PMFVC	0002 (0000~0763)

◇ **F12.55: Extension Port EX-A Monitor Frame Address Group 3**

Parameter Code (Address)	Name	Description	Default (Range)
F12.55 (0x0C37) RUN	Extension port EX-A monitor frame address group 3	V/F SVC FVC PMVF PMSVC PMFVC	0007 (0000~0763)

◇ **F12.56: Extension Port EX-A Monitor Frame Address Group 4**

Parameter Code (Address)	Name	Description	Default (Range)
F12.56 (0x0C38) RUN	Extension port EX-A monitor frame address group 4	V/F SVC FVC PMVF PMSVC PMFVC	0011 (0000~0763)

LED'0' and LED'00': Lower 8 bits of address 00~63

LED'000' and LED'0000': Higher 8 bits of address 00~07

✧ **F12.57: Extension Port EX-B Monitor Frame Address Group 1**

Parameter Code (Address)	Name	Description	Default (Range)
F12.57 (0x0C39) RUN	Extension port EX-B monitor frame address group 1	V/F SVC FVC PMVF PMSVC PMFVC	0001 (0000~0763)

✧ **F12.58: Extension Port EX-B Monitor Frame Address Group 2**

Parameter Code (Address)	Name	Description	Default (Range)
F12.58 (0x0C3A) RUN	Extension port EX-B monitor frame address group 2	V/F SVC FVC PMVF PMSVC PMFVC	0002 (0000~0763)

✧ **F12.59: Extension Port EX-B Monitor Frame Address Group 3**

Parameter Code (Address)	Name	Description	Default (Range)
F12.59 (0x0C3B) RUN	Extension port EX-B monitor frame address group 3	V/F SVC FVC PMVF PMSVC PMFVC	0007 (0000~0763)

✧ **F12.60: Extension Port EX-B Monitor Frame Address Group 4**

Parameter Code (Address)	Name	Description	Default (Range)
F12.60 (0x0C3C) RUN	Extension port EX-B monitor frame address group 4	V/F SVC FVC PMVF PMSVC PMFVC	0011 (0000~0763)

LED"0" and LED"00": Lower 8 bits of address 00~63

LED"000" and LED"0000": Higher 8 bits of address 00~07

6.15 Group F13: Process PID Control

F13.00~F13.06: PID Setting and Feedback

◇ F13.00: PID Control Given Source

Parameter Code (Address)	Name	Description	Default (Range)
F13.00 (0x0D00) RUN	PID control given source	V/F SVC FVC PMVF PMSVC PMFVC Set the signal source of PID control.	0 (0~9)

This parameter set the input channel for the PID controller to set the signal.

- 0: Keypad digital** The PID set point is determined by the set point of [F13.01].
- 1: Keypad potentiometer setting** (optional external single-line keypad).
- 2: Voltage/current analog AI1 setting** The PID set point is set by voltage/current analog AI1 setting.
- 3: Voltage/current analog AI2 setting** The PID set point is set by voltage/current analog AI2 setting.
- 4: Reserved**
- 5: Terminal pulse PUL setting** The PID set point is set by terminal pulse PUL setting.
- 6: RS485 communication setting** The PID set point is set by RS485 communication setting.
- 7: Optional card** The PID set point is set by the option card. See the optional card instruction for details.
- 8: Terminal selection** The PID set point is selected by the combination of multi-functional input terminals, which are set by [F05.00~F05.09].
- 9: Active current set via communication**

Terminal switching selection diagram:

Terminal 3	Terminal 2	Terminal 1	Selection of Terminal for PID Setting
OFF	OFF	OFF	keypad digital
OFF	OFF	ON	Keypad potentiometer (optional outer single-line Keypad)
OFF	ON	OFF	Voltage/current AI1
OFF	ON	ON	Voltage/current AI2
ON	OFF	OFF	Reserved
ON	OFF	ON	Terminal pulse PUL
ON	ON	OFF	RS485 communication
ON	ON	ON	Option card

If you have any doubts about the above table, please refer to the F14 parameter group for the multi-speed sequence diagram of the multi-speed.

Note:

- Active current component can be sent by VEICHI CAN host. The RS485 communication address is 0x3011.

◇ **F13.01: Keypad Digital of PID Given/Feedback**

Parameter Code (Address)	Name	Description	Default (Range)
F13.01 (0x0D01) RUN	Keypad digital of PID given/feedback	V/F SVC FVC PMVF PMSVC PMFVC Set the PID given/feedback values set by keypad digital.	50.0% (0.0%~100.0%)

This parameter is active only if [F13.00]/[F13.03] is set to the PID given/feedback of keypad digital. After this parameter is changed, the PID set point for the monitoring object will be automatically modified synchronously.

When the LED"0" of parameter [F11.04] is set to 2, the value of the parameter can be promptly modified by the up and down keys of the keypad. After modifying it, whether the inverter saves the modified value during power off is determined by the set point in the LED"00" of the [F11.04] .

◇ **F13.02: PID Setting Change Time**

Parameter Code (Address)	Name	Description	Default (Range)
F13.02 (0x0D02) RUN	PID setting change time	V/F SVC FVC PMVF PMSVC PMFVC Set PID setting change time.	1.00s (0.00s~60.00s)

PID setting change time:

This refers to the time required for the PID setting percentage to change from 0.0% to 100.0%. When the set PID changes, the PID set point changes linearly in accordance with the set change time to reduce the adverse impact of the set mutation on the system.

◇ **F13.03: PID Control Feedback Source**

Parameter Code (Address)	Name	Description	Default (Range)
F13.03 (0x0D03) RUN	PID control feedback source	V/F SVC FVC PMVF PMSVC PMFVC Set the feedback signal source of PID control.	2 (0~9)

Sets the input channel for the tension PID controller feedback signal.

0: Keypad digital PID feedback

The PID feedback channel is determined by the set point of [F13.01].

1: Keypad potentiometer(optional external single-line Keypad).

2: Voltage/current AI1 feedback The PID feedback channel is analog AI1.

3: Voltage/current AI2 feedback The PID feedback channel is analog AI2.

4: Reserved

5: terminal pulse PUL feedback The PID feedback channel is terminal pulse PUL.

6: RS485 communication feedback The PID feedback channel is RS485 communication.

7: Option card The PID feedback channel is option card, refer to the instructions of the option card.

8: Terminal selection The PID feedback channel is selected by the combination of multi-functional input terminals, which are set by [F05.00~F05.09].

9: Local active current

Terminal switching selection diagram:

Terminal 3	Terminal 2	Terminal 1	Selection of Terminal for PID Setting
OFF	OFF	OFF	PID feedback with keypad digital
OFF	OFF	ON	Keypad potentiometer (optional outer single-line Keypad).
OFF	ON	OFF	Current/voltage analog AI1
OFF	ON	ON	Current/voltage analog AI2
ON	OFF	OFF	Reserved.
ON	OFF	ON	Terminal pulse PUL feedback
ON	ON	OFF	Feedback via RS485 communication
ON	ON	ON	Option card.

If you have any doubts about the above table, please refer to the F14 parameter group for the multi-speed sequence diagram of the multi-speed.

Note:

- **The set signal source of PID controller and the feedback signal source of PID controller cannot be set to the same channel, otherwise, PID cannot work normally.**

◇ **F13.04: Feedback Signal Low-Pass Filter Time**

Parameter Code (Address)	Name	Description	Default (Range)
F13.04 (0x0D04) RUN	Feedback signal low-pass filter time	V/F SVC FVC PMVF PMSVC PMFVC Set the feedback signal low-pass filter time.	0.010s (0.000s~6.000s)

Feedback signal filter time: It is used to filter the feedback signal, which can reduce the interference influence on the feedback quantity. The longer the filter time, the stronger the anti-interference capability, but the slower the reaction speed.

◇ **F13.05: Feedback Signal Gain**

Parameter Code (Address)	Name	Description	Default (Range)
F13.05 (0x0D05) RUN	Feedback signal gain	V/F SVC FVC PMVF PMSVC PMFVC Set the feedback signal gain.	1.00 (0.00~10.00)

Feedback Signal Gain: For linear proportional adjustment of feedback input signal

◇ **F13.06: Feedback Signal Range**

Parameter Code (Address)	Name	Description	Default (Range)
F13.06 (0x0D06) RUN	Feedback signal range	V/F SVC FVC PMVF PMSVC PMFVC Set the feedback signal range.	100.0 (0.0~100.0)

Feedback signal range: PID feedback signal range is a dimensionless unit, used to adjust PID feedback display.

F13.07 - F13.24: PID Adjustment

◇ F13.07: PID Control Selection

Parameter Code (Address)	Name	Description	Default (Range)
F13.07 (0x0D07) RUN	PID control selection	V/F SVC FVC PMVF PMSVC PMFVC	0100 (0000~1111)

LED"0": Feedback characteristic selection

0: Positive characteristic. Which applies to the scenario where the PID feedback quantity is greater than the PID set quantity, the frequency of the frequency inverter output is required to decline to maintain the PID balance, such as constant pressure water supply, air supply, winding tension control, etc.

1: Negative characteristic. Which applies to the scenario where the PID feedback quantity is greater than the PID set quantity, the frequency of the frequency inverter output is required to rise to maintain the PID balance, such as central air conditioning constant temperature control, tension control of unwinding, etc.

LED"00": Reserved

LED"000": Reserved

LED"0000": Differential adjustment attribute

0: Differentiate deviation

1: Differentiate feedback

◇ F13.08: PID Preset Output

Parameter Code (Address)	Name	Description	Default (Range)
F13.08 (0x0D08) RUN	PID preset output	V/F SVC FVC PMVF PMSVC PMFVC Set the PID preset output.	100.0% (0.0%~100.0%)

◇ F13.09: PID Preset Output Running Time

Parameter Code (Address)	Name	Description	Default (Range)
F13.09 (0x0D09) RUN	PID preset output running time	V/F SVC FVC PMVF PMSVC PMFVC Used to set the PID preset output running time.	0.0s (0.0s~6500.0s)

When this function is defined as PID running startup, the output is first conducted according to PID preset output [F13.08], and the output value will run continuously for the time set in PID preset output running time [F13.09] before running

according to the PID closed-loop characteristics.

Note: when PID is used for frequency setting, [F01.02=8] preset output at 100% corresponds to the maximum frequency output.

◇ F13.10: PID Control Deviation Limit

Parameter Code (Address)	Name	Description	Default (Range)
F13.10 (0x0D0A) RUN	PID control deviation limit	V/F SVC FVC PMVF PMSVC PMFVC Used to set the PID control deviation limit.	0.0% (0.0%~100.0%)

The maximum allowable deviation of PID feedback value relative to the PID set value. When the feedback value is within this range, PID regulation stops and the output remains unchanged. Appropriate use of this function is helpful to minimize the conflict between the accuracy and stability of system output.

◇ F13.11: Proportional Gain P1

Parameter Code (Address)	Name	Description	Default (Range)
F13.11 (0x0D0B) RUN	Proportional Gain P1	V/F SVC FVC PMVF PMSVC PMFVC Determines the regulation intensity of the PID regulator. The higher the gain, the greater the regulation intensity. However, excessively high intensity may easily result in oscillation.	0.100 (0.000~4.000)

◇ F13.12: Integral Time I1

Parameter Code (Address)	Name	Description	Default (Range)
F13.12 (0x0D0C) RUN	Integral time I1	V/F SVC FVC PMVF PMSVC PMFVC Determines the integral regulation intensity of the PID regulator. The shorter the integral time, the greater the regulation intensity. The PID integral action will be Invalid when the integral time is set to 0.	1.0s (0.0s~600.0s)

◇ F13.13: Differential Gain D1

Parameter Code (Address)	Name	Description	Default (Range)
F13.13 (0x0D0D) RUN	Differentiation gain D1	V/F SVC FVC PMVF PMSVC PMFVC Determines the intensity of the PID regulator to adjust the deviation or rate of change of the feedback signal. Differential adjustment attribute is selected through the [F13.07] kilobit. The longer the differential time, the greater the regulation intensity.	0.000s (0.000~6.000)

◇ F13.14: Proportional Gain P2

Parameter Code (Address)	Name	Description	Default (Range)
F13.14 (0x0D0E) RUN	Proportional gain P2	V/F SVC FVC PMVF PMSVC PMFVC Determines the regulation intensity of the PID regulator. The higher the gain, the greater the regulation intensity. However, excessively high intensity may easily result in oscillation.	0.100 (0.000~4.000)

◇ F13.15: Integral Time I2

Parameter Code (Address)	Name	Description	Default (Range)
F13.15 (0x0D0F) RUN	Integral time I2	V/F SVC FVC PMVF PMSVC PMFVC Set the integral time. When set as 0, the PID integral action is invalid.	1.0s (0.0s~600.0s)

◇ F13.16: Differential Gain D2

Parameter Code (Address)	Name	Description	Default (Range)
F13.16 (0x0D10) RUN	Differentiation gain D2	V/F SVC FVC PMVF PMSVC PMFVC Determines the intensity of the PID regulator to adjust the deviation or rate of change of the feedback signal. Differential adjustment attribute is selected through the [F13.07] kilobit. The longer the differential time, the greater the regulation intensity.	0.000s (0.000~6.000)

The adjustment parameters of the PID controller. The parameter values should be adjusted according to actual system characteristics. PID parameter group 1 (F13.11~F13.13) and PID parameter group 2 (F13.14~F13.16), which are used for condition selection during changeover between two groups of PID parameters through the [F13.17] function code.

Proportional gain:

Determines the regulation intensity of the PID regulator. The higher the gain, the greater the regulation intensity. However, excessively high intensity may easily result in oscillation.

Integral time:

Determines the integral regulation intensity of the PID regulator. The shorter the integral time, the greater the regulation intensity. The PID regulation will be Invalid when the integral time is 0.

Differential time:

Determines the intensity of the PID regulator to adjust the deviation or rate of change of the feedback signal. Differential adjustment attribute is selected through the [F13.07] kilobit. The longer the differential time, the greater the regulation intensity. The function of differential adjustment is to suppress the change of feedback signal by making adjustments based on the trend of its change.

◇ F13.17: PID Parameter Switching Conditions

Parameter Code (Address)	Name	Description	Default (Range)
F13.17 (0x0D11) RUN	PID parameter switching conditions	V/F SVC FVC PMVF PMSVC PMFVC Used to set the PID parameter changeover condition.	0 (0~2)

In some applications, one group of PID adjustment parameters can not meet requirements of the entire process, and different PID parameter groups must be adopted.

PID parameter changeover conditions:

0: No changeover Select PID parameter group 1 for PID parameters.

1: Changeover by using the Xi terminal 23 must be set (PID parameter changeover) for multi-functional terminal function selection. When the terminal is invalid, select PID parameter group 1; when the terminal is valid, select PID parameter group 2.

2: Changeover according to deviation When the absolute value of deviation between the PID setting and the feedback is less than [F13.18], select parameter group 1 for PID parameters; when the absolute value of deviation between the PID setting and the feedback is more than [F13.19], select parameter group 2 for PID parameters; when the absolute value of deviation between the PID setting and the feedback is between the lower value of changeover deviation [F13.18] and the higher value of changeover deviation [F13.19], the PID parameter will be the linear interpolation value of the two groups of PID parameters.

which is shown as follows:

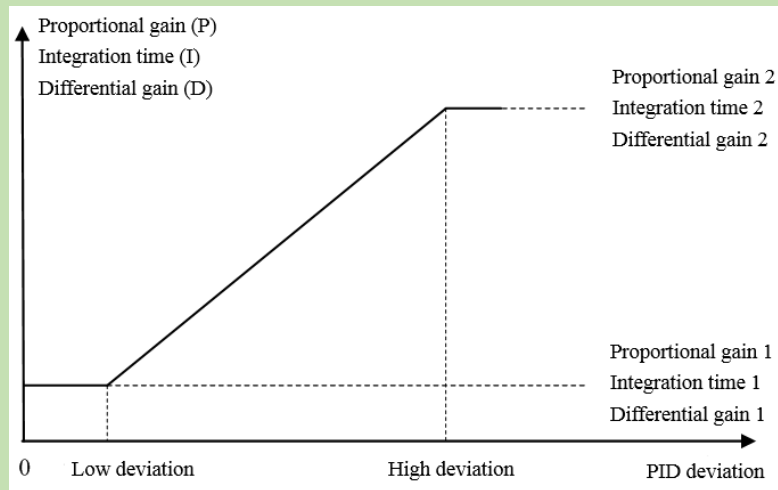

Diagram of deviation-based PID parameter changeover

◇ F13.18: Lower Value of Switching Deviation

Parameter Code (Address)	Name	Description	Default (Range)
F13.18 (0x0D12) RUN	Lower value of switching deviation	V/F SVC FVC PMVF PMSVC PMFVC	20.0% (0.0%~100.0%)

◇ F13.19: Higher Value of Changeover Deviation

Parameter Code (Address)	Name	Description	Default (Range)
F13.19 (0x0D13) RUN	Higher value of switching deviation	V/F SVC FVC PMVF PMSVC PMFVC	80.0% (0.0%~100.0%)

◇ F13.20: Reserved

◇ F13.21: Differentiation Limit

Parameter Code (Address)	Name	Description	Default (Range)
F13.21 (0x0D15) RUN	Differentiation limit	V/F SVC FVC PMVF PMSVC PMFVC	5.0% (0.0%~100.0%)

The differential limit is used to set the range of the PID differential output. In a PID regulator, the function of differentiation is sensitive, as it is likely to cause system oscillation. Generally, the function of PID differentiation is limited to a small range.

◇ F13.22: PID Output Upper Limit

Parameter Code (Address)	Name	Description	Default (Range)
F13.22 (0x0D16) RUN	PID output upper limit	V/F SVC FVC PMVF PMSVC PMFVC Used to set the PID output upper limit value.	100.0% (0.0%~100.0%)

◇ **F13.23: PID Output Lower Limit**

Parameter Code (Address)	Name	Description	Default (Range)
F13.23 (0x0D17) RUN	PID output lower limit	V/F SVC FVC PMVF PMSVC PMFVC Used to set the PID output lower limit value.	0.0% (-100.0~F13.22)

◇ **F13.24: PID output filter time**

Parameter Code (Address)	Name	Description	Default (Range)
F13.24 (0x0D18) RUN	PID output filter time	V/F SVC FVC PMVF PMSVC PMFVC Used to set the PID output filter time.	0.000s (0.000s~6.000s)

The PID output filter time is used to filter the PID output. The filter will weaken the sudden changes of the PID regulation output result and degrade the response performance of the process closed-loop system.

F13.25~F13.28: PID Feedback Disconnection Judgment

The feedback disconnection detection function works in the following way: The sensor is considered to have a broken wire when the detected feedback signal is greater than the set point of [F13.27] or smaller than the set point of [F13.28] and the duration exceeds the delay time in [F13.26] while the frequency inverter is running and PID setting is selected as the frequency inverter setting method.

◇ **F13.25: Feedback disconnection Action Selection**

Parameter Code (Address)	Name	Description	Default (Range)
F13.25 (0x0D19) RUN	Feedback disconnection action selection	V/F SVC FVC PMVF PMSVC PMFVC	0 (0~3)

Feedback disconnection action selection:

0: Continue PID running without alarm This function is invalid and the frequency inverter does not perform disconnection detection.

1: Stop and alarm E. PiD The frequency inverter blocks output immediately when detecting sensor disconnection, and the motor free stop and triggers the alarm E. PiD.

2: Continue PID running and output fault warning A. PiD The frequency inverter continues running based on the PID adjustment when detecting sensor disconnection, but the keypad displays the alarm A. PiD.

3: Run at current frequency and warning A. PiD The frequency inverter maintains the output frequency before the fault when detecting sensor disconnection, but the keypad displays the alarm A. PiD.

◇ **F13.26: Feedback disconnection Detection Time**

Parameter Code (Address)	Name	Description	Default (Range)
F13.26 (0x0D1A) RUN	Feedback disconnection detection time	V/F SVC FVC PMVF PMSVC PMFVC Used to set the PID feedback disconnection detection time.	1.0s (0.0s~120.0s)

◇ **F13.27: Disconnection Alarm Upper Limit**

Parameter Code (Address)	Name	Description	Default (Range)
F13.27 (0x0D1B) RUN	Disconnection alarm upper limit	V/F SVC FVC PMVF PMSVC PMFVC Used to set the PID disconnection alarm upper limit .	100.0% (0.0%~100.0%)

◇ **F13.28: Disconnection Alarm Lower Limit**

Parameter Code (Address)	Name	Description	Default (Range)
F13.28 (0x0D1C) RUN	Disconnection alarm lower limit	V/F SVC FVC PMVF PMSVC PMFVC Used to set the PID disconnection alarm lower limit .	0.0% (0.0%~100.0%)

Disconnection alarm upper limit:

Set the upper limit of PID sensor disconnection detection. The sensor is considered to have a broken wire when the feedback signal has been larger than the upper limit of disconnection alarm for the delay time in [F13.26].

Disconnection alarm lower limit:

Set the lower limit of PID sensor disconnection detection. The sensor is considered to have a broken wire when the feedback signal has been smaller than the upper limit of disconnection alarm for the delay time in [F13.26].

F13.29 - F13.33: Sleep Function

The PID sleep function can be used in water supply industries with constant pressure to achieve the purpose of energy saving.

Sleep determination:

When the sleep function is valid and the PID adjustment output frequency is lower than the sleep frequency set in [F13.30], sleep mode will be entered after the [F13.31] sleep delay (i.e. blocking output when decelerating to zero frequency).

Note: The sleep entry prerequisite: does not trigger before the PID feedback becomes greater than the PID setting at positive characteristics; does not trigger before the PID feedback becomes less than the PID setting at negative characteristics.

Wake-up determination:

When PID feedback characteristics are positive characteristics: compare the value of PID setting minus wake-up deviation [F13.32] with PID feedback. The sleep mode is exited and the normal operating state is entered after the wake-up delay [F13.33] if the former is continuously greater than the latter.

When PID feedback characteristics are negative characteristics: compare the value of PID setting plus wake-up deviation [F13.32] with PID feedback. The sleep mode is exited and the normal operating state is entered after the wake-up delay [F13.33] if the former is continuously less than the latter.

◇ F13.29: Sleep Selection

Parameter Code (Address)	Name	Description	Default (Range)
F13.29 (0x0D1D) RUN	Sleep selection	V/F SVC FVC PMVF PMSVC PMFVC 0: Invalid Do not perform sleep detection 1: Valid Perform sleep detection	0 (0~1)

◇ F13.30: Sleep Frequency

Parameter Code (Address)	Name	Description	Default (Range)
F13.30 (0x0D1E) RUN	Sleep frequency	V/F SVC FVC PMVF PMSVC PMFVC Used to set the PID sleep frequency.	10.0Hz (0.00Hz~F01.10)

◇ F13.31: Sleep Delay Time

Parameter Code (Address)	Name	Description	Default (Range)
F13.31 (0x0D1F) RUN	Sleep delay time	V/F SVC FVC PMVF PMSVC PMFVC Used to set the PID sleep delay time.	60.0s (0.0s~3600.0s)

◇ F13.32: Wake-up Deviation

Parameter Code (Address)	Name	Description	Default (Range)
F13.32 (0x0D20) RUN	Wake-up deviation	V/F SVC FVC PMVF PMSVC PMFVC Used to set the PID wake-up deviation.	5.0% (0.0%~50.0%)

◇ F13.33: Wake-up Delay Time

Parameter Code (Address)	Name	Description	Default (Range)
F13.33 (0x0D21) RUN	Wake-up delay time	V/F SVC FVC PMVF PMSVC PMFVC Used to set the PID wake-up delay time.	1.0s (0.0s~60.0s)

6.16 Group F14: Multi-Speed and Simple PLC

F14.00 - F14.14: Multi-Speed Frequency Setting

This group of parameters is used to set the running frequency of 15 speed stages in PLC program operation and multi-speed control.

Multi-speed control has the priority just lower than jog control. When multi-speed operation is selected, you must set 4 multi-functional input terminals as multi-speed control terminals. See detailed descriptions in [F05.00~F05.09] for specific setting methods.

◇ F14.00: PLC Multi-Speed 1

Parameter Code (Address)	Name	Description	Default (Range)
F14.00 (0x0E00) RUN	PLC Multi-Speed 1	V/F SVC FVC PMVF PMSVC PMFVC Set the frequency of the 1st stage in PLC program operation and multi-speed control.	10.00 Hz (0.00 Hz - maximum frequency)

◇ F14.01: PLC Multi-Speed 2

Parameter Code (Address)	Name	Description	Default (Range)
-----------------------------	------	-------------	--------------------

F14.01 (0x0E01) RUN	PLC Multi-Speed 2	V/F SVC FVC PMVF PMSVC PMFVC Set the frequency of the 2nd stage in PLC program operation and multi-speed control.	20.00 Hz (0.00 Hz - maximum frequency)
---------------------------	----------------------	---	---

◇ **F14.02: PLC Multi-Speed 3**

Parameter Code (Address)	Name	Description	Default (Range)
F14.02 (0x0E02) RUN	PLC Multi-Speed 3	V/F SVC FVC PMVF PMSVC PMFVC Set the frequency of the 3rd stage in PLC program operation and multi-speed control.	30.00 Hz (0.00 Hz - maximum frequency)

◇ F14.03: PLC Multi-Speed 4

Parameter Code (Address)	Name	Description	Default (Range)
F14.03 (0x0E03) RUN	PLC Multi-Speed 4	V/F SVC FVC PMVF PMSVC PMFVC Set the frequency of the 4th stage in PLC program operation and multi-speed control.	40.00 Hz (0.00 Hz - maximum frequency)

◇ F14.04: PLC Multi-Speed 5

Parameter Code (Address)	Name	Description	Default (Range)
F14.04 (0x0E04) RUN	PLC Multi-Speed 5	V/F SVC FVC PMVF PMSVC PMFVC Set the frequency of the 5th stage in PLC program operation and multi-speed control.	50.00 Hz (0.00 Hz - maximum frequency)

◇ F14.05: PLC Multi-Speed 6

Parameter Code (Address)	Name	Description	Default (Range)
F14.05 (0x0E05) RUN	PLC Multi-Speed 6	V/F SVC FVC PMVF PMSVC PMFVC Set the frequency of the 6th stage in PLC program operation and multi-speed control.	40.00 Hz (0.00 Hz - maximum frequency)

◇ F14.06: PLC Multi-Speed 7

Parameter Code (Address)	Name	Description	Default (Range)
F14.06 (0x0E06) RUN	PLC Multi-Speed 7	V/F SVC FVC PMVF PMSVC PMFVC Set the frequency of the 7th stage in PLC program operation and multi-speed control.	30.00 Hz (0.00 Hz - maximum frequency)

◇ F14.07: PLC Multi-Speed 8

Parameter Code (Address)	Name	Description	Default (Range)
F14.07 (0x0E07) RUN	PLC Multi-Speed 8	V/F SVC FVC PMVF PMSVC PMFVC Set the frequency of the 8th stage in PLC program operation and multi-speed control.	20.00 Hz (0.00 Hz - maximum frequency)

◇ F14.08: PLC Multi-Speed 9

Parameter Code (Address)	Name	Description	Default (Range)
F14.08 (0x0E08) RUN	PLC Multi-Speed 9	V/F SVC FVC PMVF PMSVC PMFVC Set the frequency of the 9th stage in PLC program operation and multi-speed control.	10.00 Hz (0.00 Hz - maximum frequency)

◇ **F14.09: PLC Multi-Speed 10**

Parameter Code (Address)	Name	Description	Default (Range)
F14.09 (0x0E09) RUN	PLC Multi-Speed 10	V/F SVC FVC PMVF PMSVC PMFVC Set the frequency of the 10th stage in PLC program operation and multi-speed control.	20.00 Hz (0.00 Hz - maximum frequency)

◇ **F14.10: PLC Multi-Speed 11**

Parameter Code (Address)	Name	Description	Default (Range)
F14.10 (0x0E0A) RUN	PLC Multi-Speed 11	V/F SVC FVC PMVF PMSVC PMFVC Set the frequency of the 11th stage in PLC program operation and multi-speed control.	30.00 Hz (0.00 Hz - maximum frequency)

◇ **F14.10: PLC Multi-Speed 12**

Parameter Code (Address)	Name	Description	Default (Range)
F14.11 (0x0E0B) RUN	PLC Multi-Speed 12	V/F SVC FVC PMVF PMSVC PMFVC Set the frequency of the 12th stage in PLC program operation and multi-speed control.	40.00 Hz (0.00 Hz - maximum frequency)

◇ **F14.12: PLC Multi-Speed 13**

Parameter Code (Address)	Name	Description	Default (Range)
F14.12 (0x0E0C) RUN	PLC Multi-Speed 13	V/F SVC FVC PMVF PMSVC PMFVC Set the frequency of the 13th stage in PLC program operation and multi-speed control.	50.00 Hz (0.00 Hz - maximum frequency)

◇ **F14.13: PLC Multi-Speed 14**

Parameter Code (Address)	Name	Description	Default (Range)
-----------------------------	------	-------------	--------------------

F14.13 (0x0E0D) RUN	PLC Multi-Speed 14	V/F SVC FVC PMVF PMSVC PMFVC Set the frequency of the 14th stage in PLC program operation and multi-speed control.	40.00 Hz (0.00 Hz - maximum frequency)
---------------------------	-----------------------	--	---

◇ **F14.14: PLC Multi-Speed 15**

Parameter Code (Address)	Name	Description	Default (Range)
F14.14 (0x0E0E) RUN	PLC Multi-Speed 15	V/F SVC FVC PMVF PMSVC PMFVC Set the frequency of the 15th stage in PLC program operation and multi-speed control.	30.00 Hz (0.00 Hz - maximum frequency)

These 4 multi-speed control terminals are combined with ON/OFF of COM to control in which speed stage the frequency inverter is running. Its operation and direction are controlled by the motion signal and direction given by the command channel [F01.01]. Its acceleration and deceleration time is set as the acceleration and deceleration time 1 [F01.22] and [F01.23] by default. The acceleration and deceleration time can also be selected by choosing terminals based on the acceleration and deceleration time set through multi-functional input terminals [F05.00~F05.09].

Multi-Speed Terminal 4	Multi-Speed Terminal 3	Multi-Speed Terminal 2	Multi-Speed Terminal 1	Terminal
				Stage speed
OFF	OFF	OFF	ON	1X [F14.00]
OFF	OFF	ON	OFF	2X [F14.01]
OFF	OFF	ON	ON	3X [F14.02]
OFF	ON	OFF	OFF	4X [F14.03]
OFF	ON	OFF	ON	5X [F14.04]
OFF	ON	ON	OFF	6X [F14.05]
OFF	ON	ON	ON	7X [F14.06]
ON	OFF	OFF	OFF	8X [F14.07]
ON	OFF	OFF	ON	9X [F14.08]
ON	OFF	ON	OFF	10X [F14.09]
ON	OFF	ON	ON	11X [F14.10]
ON	ON	OFF	OFF	12X [F14.11]
ON	ON	OFF	ON	13X [F14.12]
ON	ON	ON	OFF	14X [F14.13]
ON	ON	ON	ON	15X [F14.14]

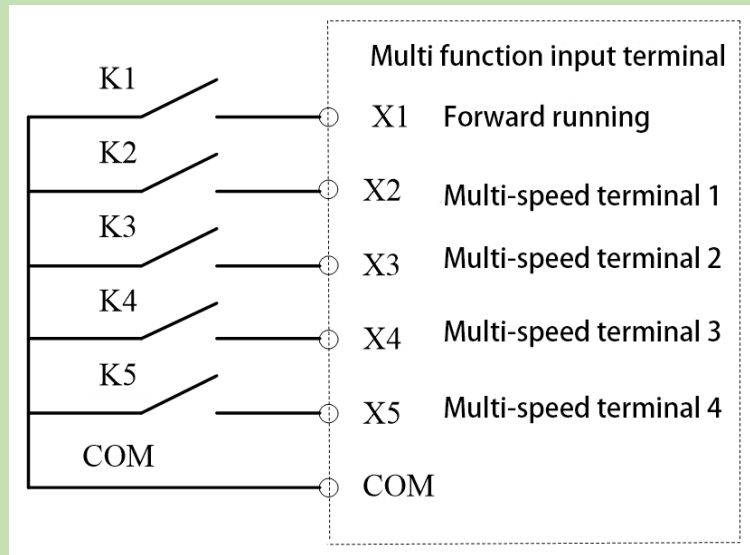

Terminal connection diagram

F14.15: PLC Running Mode Selection

◇ F14.15: PLC Running Mode Selection

Parameter Code (Address)	Name	Description	Default (Range)
F14.15 (0x0E0F) RUN	PLC running mode selection	V/F SVC FVC PMVF PMSVC PMFVC	0000 (0000~2122)

LED"0": Cycling method Used to select the PLC operation mode given by program control.

0: Stop after a single cycle After accepting an operation instruction, the frequency inverter starts running from the first stage speed, where the unit of time is set by the LED LED"00" in [F14.15]; the running time is set by parameters [F14.16~F14.30]; the running direction and acceleration and deceleration time are selected via parameters [F14.31~F14.45]; the frequency inverter will run at the next stage speed when the running time expires. The time, direction, and acceleration and deceleration time of operation of each stage speed can be set separately. The frequency inverter outputs "0" frequency after running at the 15th stage speed. If the running time of a certain stage is zero, that stage is skipped during operation.

1: Continuous cycle After running at the 15th stage speed, the frequency inverter returns to the 1st stage speed and restarts operation, without stopping the cycle. The unit of time is set by the LED LED"00" in [F14.15]; the running time is set by parameters [F14.16~F14.30]; the running direction and acceleration and deceleration time are selected via parameters [F14.31~F14.45].

2: Maintain the final value after a single cycle The frequency inverter will run continuously at the last stage speed where the running time is not zero without stop after running a single cycle. The unit of time is set by the LED LED"00" in [F14.15]; the running time is set by parameters [F14.16~F14.30]; the running direction and acceleration and deceleration time are selected via parameters [F14.31~F14.45].

LED"00": Timing unit Used to set the time unit for timing during program operation

0: Second (s)

1: Minute (m)

2: Hour (h)

LED"000": Power-off storage mode

0: Do not store

1: Store

This parameter is defined as whether the frequency inverter stores current program operation status (running stage, remaining time of this stage, acceleration and deceleration, and running direction, etc.) upon power-off when program operation is selected. If power-off storage is selected, the program operation restoration method following the next power-on can be defined in cooperation with the LED LED"0000" parameter in [F14.15]. You should set this parameter as "1" in order to ensure that the frequency inverter can resume its condition after an instantaneous power-off.

LED"0000": Start method

0: Re-run from stage one

1: Re- run from the stage of stop

2: Re-run from the remaining time of the stage upon stop last time

This parameter defines the operation mode during restart following interruption of the program operation process due to various reasons (stop, failure, blackout, etc.).

When "0" mode is selected, the frequency inverter will restart at the first stage speed.

When "1" mode is selected, the frequency inverter will time and run again using the running stage at the moment of interruption.

When "2" mode is selected, the frequency inverter will run with the running stage at the moment of interruption and according to the remaining time of that stage at the moment of interruption.

Note:

- The output frequency during program operation is restricted by the upper and lower frequency limits. When the set frequency is lower than the lower frequency limit, operation will start running at the lower limit frequency in [F01.13].

F14.16 - F14.30: PLC Running Time Selection

Used to set running times of 15 stage speeds respectively. The unit of time is determined by the set point of the LED"00" in [F14.15].

◇ F14.16: PLC 1st Stage Running Time

Parameter Code (Address)	Name	Description	Default (Range)
F14.16 (0x0E10) RUN	PLC segment 1 running time	V/F SVC FVC PMVF PMSVC PMFVC Set the running time for the 1st segment of PLC program.	10.0(s/m/h) (0.0(s/m/h)~ 6500.0(s/m/h))

◇ F14.17: PLC 2nd Stage Running Time

Parameter Code (Address)	Name	Description	Default (Range)
F14.17 (0x0E11) RUN	PLC segment 2 running time	V/F SVC FVC PMVF PMSVC PMFVC Set the running time for the 2nd segment of PLC program.	10.0(s/m/h) (0.0(s/m/h)~ 6500.0(s/m/h))

◇ F14.18: PLC 3rd Stage Running Time

Parameter Code (Address)	Name	Description	Default (Range)
F14.18 (0x0E12) RUN	PLC segment 3 running time	V/F SVC FVC PMVF PMSVC PMFVC Set the running time for the 3rd segment of PLC program.	10.0(s/m/h) (0.0(s/m/h)~ 6500.0(s/m/h))

◇ F14.19: PLC 4th Stage Running Time

Parameter Code (Address)	Name	Description	Default (Range)
F14.19 (0x0E13) RUN	PLC segment 4 running time	V/F SVC FVC PMVF PMSVC PMFVC Set the running time for the 4th segment of PLC program.	10.0(s/m/h) (0.0(s/m/h)~ 6500.0(s/m/h))

◇ F14.20: PLC 5th Stage Running Time

Parameter Code (Address)	Name	Description	Default (Range)
F14.20 (0x0E14) RUN	PLC segment 5 running time	V/F SVC FVC PMVF PMSVC PMFVC Set the running time for the 5th segment of PLC program.	10.0(s/m/h) (0.0(s/m/h)~ 6500.0(s/m/h))

◇ F14.21: PLC 6th Stage Running Time

Parameter Code (Address)	Name	Description	Default (Range)
F14.21 (0x0E15) RUN	PLC segment 6 running time	V/F SVC FVC PMVF PMSVC PMFVC Set the running time for the 6th segment of PLC program.	10.0(s/m/h) (0.0(s/m/h)~ 6500.0(s/m/h))

◇ F14.22: PLC 7th Stage Running Time

Parameter Code (Address)	Name	Description	Default (Range)
F14.22 (0x0E16) RUN	PLC segment 7 running time	V/F SVC FVC PMVF PMSVC PMFVC Set the running time for the 7th segment of PLC program.	10.0(s/m/h) (0.0(s/m/h)~ 6500.0(s/m/h))

◇ F14.23: PLC 8th Stage Running Time

Parameter Code (Address)	Name	Description	Default (Range)
F14.23 (0x0E17) RUN	PLC segment 8 running time	V/F SVC FVC PMVF PMSVC PMFVC Set the running time for the 8th segment of PLC program.	10.0(s/m/h) (0.0(s/m/h)~ 6500.0(s/m/h))

◇ F14.24: PLC 9th Stage Running Time

Parameter Code (Address)	Name	Description	Default (Range)
F14.24 (0x0E18) RUN	PLC segment 9 running time	V/F SVC FVC PMVF PMSVC PMFVC Set the running time for the 9th segment of PLC program.	10.0(s/m/h) (0.0(s/m/h)~ 6500.0(s/m/h))

◇ F14.25: PLC 10th Stage Running Time

Parameter Code (Address)	Name	Description	Default (Range)
F14.25 (0x0E19) RUN	PLC segment 10 running time	V/F SVC FVC PMVF PMSVC PMFVC Set the running time for the 10th segment of PLC program.	10.0(s/m/h) (0.0(s/m/h)~ 6500.0(s/m/h))

◇ **F14.26: PLC 11th Stage Running Time**

Parameter Code (Address)	Name	Description	Default (Range)
F14.26 (0x0E1A) RUN	PLC segment 11 running time	V/F SVC FVC PMVF PMSVC PMFVC Set the running time for the 11th segment of PLC program.	10.0(s/m/h) (0.0(s/m/h)~ 6500.0(s/m/h))

◇ **F14.27: PLC 12th Stage Running Time**

Parameter Code (Address)	Name	Description	Default (Range)
F14.27 (0x0E1B) RUN	PLC segment 12 running time	V/F SVC FVC PMVF PMSVC PMFVC Set the running time for the 12th segment of PLC program.	10.0(s/m/h) (0.0(s/m/h)~ 6500.0(s/m/h))

◇ F14.28: PLC 13th Stage Running Time

Parameter Code (Address)	Name	Description	Default (Range)
F14.28 (0x0E1C) RUN	PLC segment 13 running time	V/F SVC FVC PMVF PMSVC PMFVC Set the running time for the 13th segment of PLC program.	10.0(s/m/h) (0.0(s/m/h)~ 6500.0(s/m/h))

◇ F14.29: PLC 14th Stage Running Time

Parameter Code (Address)	Name	Description	Default (Range)
F14.29 (0x0E1D) RUN	PLC segment 14 running time	V/F SVC FVC PMVF PMSVC PMFVC Set the running time for the 14th segment of PLC program.	10.0s (0.0(s/m/h)~ 6500.0(s/m/h))

◇ F14.30: PLC 15th Stage Running Time

Parameter Code (Address)	Name	Description	Default (Range)
F14.30 (0x0E1E) RUN	PLC segment 15 running time	V/F SVC FVC PMVF PMSVC PMFVC Set the running time for the 15th segment of PLC program.	10.0(s/m/h) (0.0(s/m/h)~ 6500.0(s/m/h))

F14.31~F14.45: PLC Direction and Acceleration/Deceleration Time Selection

Used to set running directions and acceleration and deceleration times of 15 stage speeds respectively during program operation.

◇ F14.31: PLC 1st Stage Direction And Acceleration And Deceleration Time

Parameter Code (Address)	Name	Description	Default (Range)
F14.31 (0x0E1F) RUN	Direction and Acceleration/Deceleration Time of PLC Segment 1	V/F SVC FVC PMVF PMSVC PMFVC Used to set the running direction and acceleration and deceleration time of 1st stage.	0000 (0000~0031)

◇ F14.32: PLC 2nd Stage Direction And Acceleration And Deceleration Time

Parameter Code (Address)	Name	Description	Default (Range)
-----------------------------	------	-------------	--------------------

F14.32 (0x0E20) RUN	Direction and Acceleration/Deceleration Time of PLC Segment 2	V/F SVC FVC PMVF PMSVC PMFVC Used to set the running direction and acceleration and deceleration time of 2nd stage.	0000 (0000~0031)
---------------------------	---	--	---------------------

◇ F14.33: PLC 3rd Stage Direction And Acceleration And Deceleration Time

Parameter Code (Address)	Name	Description	Default (Range)
F14.33 (0x0E21) RUN	Direction and Acceleration/Deceleration Time of PLC Segment 3	V/F SVC FVC PMVF PMSVC PMFVC Used to set the running direction and acceleration and deceleration time of 3rd stage.	0000 (0000~0031)

◇ F14.34: PLC 4th Stage Direction And Acceleration And Deceleration Time

Parameter Code (Address)	Name	Description	Default (Range)
F14.34 (0x0E22) RUN	Direction and Acceleration/Deceleration Time of PLC Segment 4	V/F SVC FVC PMVF PMSVC PMFVC Used to set the running direction and acceleration and deceleration time of 4th stage.	0000 (0000~0031)

◇ F14.35: PLC 5th Stage Direction And Acceleration And Deceleration Time

Parameter Code (Address)	Name	Description	Default (Range)
F14.35 (0x0E23) RUN	Direction and Acceleration/Deceleration Time of PLC Segment 5	V/F SVC FVC PMVF PMSVC PMFVC Used to set the running direction and acceleration and deceleration time of 5th stage.	0000 (0000~0031)

◇ F14.36: PLC 6th Stage Direction And Acceleration And Deceleration Time

Parameter Code (Address)	Name	Description	Default (Range)
F14.36 (0x0E24) RUN	Direction and Acceleration/Deceleration Time of PLC Segment 6	V/F SVC FVC PMVF PMSVC PMFVC Used to set the running direction and acceleration and deceleration time of 6th stage.	0000 (0000~0031)

◇ F14.37: PLC 7th Stage Direction And Acceleration And Deceleration Time

Parameter Code (Address)	Name	Description	Default (Range)
F14.37 (0x0E25) RUN	Direction and Acceleration/Deceleration Time of PLC Segment 7	V/F SVC FVC PMVF PMSVC PMFVC Used to set the running direction and acceleration and deceleration time of 7th stage.	0000 (0000~0031)

◇ **F14.38: PLC 8th Stage Direction And Acceleration And Deceleration Time**

Parameter Code (Address)	Name	Description	Default (Range)
F14.38 (0x0E26) RUN	Direction and Acceleration/Deceleration Time of PLC Segment 8	V/F SVC FVC PMVF PMSVC PMFVC Used to set the running direction and acceleration and deceleration time of 8th stage.	0000 (0000~0031)

◇ F14.39: PLC 9th Stage Direction And Acceleration And Deceleration Time

Parameter Code (Address)	Name	Description	Default (Range)
F14.39 (0x0E27) RUN	Direction and Acceleration/Deceleration Time of PLC Segment 9	V/F SVC FVC PMVF PMSVC PMFVC Used to set the running direction and acceleration and deceleration time of 9th stage.	0000 (0000~0031)

◇ F14.40: PLC 10th Stage Direction And Acceleration And Deceleration Time

Parameter Code (Address)	Name	Description	Default (Range)
F14.40 (0x0E28) RUN	Direction and Acceleration/Deceleration Time of PLC Segment 10	V/F SVC FVC PMVF PMSVC PMFVC Used to set the running direction and acceleration and deceleration time of 10th stage.	0000 (0000~0031)

◇ F14.41: PLC 11th Stage Direction And Acceleration And Deceleration Time

Parameter Code (Address)	Name	Description	Default (Range)
F14.41 (0x0E29) RUN	Direction and Acceleration/Deceleration Time of PLC Segment 11	V/F SVC FVC PMVF PMSVC PMFVC Used to set the running direction and acceleration and deceleration time of 11th stage.	0000 (0000~0031)

◇ F14.42: PLC 12th Stage Direction And Acceleration And Deceleration Time

Parameter Code (Address)	Name	Description	Default (Range)
F14.42 (0x0E2A) RUN	Direction and Acceleration/Deceleration Time of PLC Segment 12	V/F SVC FVC PMVF PMSVC PMFVC Used to set the running direction and acceleration and deceleration time of 12th stage.	0000 (0000~0031)

◇ F14.43: PLC 13th Stage Direction And Acceleration And Deceleration Time

Parameter Code (Address)	Name	Description	Default (Range)
F14.43 (0x0E2B) RUN	Direction and Acceleration/Deceleration Time of PLC Segment 13	V/F SVC FVC PMVF PMSVC PMFVC Used to set the running direction and acceleration and deceleration time of 13th stage.	0000 (0000~0031)

◇ F14.44: PLC 14th Stage Direction And Acceleration And Deceleration Time

Parameter Code (Address)	Name	Description	Default (Range)
F14.44 (0x0E2C) RUN	Direction and Acceleration/Deceleration Time of PLC Segment 14	V/F SVC FVC PMVF PMSVC PMFVC Used to set the running direction and acceleration and deceleration time of 14th stage.	0000 (0000~0031)

◇ **F14.45: PLC 15th Stage Direction And Acceleration And Deceleration Time**

Parameter Code (Address)	Name	Description	Default (Range)
F14.45 (0x0E2D) RUN	Direction and Acceleration/Deceleration Time of PLC Segment 15	V/F SVC FVC PMVF PMSVC PMFVC Used to set the running direction and acceleration and deceleration time of 15th stage.	0000 (0000~0031)

LED"0": running direction of this stage

0: Forward

1: Reverse

Note: when the running direction is in reverse, you must set the F07.05 LED"00" as 0 and the F07.05 LED"000" as 1.

LED"00": Acceleration/deceleration time of this stage

0: Acceleration/deceleration time 1

1: Acceleration/deceleration time 2

2: Acceleration/deceleration time 3

3: Acceleration/deceleration time 4

LED"000": Reserved

LED"0000": Reserved

6.17 Group F15: Reserved

6.18 Group F21: Solar Pump Special Parameters

This group of parameters is mainly applied to the special parameter group of photovoltaic industry. If photovoltaic water pump is used, please mainly debug this parameter.

F21.00 : Solar Pump drive control mode

Function code number	Function code name	Set value range and definition	Factory setting	Some instructions	Communication address
----------------------	--------------------	--------------------------------	-----------------	-------------------	-----------------------

F21.00	Solar pump drive control mode	<p>LED0 Mode selection</p> <p>0: Frequency conversion mode</p> <p>1: CVT mode</p> <p>2: MPPT mode</p> <p>LED1 work selection</p> <p>0: continuous operation</p> <p>1: intermittent operation</p> <p>2: cleaning water pump (keyboard displays CLRER)</p> <p>LED2 reserved</p> <p>LED3 motor selection</p> <p>0: three-phase motor</p> <p>1: single-phase motor</p>	0x0002	<p>Note:</p> <p>1. When LED1 is set to 1 (intermittent operation) or set to 2 (water pump cleaning), the execution must be valid when LED0 is set to CVT or MPPT mode. When 2 is selected to "clean the water pump", this bit will automatically be executed after the execution is completed. If it is cleared, this bit will also be automatically cleared when the machine is stopped during cleaning.</p> <p>2. When LED3 is selected as a single-phase motor, parameter F08.00=5, F10.20 ones digit is set to 0, F21.14=30, F21.16=300 will be automatically configured.</p>	0xE00
--------	-------------------------------	--	--------	---	-------

Inverter speed control mode: Photovoltaic control does not work: if you need to run in normal mode, set it to inverter speed regulation mode. Turn off the photovoltaic water pump mode. At this time, the inverter can only perform a single frequency conversion and voltage regulation, it can control the machine to start and stop and change the speed, but the photovoltaic function parameters cannot be applied.

CTV mode: CVT (Constant Voltage Tracking) is constant voltage tracking, by adjusting the output frequency, the bus

voltage is stabilized at a given operating point; the frequency command generated by the CVT module is sent to the inverter circuit to realize the speed control of the motor.

The bus voltage is given as a constant value mode, and the CTV target voltage value is in the form of a percentage, which is compared with the percentage of the machine's open circuit voltage - the bus voltage during standby, by comparing this value with the voltage generated by the photovoltaic, and then calculate Whether the inverter needs to be down-frequency or up-frequency;

MPPT mode: MPPT (Maximum Power Point Tracking) is the maximum power point tracking, searching for the maximum power point according to the bus voltage V_{pn} and operating frequency, and outputting the bus voltage target value V_{pn}^* at the maximum power point.

MPPT Mode running process

1.1 Start acceleration and deceleration stage: Acceleration at the rate set by acceleration and deceleration time 1 (with the maximum frequency as the time reference). Due to the difference between the solar power panel and the power grid, with the increase of the output frequency of the inverter, the bus voltage will continue to decrease. If it runs to a given frequency, the bus voltage still does not drop to the CVT target voltage value (F21.03), then it keeps running at constant speed during the start-up and deceleration phase.

1.2 Until the current bus voltage reaches the turning point (set value + 8.0%*Voc), the acceleration slows down, and enters the CVT stage after reaching the voltage set value.

1.3 CVT stage: Adjust the frequency according to the error between the given and feedback, keep the bus constant, the gain is determined by F21.06 (frequency adjustment gain), the default value of 10.0% is the best setting; if the output frequency reaches the given frequency, Then exit the CVT stage and enter the start-up acceleration and deceleration stage, because the power of the battery board is sufficient to support the full-load operation of the motor; when the output frequency does not reach the given frequency, after the CVT is adjusted and stabilized (the voltage deviation is less than 5.0%) to enter the MPPT stage;

1.4. MPPT stage: Take the MPPT search interval (F21.07) as the period to search for the maximum power point.

Continuous operation: The inverter is always in the running state, and the photovoltaic voltage is always detected and compared with the bus voltage to run the water pump.

Indirect operation: intermittent operation of functional logic

1.1. This function is mainly used in the field where some farmland does not need to be irrigated all the time, and the irrigation is controlled by intermittent operation.

1.2. When F21.00 tenth digit is set to 1, the intermittent operation function will be opened. After opening, press the operation key to run the intermittent operation start time set in F21.55.

1.3. After the running completion time is reached, it is fixed to decelerate to 0Hz according to the deceleration stop method (F01.10with F21.53Ten digit is selected as free stop or deceleration stop), maintain the intermittent operation stop time set

in F21.56 at 0Hz, and then run again until the number of intermittent operation repeats set in F21.54 is reached.

1.4, When one of the parameters of F21.55 intermittent operation start time or F21.56 intermittent operation stop time is set to 0, intermittent operation will not be performed.

1.5. When setting the ones digit of F21.53 to 1, the next time it starts to run, it will continue to run in the running state before the last power failure (the number of repetitions of the previous shutdown, the time of the running phase or the time of the stop phase), when it is set to 0, When set to 0, it will run again after re-powering.

1.6. Deceleration to 0Hz when the tenth digits of F21.53 is set to "0" for Photovoltaic specific alarm output, and the output will be stopped immediately when set to "1".

Cleaning the water pump: The logic of the pump cleaning function

1.1. The pump stall (pump cleaning) function is defined as the function to remove impurities from the water pump.

1.2. After setting F21.00's tenth digits to 2, press the Run key, and the keyboard will display ClrEr. At this time, it will enter the pump cleaning state.

1.3. During cleaning, it will run to the cleaning set frequency (F21.57) according to the acceleration time 1. First run F14.58 in the forward direction and then decelerate to 0Hz. Wait for 2s before running F21.59 in the reverse direction to clean the reverse operation time.

1.4. One cycle of forward and reverse operation is counted as one cycle, and the shutdown state is restored after the set cleaning cycle number F21.60 is run.

1.5. If the stop button is pressed during the pump cleaning, the cleaning process will be stopped immediately, and the machine will be stopped according to the currently set stop mode; Whether the pump cleaning process is completed or the pump is stopped midway, the ten positions of F21.00 will be reset after the completion.

1.6. When any parameter from F21.57 to F21.60 is set to 0, this function will not be executed, and no current will be output at 0 speed. Test record: 1. When the frequency is 0, the keyboard does not display CLERE, and the current is not output when the frequency is 0. After manual shutdown, the tenth digit of F21.00 will not be reset. 2. It is the same when the forward and reverse rotation time is 0; 3. It is the same if the number of times is set to 0.

Three-phase motor: For the motor we normally use, 380V three-phase motor does not need to set other parameters.

Single-phase motors:

1.1. It is troublesome for customers to set single-phase motor parameters every time, so a macro parameter is set to facilitate customers to change parameters,

1.2. When the hundreds digit of F21.00 is set to 1, F08.00 (V/F curve selection) will be automatically set to 5; F10.20 bit (output phase loss protection) is set to 0; F21.14 (detection frequency of low frequency protection) is set to 30Hz; F21.16 (Automatic recovery time of low frequency protection) is set to 300s.

1.3 When F21.00 is switched to 0, the above four parameters will change back to the values before change.

Verify it and enter it manually if it has not changed.

F21.01 : Running control mode

Function code number	Function code name	Set value range and definition	Factory setting	Some instructions	Modify properties	Communication address
F21.01	Running control mode	0: Stop 1: Run 2: Sleep 3: Low frequency protection 4: dry running protection 5: Overcurrent protection 6: Low power protection 7: Water full protection	0 (read only)		R	0xE01

Used to read the operating status of the inverter to determine whether there is a fault in the motor operation (only read)

F21.02~F21.10: Running gain and adjustment

Function code number	Function code name	Set value range and definition	Factory setting	Some instructions	Modify properties	Communication address
F21.02	VOC voltage (display)	0.0V - 999.9V	0.1V (read only)		X	0xE02

Voc is the open-circuit voltage. The Voc is equal to the bus voltage during shutdown and is used to read parameters.

Function code number	Function code name	Set value range and definition	Factory setting	Some instructions	Modify properties	Communication address
F21.03	CVT	70.0% -	81.0%		X	0xE03

	target voltage	95.0%				
--	-------------------	-------	--	--	--	--

Applied to CTV mode parameters, CVT target voltage = percentage value * static open circuit voltage. Compared with the bus voltage, the frequency is increased below the target voltage frequency, and the frequency is decreased above the target voltage.

Function code number	Function code name	Set value range and definition	Factory setting	Some instructions	Modify properties	Communication address
F21.04	MPPT voltage upper limit	20.0% - 200.0%	100.0%		Y	0xE04
F21.05	MPPT voltage lower limit	20.0% - 200.0%	50.0%		Y	0xE05

The upper and lower limits of the voltage in MPPT mode, the customer can select the upper and lower limit values according to the requirements, the inverter will search for the maximum power point according to the operating frequency and output the target value of the bus voltage at the maximum power point;

Function code number	Function code name	Set value range and definition	Factory setting	Some instructions	Modify properties	Communication address
F21.06	Frequency adjustment gain	0.1% - 500.0%	10.0%		Y	0xE06
F21.07	MPPT search interval	0.1 - 30.0	1.0sec		Y	0xE07

The gain adjustment of frequency change mainly means that when the frequency is close to the target voltage, the frequency changes slowly, and increasing the gain can make the frequency change rapidly (the test found that 10% is the best);

In MPPT mode, the time interval for cycle frequency adjustment can be set;

Function	Function	Set value	Factory	Some	Modify	Communication
----------	----------	-----------	---------	------	--------	---------------

code number	code name	range and definition	setting	instructions	properties	address
F14.08	MPPT gain	0-9999	100		Y	0xE08
F14.09	Fast frequency reduction gain	0-20	2		Y	0xE09

MPPT gain: Make the MPPT operating situation respond faster and feedback more quickly. At the same time, when it can run stably in MPPT mode, increasing the gain can appropriately increase the output frequency and voltage stability. (Do not debug at will)

Fast throttling gain: speed guidance for throttling.

Function code number	Function code name	Set value range and definition	Factory setting	Some instructions	Modify properties	Communication address
F21.10	Frequency adjustment filter time	0.001s - 2.000s	0.020s		Y	0xE0A

When the voltage is stable, the frequency fluctuation can increase the filtering time appropriately.

F21.11~F21.13: Sleep protection function

Function code number	Function code name	Set value range and definition	Factory setting	Some instructions	Modify properties	Communication address
F21.11	Sleep voltage threshold	0 to 1000V	0V	Display A.LPn when alarming, set F21.11 to 0 to close sleep	Y	0xE0B
F21.12	Sleep recovery voltage	0 to 1000V	400V		Y	0xE0C
F21.13	Sleep shutdown	0.0sec~ 3000.0sec	10.0sec		Y	0xE0D

	waiting time					
--	-----------------	--	--	--	--	--

Sleep logic: Set according to customer requirements

- 1.1. When the frequency is in operation and the bus voltage is less than F21.11 sleep voltage threshold, report A.LPn warning immediately.
- 1.2. After the alarm, the inverter will decelerate or stop freely according to the tenth digit setting of F21.53.
- 1.3. When the bus voltage rises to F21.12 sleep recovery voltage, after F21.13 sleep shutdown waiting time, the inverter starts to operate from zero frequency (free shutdown) or from the current frequency (deceleration shutdown).
- 1.4. If F21.11 sleep voltage is set to 0, turn off low voltage protection.
- 1.5. The low voltage protection can still be triggered under the state of deceleration shutdown. After the protection is triggered, the shutdown will be carried out according to the tenth digit setting of F21.53, and the operation will not be resumed after the shutdown.
- 1.6. If the voltage drops to the sleep voltage again during the sleep shutdown waiting time, the inverter will not resume operation. Each detection time is independent of each other and will not be accumulated.

F21.14~F21.16: Low frequency protection function

Function code number	Function code name	Set value range and definition	Factory setting	Some instructions	Modify properties	Communication address
F21.14	Detection frequency of low frequency protection	0.00Hz ~ 300.00Hz	0.00Hz	In case of alarm, A.LFr is displayed, and F21.14 is set to 0 to turn off low frequency protection Judgment time of low frequency protection exit	Y	0xE0E
F21.15	Detection time of low frequency protection	0.0sec ~ 3000.0sec	10.0sec		Y	0xE0F
F21.16	Automatic recovery	0.0sec ~ 3000.0sec	10.0sec		Y	0xE10

	time of low frequency protection			is related to F21.16 Low frequency protection does not increase sleep times F21.16		
--	---	--	--	--	--	--

Low frequency protection

- 1.1. When the inverter is in CVT regulation state and the output frequency is less than the frequency detected by F21.14 low frequency protection, the A.LFr warning is reported after F21.15 low frequency protection detection time.
- 1.2. After the alarm, the inverter will decelerate or stop freely according to the tenth digit setting of F14.53.
- 1.3. From the alarm alarm point, after F21.16 low frequency protection automatic recovery time, the inverter starts to operate from the current frequency.
- 1.4. If the detection frequency of F21.14 low frequency protection is set to 0, the low-voltage protection is closed.
- 1.5. Low frequency protection can still be triggered under the state of deceleration shutdown. After the protection is triggered, the shutdown will be carried out according to the tenth digit setting of F21.53, and the operation will not be resumed after the shutdown.
- 1.6. If the frequency increases to above the detected frequency of low frequency protection within the detection time of low frequency protection, the inverter will not alarm the low frequency protection warning, and each detection time is independent of each other and will not be accumulated.

F21.17~F21.19: Dry protection function

Function code number	Function code name	Set value range and definition	Factory setting	Some instructions	Modify properties	Communication address
F21.17	Detection current of dry running protection	0.0 - 999.9A	0.0A	The alarm displays A.LuT, and the dry running protection is	Y	0xE11
F21.18	Detection time of	0.0sec~ 3000.0sec	10.0sec	turned off	Y	0xE12

	dry running protection			when F21.17 is set to 0 100.0% corresponding motor rated current		
F21.19	Automatic recovery time of dry running protection	0.0sec~ 3000.0sec	10.0sec		Y	0xE13

Dry running protection: In order to protect the water pump, the current is kept very low, which will seriously affect the motor.

1. Dry running protection 1 logic

1.1. When the inverter is in operation, the F21.29 thousands digit is zero and there is no sensor and the output current is less than F21.17 after hitting the dry running protection detection point, the A.LuT alarm is reported after F21.18 dry running detection time.

1.2. After the alarm, the inverter will decelerate or stop freely according to the tenth digit setting of F21.53.

1.3. The timing starts after the alarm. After the F21.19 dry running protection recovery delay, the inverter starts to run from the current frequency.

1.4. If F21.17 dry running protection detection point is set to 0, the dry running protection is closed.

1.5. The dry running protection can still be triggered under the deceleration shutdown state, after the protection is triggered, the machine will be shutdown according to the tenth digit setting of F21.53. After the shutdown, the machine will not resume operation again.

1.6. If the output current increases above the protection point within the detection time of dry running protection, it will not enter the dry running protection again. Each detection time is independent of each other and will not be accumulated.

2. Dry running protection 2 logic

2.1. When the inverter is in operation, F21.29 thousands digit has a sensor, and any X terminal input function is set to 83 and is effective, the detection stage of dry running protection will enter, and other logic is the same as that of dry running protection 1.

F21.20~F21.22: Overcurrent protection function

Function code number	Function code name	Set value range and definition	factory setting	Some instructions	Modify properties	Communication address
F21.20	Detection current of overcurrent protection	0.0 - 999.9A	0.0A	Display A.Old in case of alarm F21.20 Turn off overcurrent protection when it is set to 0	Y	0xE14
F21.21	Detection time of overcurrent protection	0.0sec~ 3000.0sec	10.0sec		Y	0xE15
F21.22	Automatic recovery time of overcurrent protection	0.0sec~ 3000.0sec	10.0sec		Y	0xE16

Overcurrent protection: Overcurrent protection parameters

- 1.1. When the inverter is in operation and the output current is greater than F21.20 overcurrent protection detection point, the A.Old alarm is reported after F21.21 overcurrent detection protection time.
- 1.2. After the alarm, the inverter will decelerate or stop freely according to the tenth digit setting of F21.53.
- 1.3. Start timing after the alarm. After F21.22 overcurrent protection recovery delay, the inverter starts to run from the current frequency.
- 1.4. If F21.20 overcurrent protection detection point is set to 0, the overcurrent protection is closed.
- 1.5. The overcurrent protection can still be triggered under the state of deceleration shutdown. After the protection is triggered, the shutdown will be carried out according to the tenth digit setting of F21.53, and the operation will not be resumed after the shutdown.
- 1.6. If the output is reduced below the protection point within the detection time of overcurrent protection, it will not enter the overcurrent protection again. Each detection time is independent of each other and will not be accumulated.

F21.23~F21.25: Minimum power protection function

Function	Function	Set value	Factory	Some	Modify	Communication
----------	----------	-----------	---------	------	--------	---------------

code number	code name	range and definition	setting	instructions	properties	address
F21.23	Minimum power protection value	0.00kw - 650.00kw	0.00kw	Display A.LPr in case of alarm, F21.23 Turn off the minimum power protection when it is set to 0	Y	0xE17
F21.24	Minimum power protection detection time	0.0sec~ 3000.0sec	10.0sec		Y	0xE18
F21.25	Minimum power protection automatic recovery time	0.0sec~ 3000.0sec	10.0sec		Y	0xE19

Minimum power protection: It is also to protect the water pump, when the running current is small, the power is relatively small. From different dimensions.

1.1. When the inverter is in operation and the output power is less than F21.23 minimum power protection detection point, report A.LPr after F21.24 minimum power protection detection time.

1.2. After the alarm, the inverter will decelerate or stop freely according to the tenth digit setting of F21.53.

1.3. The timing starts after the alarm. After the F21.25 minimum power protection recovery delay, the inverter starts to run from the current frequency.

1.4. If F21.23 minimum power protection detection point is set to 0, the minimum power protection is closed.

1.5. The minimum power protection can still be triggered under the state of deceleration shutdown. After the protection is triggered, the shutdown will be carried out according to the tenth digit setting of F21.53, and the operation will not be resumed after the shutdown.

1.6. If the output power increases above the protection point within the minimum power protection detection time, the minimum power protection will not be entered again. Each detection time is independent of each other and will not be accumulated.

F21.26: Alarm recovery mode

Function code number	Function code name	Set value range and definition	Factory setting	Some instructions	Modify properties	Communication address
F21.26	Alarm recovery mode	0: Automatic recovery; 1: Manual recovery LED0: Low frequency protection LED1: dry running protection LED2: overcurrent overload protection LED 3: minimum power protection	0000H	If set to manual recovery, The recovery time of various protections is invalid	Y	0xE1A

When the protection alarm is triggered, automatic recovery and manual recovery can be selected according to this parameter. The automatic recovery time of the corresponding protection for manual recovery is invalid, and the automatic recovery will be used normally again according to the time. During the fault warning display, you can also press and hold the "RESET" key to stop the machine; When 1 is selected for manual recovery, the fault alarm can be cleared manually by pressing the "RESET" key, or the shutdown operation can be realized by long pressing the "RESET" key.

F21.27~F21.28: Water full protection function

Function code No	Function code name	Set value range and definition	Factory setting	Some instructions	Modify properties	Communication address
------------------	--------------------	--------------------------------	-----------------	-------------------	-------------------	-----------------------

F21.27	Detection time of water full protection	0.0sec~ 3000.0sec	10.0sec	Display A.FuL in case of alarm	Y	0xE1B
F21.28	Exit time of water full protection	0.0sec~ 3000.0sec	10.0sec	Turn off water full protection when set to 0	Y	0xE1C

Full water protection: It is used to draw water from the pool to judge the water level.

Water full protection logic

1.1. During field use, there are two water full detection points, namely upper limit and lower limit. When the water volume exceeds the upper limit, the water full protection will be triggered. When the water volume drops below the lower limit, the water full protection phase will be exited to achieve the hysteresis effect.

1.2. Therefore, in the function code of terminal X, 80: photovoltaic water full detection alarm is the upper limit, and 81: photovoltaic water full detection alarm reset is the lower limit. When the water volume reaches the upper limit, the lower limit will be triggered; When exiting the lower limit, it must exit the upper limit. Therefore, when the two terminals are effective at the same time, the water full protection alarm will enter. If it is invalid at the same time, exit the water full protection alarm.

1.3. When the inverter is in operation and both terminals are valid at the same time, after F21.27 water full detection time, report A.FuL alarm. After the alarm is reported, the inverter will decelerate or stop freely according to F21.53 tenth digit setting.

1.4. If F21.27 water full detection time is set to 0, turn off water full protection.

1.5. Start timing after the alarm. After F21.28 water full protection recovery delay, the inverter starts running from the current frequency.

1.6. The water full protection can still be triggered under the state of deceleration shutdown. After the protection is triggered, the shutdown will be carried out according to the tenth digit setting of F21.53, and the operation will not be resumed after the shutdown.

1.7. If the water level drops below the lower limit during the detection time of water full protection, it will not enter the water full protection again, and each detection time is independent of each other and will not be accumulated.

F21.29~F21.52: Other functions

Function	Function	Set value	Factory	Some	Modify	Communication
----------	----------	-----------	---------	------	--------	---------------

code number	code name	range and definition	setting	instructions	properties	address
F21.29	Auxiliary functions	<p>0: invalid, 1: valid</p> <p>LED0:0: upper limit is limited by given frequency, 1: upper limit frequency is limited by rated frequency of motor</p> <p>LED1:0: lower limit minimum to 0 1: lower limit frequency minimum to 1/4 of motor rated frequency</p> <p>LED2: fault power-off storage</p> <p>LED 3: dry running out protection</p>	0110H	<p>Note: When LED 3 is selected as 2, it means that the current is judged to be dry running. When the current is in dry running protection, the current output frequency is reduced to 7% of the rated frequency. In this case, the current rises>F21.20+ 0.4A (0.4 is hysteresis), and the dry running protection exits, and the frequency recovers.</p>	Y	0xE1D

		<p>selection</p> <p>0: Sensorless protection (current judgment)</p> <p>1: With sensor protection</p> <p>2: Slow down operation (single-phase motor disabled)</p>				
--	--	--	--	--	--	--

Auxiliary parameter setting, according to other functions to set this parameter

Function code number	Function code name	Set value range and definition	Factory setting	Some instructions	Modify properties	Communication address
F21.30	DC current derivation offset	0-99.99A	0.00A		Y	0xE1E
F21.31	DC current extrapolation gain	0-999.9%	100.0%		Y	0xE1F

If you find that the DC current is not detected correctly, you can adjust F21.30 and F21.31 for recalibration.

Function code number	Function code name	Set value range and definition	Factory setting	Some instructions	Modify properties	Communication address
F21.32	Power curve point 0	0.00kw - 99.99kw	0.50kw		Y	0xE20
F21.33	Power curve point 1	0.00kw - 99.99kw	1.00kw		Y	0xE21

F21.34	Power curve point 2	0.00kw - 99.99kw	1.50kw		Y	0xE22
F21.35	Power curve point 3	0.00kw - 99.99kw	2.00kw		Y	0xE23
F21.36	Power curve point 4	0.00kw - 99.99kw	2.50kw		Y	0xE24
F21.37	Flow curve point 0	0.0 - 999.9m ³ /h	0.0 m ³ /h		Y	0xE25
F21.38	Flow curve point 1	0.0 - 999.9m ³ /h	5.0 m ³ /h		Y	0xE26
F21.39	Flow curve point 2	0.0 - 999.9m ³ /h	10.0m ³ / h		Y	0xE27
F21.40	Flow curve point 3	0.0 - 999.9m ³ /h	15.0m ³ / h		Y	0xE28
F21.41	Flow curve point 4	0.0 - 999.9m ³ /h	20.0m ³ / h		Y	0xE29
F21.42	Flow calculation correction offset	0.0m ³ - 999.9 ³	0.0m ³		Y	0xE2A
F21.43	Flow calculation correction gain	0.1% - 500.0%	100.0%		Y	0xE2B
F21.44	Daily flow/daily power clearing cycle	0.1 - 24.0Hr	7.0Hr		Y	0xE2C
F21.45	Reserved	0-9999	0		Y	0xE2D

PQ curve function

This model provides custom PQ curve, which can be used by users to set 5 groups of PQ correspondence points according

to the water pump situation to realize real-time flow rate, daily flow rate, cumulative flow rate, daily power generation and cumulative power consumption calculation; among them, by default, daily flow rate and daily power generation are calculated in a 7h day.

Function code number	Function code name	Set value range and definition	Factory setting	Some instructions	Modify properties	Communication address
F21.46	Photovoltaic pump function selection 1	0: invalid, 1: effective LED0: constant torque frequency limiting selection LED1: reserved LED2: voltage surge update Voc voltage LED3: fast downscaling function	1100H		Y	0xE2E

Constant torque frequency limit selection: The application is used in the field where the torque is constant all the time. When the torque is constant and the load is small, the frequency will increase all the time and we need to set a limit value to it to do the limitation, then this value can be designed.

Constant torque frequency limiting function logic

- 1.1. When setting 21.46 digits: The function is turned on when constant torque frequency limit is selected as 1.
- 1.2. The output voltage and frequency are limited by setting F21.48 Constant Torque Frequency Limiting.
- 1.3. If the set value is less than or equal to 100%, the output voltage and output frequency will be limited according to the set percentage * current bus voltage.
- 1.4. If the setting value is greater than 100%, the output voltage will be limited to 100%, i.e. the maximum output voltage cannot exceed the current bus voltage/1.414, but the output frequency will continue to increase proportionally. **Voltage**

surge update Voc voltage: Voc is the open circuit voltage, the size of Voc is equal to the bus voltage during shutdown, the Voc voltage is projected and continuously updated slowly according to the current bus voltage during operation, and when the bus voltage suddenly rises, a large update of the Voc voltage is required immediately to ensure the normal operation of the PV system.

1.1. When F21.46 hundred is selected as 1, the function of updating Voc voltage by voltage surge is turned on. When the bus voltage exceeds the voltage surge threshold F21.49, this function is valid and the Voc voltage is updated immediately.

Fast downscaling function: When the photovoltaic normal operation process, suddenly encounter a dark cloud shading, then the panel power will be significantly reduced, the bus voltage will fall quickly, in order to prevent the sudden bus voltage change to pull the inverter crotch, use this function to adjust the output frequency quickly down.

1.1. Set F21.46 kilobits to 1 to turn on the fast frequency reduction function. When the voltage drop exceeds the F21.47 fast frequency reduction threshold, it enters the fast frequency reduction process and the output frequency drops rapidly to 3Hz.

1.2. After maintaining 1s at 3Hz, if Voc does not change significantly, continue to reduce to 0Hz to maintain 4s, and after 4s restart with the start acceleration phase.

1.3. After starting with the acceleration phase, if there is no big change in Voc, when it enters CVT mode, it will enter 3Hz fast downscaling mode again and repeat the cycle.

1.4. After the dark clouds pass and the bus voltage rises significantly to perform the start-up in an accelerated phase, it enters the normal operation phase.

Function code number	Function code name	Set value range and definition	Factory setting	Some instructions	Modify properties	Communication address
F21.47	Fast downsampling threshold	3.0%-15.0%	5.0%		Y	0xE2F
F21.48	Constant torque frequency limiting	80.0%-150.0%	100.0%		Y	0xE30
F21.49	Voltage Surge Threshold	0.0%-20.0%	5.0%		Y	0xE31
F21.50	Reserved	1-40	10		Y	0xE32
F21.51	Reserved				Y	0xE33
F21.52	Reserved				Y	0xE34

The above parameters are operated according to the PV pump function selection. The specific requirements and operations can be based on the above parameters explained for parameter selection.

F21.53~F21.60: Motor setting operation function

Function code number	Function code name	Set value range and definition	Factory setting	Some instructions	Modify properties	Communication address
F21.53	Intermittent operation and alarm shutdown settings	<p>LED0: intermittent operation storage options 0: no storage 1: storage</p> <p>LED1: Alarm output stop selection 0: speed reduction to 0Hz 1: stop output immediately</p> <p>LED2: Reserved LED3: Reserved</p>	0x0000	<p>1、 When LED0 selects "1" for storage, the next start-up operation will continue to run in the same state as before the last power-down (the number of repetitions of the previous stop, the running phase time or the stop phase time), otherwise it will run again and the number of repetitions</p>	X	0xE35

				will be cleared to zero. 2、LED1 is set to "0" to decelerate to 0Hz when the PV special alarm output is set to F0.15 to set the deceleration time, and "1" to stop the output immediately.		
F21.54	Number of repetitions of intermittent operation	0~1000times	0	One of the parameters from F21.55 to F21.56 set	Y	0xE36
F21.55	Intermittent operation opening time	0~3000minutes	0	to 0 will not perform intermittent	Y	0xE37
F21.56	Intermittent running stop time	0~3000minutes	0	work, and F21.54 set to 0 will run in a loop all the time.	Y	0xE38
F21.57	Cleaning setting frequency	0.00Hz~300.00Hz	25.00Hz		Y	0xE39
F21.58	Cleaning	0~3000s	30	F21.57 to	Y	0xE3A

	positive running time			F21.60 One of the parameters set to 0 will not perform cleaning.		
F21.59	Cleaning reverse running time	0~3000s	30		Y	0xE3B
F21.60	Number of cleaning cycles	0~60times	5		Y	0xE3C

The above parameters are mainly selected according to the F21.00 function, the function is turned on and then debug parameters here, please check the F21.00 guidance notes for specific operations.

F21.61~F21.63: Power function

Function code number	Function code name	Set value range and definition	Factory setting	Some instructions	Modify properties	Communication address
F21.61	Power upper limit	0.0~ 1000.0	0.0	Set to 0 to run without limiting the power limit	Y	0xE3D
F21.62	Power limit Kp	0.0~100.0	1.0		Y	0xE3E
F21.63	Power limit Ki	0.0~100.0	1.0		Y	0xE3F

Power Limit: Parameters used to control the output power

The power limit is determined by F21.61-F21.63, and the power limit function is turned off when F21.61 is 0. Set the upper power limit value of F21.61 and adjust F21.62 and F21.63 so that the output power during operation cannot exceed the value set by F21.61. The power display is changed to kW effective.

Chapter 7 Operation Guidance

7.1 Asynchronous Motor Pump Drive Operation Guidance

1) Wiring

- a. Confirmed the solar pump drive if matching with motor.
- b. Correctly connecting “+”“-” of solar panel to R, T wiring terminals. Otherwise it will cause VFD damage.
- c. Connect motor wire and ground wire to corresponding U, V, W, E terminals.

2) Parameters setting and trial run

- a. Set F01.00 to 0, F01.02 for 0, and F01.22, F01.23 parameters setting according to application site.
- b. Set motor(pump) parameters according to nameplate of pump.
- c. Set solar pump MPPT mode F21.00 for 1 or 2.
- d. Press FWD button for trial running, and confirm the motor running direction.

3) Common problems

- a. Q:Well-lit conditions, the pump is running, but the water is very small.
A:Check if the pump motor direction is reversed.
- b. Q:Well-lit conditions, the drive is in standby mode 0.00Hz.
A:Check F21.01, observe what protection status is the drive in currently, check whether the parameters set is reasonable.
- c. Q:DC current is incorrectly displayed.
A:Adjust F21.30, F21.31 for calibration.
- d. Q:Well-lit conditions, frequency severe beating during operation.
A:Reasonably adjust F21.06 value, the adjustment is recommended to be in the vicinity of the default, too big or too small will cause frequency oscillation.

7.2 Synchronous Motor Pump Drive Operation Guidance

1) Wiring

- a. Confirm if the solar pump drive matches with the motor.
- b. Connecting “+”“-” of solar panel to R, T wiring terminals. Otherwise it will cause VFD damage.
- c. Connect motor wire and ground wire to corresponding U, V, W, E terminals.

2) Parameters setting and trial run

- a. Set F01.00 to 0, F01.02 for 0, and F01.22, F01.23 can be set according to demand.
- b. Set motor (pump) parameters according to nameplate of pump. Then Set F02.07 for 1, the keypad will show T-00, press START to start motor auto tuning. This process takes about three minutes.

Note: 1. If you can disconnect the motor and load, self-learning would be better.

2. The self-learning need to be done with enough sunshine and when the solar panels can provide enough energy.

- c. Set solar pump MPPT mode F21.00 for 1 or 2.
- d. Press FWD button for trial running, and confirm the motor running direction.

3) Common problems and solutions

- a. Q:Well-lit conditions, the pump is running, but the water is very small.
A:Check if the pump motor direction is reversed.
- b. Q:Well-lit conditions, the drive is in standby mode 0.00Hz.
A:Check F21.01, observe what protection status is the drive in currently, check whether the parameters set is reasonable.
- c. Q:DC current is incorrectly displayed.
A:Adjust F21.30, F21.31 for calibration.
- d. Q:Well-lit conditions, frequency severe beating during operation.
A:Reasonably adjust F21.06 value, the adjustment is recommended to be in the vicinity of the default, too big or too small will cause frequency oscillation.

7.3 PV Water Pump Features

1) Sleep Function

During the photovoltaic pump operation, the VFD will go into sleep state when the DC voltage provided by solar panels is lower than F21.11 (sleep voltage threshold) due to objective factors, while the keyboard warning “A.LPn”; when DC voltage provided by solar panels rises back to F21.12 (sleep recovery voltage) point, start timing and after F21.13 (sleep shutdown waiting time), the drive starts running.

2) Low-frequency Protection Function

During the operation of the photovoltaic pump, for some reason, the output frequency is lower than F21.14 (low frequency detection frequency), and after F21.15 (under frequency detection time) time, enters into the standby protection state, while the keyboard warning “A.LFr”; after entering into the standby protection state and after F21.16 (frequency protection automatic recovery) time, automatically resume to running state.

3) Dry Run Protection

During the operation of the photovoltaic pump, for some reason, the output current is less than F21.17 (dry protection current detection), and after F21.18 (dry protection detection time) time, enters into standby protection state, while the keyboard warning “A.LuT”; after entering into the standby protection state and after F21.19 (dry protection automatic recovery)time, automatically resume to running state.

4) Over-current Protection

During the operation of the photovoltaic pump, for some reason, the output current is greater than F21.20(over current point setting), and after F21.21 (over current protection detect) time, enters into standby protection state, while the keyboard warning “A.oLd”; after entering into the standby protection state and after F21.22 (over current protection auto restore working)time, automatically resume to running state.

5) Minimum Power Protection

During the operation of the photovoltaic pump, for some reason, the output power is less than F21.23(minimum power protection value), and after F21.24 (minimum power protection detection time) time, enters into standby protection state, while the keyboard warning “A.LPr”; after entering into the standby protection state and after F21.25 (minimum power automatic recovery)time, automatically resume to running state.

6) Full Water Protection

Detect the water full alarm and low water level through two X terminals, realizing automatic level control. Wherein F21.27 is the water overflow protection detection time and F21.28 is full water protection exit time, and X 3 terminal is defined as full solar water detection alarm, and X4 terminal is defined as full solar water detection alarm reset, the warning signal is shown as “A.Ful”.

7) Alarm Recovery Mode: 0: automatic recovery; 1: manual recovery

This option is for low frequency protection, dry protection, over-current protection, minimum power function; you can select the alarm restoration by F21.26. When you select 0 for automatic recovery, during fault warning displaying, you can also press the “RESET” button to stop operation; during fault warning displaying, you can press the “RESET” button to manually clear, you can also press “RESET” button to achieve stop operation.

8) PQ Curve Function

This model provides a self-defined PQ curve for users to set up five groups of PQ corresponding points according to the pump cases, to achieve real-time traffic speed, daily flow, cumulative flow, generating capacity, cumulative electricity consumption; of which by default, daily flow and generating capacity are calculated based on 7h in a day.

9) Status Check

When the photovoltaic pump is running, you can check F21.01 to confirm the current operating status.