

VEICHI AC300 (380V three phase input) Power Connections.

Notes:

The motor can be controlled either directly from the VFD control panel or via external switches connected to the digital inputs of the VFD (Green connectors at the top). If external switches are used, the VFD needs to be programmed accordingly. The CFP Technologies Remote Unit can also be used to control the VFD. (Supplied with instructions)
Never switch the power line between the VFD and motor to avoid damage to the VFD output transistors.

It is very important that the wiring from the VFD output go directly to the motor. No switching to be done in this line to avoid spikes that can damage the VFD.

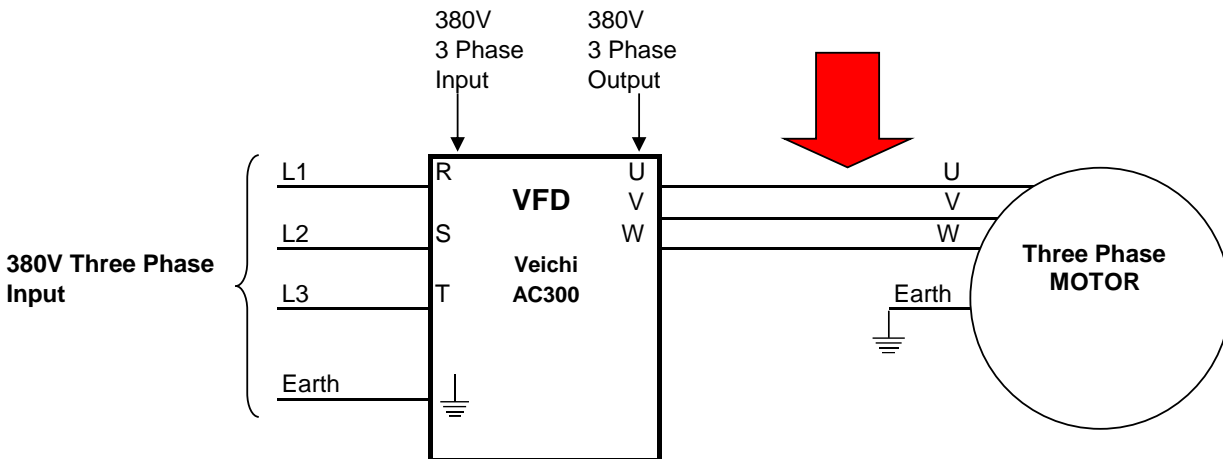

Input power to be connected to R, S & T . Input earth to be connected to earth
Output power (marked "Motor") to be connected to motor U,V & W. VFD earth

Securitek Alarms cc t/a

CFP TECHNOLOGIES

Reg. no. 1987/027414/23

P.O Box 15740

Sinoville

0129

Tel:0828570324

www.cfptechnologies.co.za